

LED Drivers for LCD Backlights

Backlight LED Driver for Small LCD Panels (Charge Pump Type)

BD1603NUV

No.11040EBT20

●Description

The high-power (large current output) type LED driver is a white LED driver best suited for applications that require the large current. It is equipped with output voltage and oscillation frequency switch functions to flexibly cope with a wide variety of applications. Because output voltage is fixed at 4.5V or 5.0V, it is also applicable to applications except the LED driver.

●Features

- 1) Selectable 4.5V or 5.0V output voltage
- 2) 190mA output (at Vo=4.5V)
- 3) 150mA output (at Vo=5.0V)
- 4) Oscillation frequency switching (238kHz or 642kHz)
- 5) Current consumption less than or equal to 2μA at shut-down
- 6) Low ripple output owing to a complementary charge pump circuit
- 7) Over current protection when VOUT short to GND.
- 8) Soft start function
- 9) Mounting various protection functions such as current overload limiter and thermal shut-down circuit
- 10) Small VSON package

●Applications

This driver is applicable for various fields such as mobile phones, portable game machines and appliances.
 5V supply for HDMI
 5V supply for USB OTG

●Lineup

Parameter	BD1603NUV
Number of LEDs	Up to 10 LEDs (Up to maximum load current)
Boost magnification	×2 fixed (4.5V or 5.0V output)
Interface	Control via external pins
Individual LED lighting	Not available
Package	VSON010V3030 3mm × 3mm

●Absolute Maximum Rating (Ta=25°C)

Parameter	Symbol	Ratings	Unit	Condition
Power supply voltage	VINMAX	7	V	
Output voltage	VOMAX	7	V	
Operating temperature range	Topr	-30 ~ +85	°C	
Storage temperature range	Tstg	-55 ~ +150	°C	
Allowable loss	Pd	700(*1)	mW	

(*1)When a glass epoxy substrate (70mm × 70mm × 1.6mm) has been mounted, this loss will decrease 5.6mW/°C if Ta is higher than or equal to 25°C.

●Operation Range (Ta=-30°C to +85°C)

Parameter	Symbol	Ratings	Unit	Condition
Operating supply voltage	Vin	2.7~5.5	V	

●Electrical Characteristics

○ Unless otherwise specified, Ta = 25°C and Vin = 3.6V.

Parameter	Symbol	Limits			Unit	Condition
		Min.	Typ.	Max.		
Input voltage range	V _{IN}	2.7	-	5.5	V	
Circuit current	I _{Q1}	-	1.4	2.0	mA	Freq=238kHz, I _{OUT} =0mA,
	I _{Q2}	-	3.0	4.2	mA	Freq=642kHz, I _{OUT} =0mA
	I _{Q3}	-	-	2	μA	EN=0V
Output voltage	V _{OUT1}	4.80	5.0	5.20	V	VSEL=V _{IN} , I _{OUT} =150mA
	V _{OUT2}	4.275	4.5	4.725	V	VSEL=0V, I _{OUT} =190mA
Output current	I _{OUT1}	-	-	150	mA	VSEL=V _{IN} 3.2V ≤ V _{IN} *1)
	I _{OUT2}	-	-	190	mA	VSEL=0V 3.2V ≤ V _{IN} *1)
	I _{OUT3}	-	-	60	mA	VSEL=V _{IN} 2.85V ≤ V _{IN} *1)
	I _{OUT4}	-	-	120	mA	VSEL=0V 2.85V ≤ V _{IN} *1)
Oscillation frequency	f _{OSC1}	-15%	238	+15%	kHz	EN=V _{IN} , FSEL=0V
	f _{OSC2}	-20%	642	+20%	kHz	EN=V _{IN} , FSEL=V _{IN}
Output short-circuit current	I _{SC}	-	-	600	mA	V _{OUT} =0V
Efficiency	n ₁	-	75.0	-	%	V _{IN} = 3.3V, V _{OUT} =5.0V I _{OUT} =60mA, Freq=238kHz
	n ₂	-	74.5	-	%	V _{IN} = 3.3V, V _{OUT} =5.0V I _{OUT} =60mA, Freq=642kHz
[Logic controller]						
High threshold voltage	V _{IH}	1.3	-	-	V	EN, VSEL and FSEL pins
Low threshold voltage	V _{IL}	-	-	0.4	V	EN, VSEL and FSEL pins
'H' level input current	I _{IH}	-	-	10	μA	EN, VSEL and FSEL pins
'L' level input current	I _{IL}	-	-	10	μA	EN, VSEL and FSEL pins

*1) Please design a VIN condition and a load current not to exceed Pd of the LSI.

●Reference Data

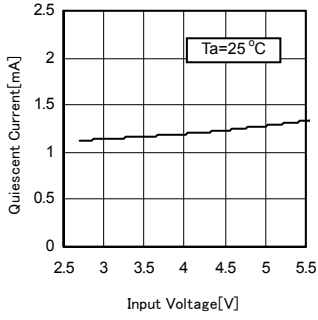

Fig.1 Quiescent Current1

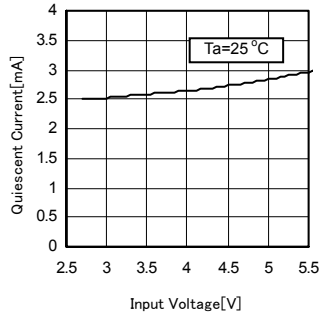

Fig.2 Quiescent Current2

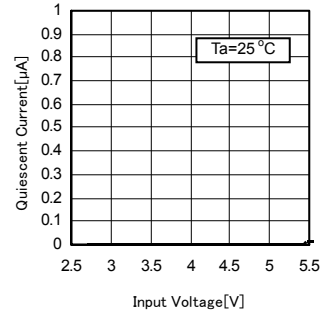

Fig.3 Quiescent Current3

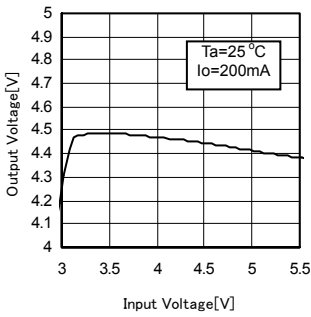

Fig.4 Line Regulation (VSEL = 0V)

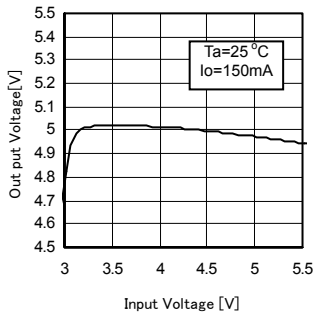

Fig.5 Line Regulation (VSEL = VIN)

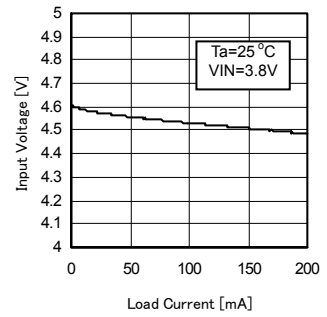

Fig.6 Load Regulation (VSEL = 0V)

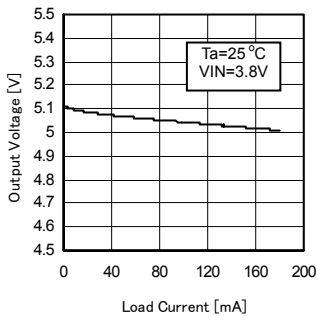

Fig.7 Load Regulation (VSEL = VIN)

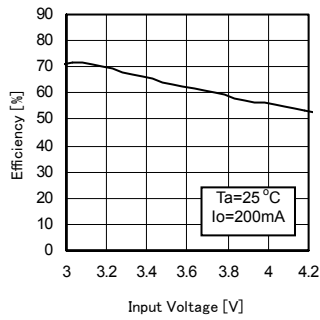

Fig.8 Efficiency vs. Input Voltage (VSEL = 0V)

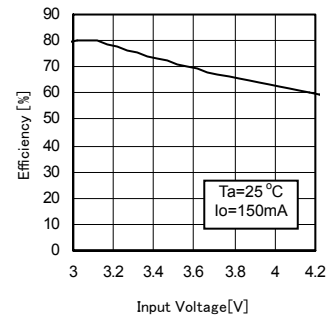

Fig.9 Efficiency vs. Input Voltage (VSEL = VIN)

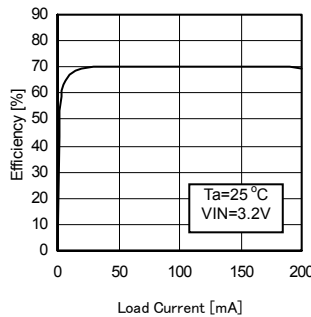

Fig.10 Efficiency vs. Load Current (VSEL = 0V)

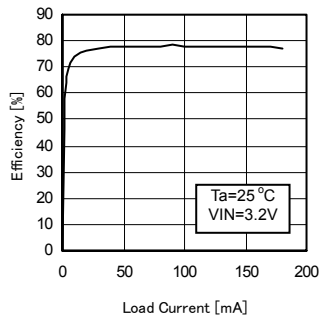

Fig.11 Efficiency vs. Load Current (VSEL = VIN)

●Block Diagram and Recommended Circuit Example

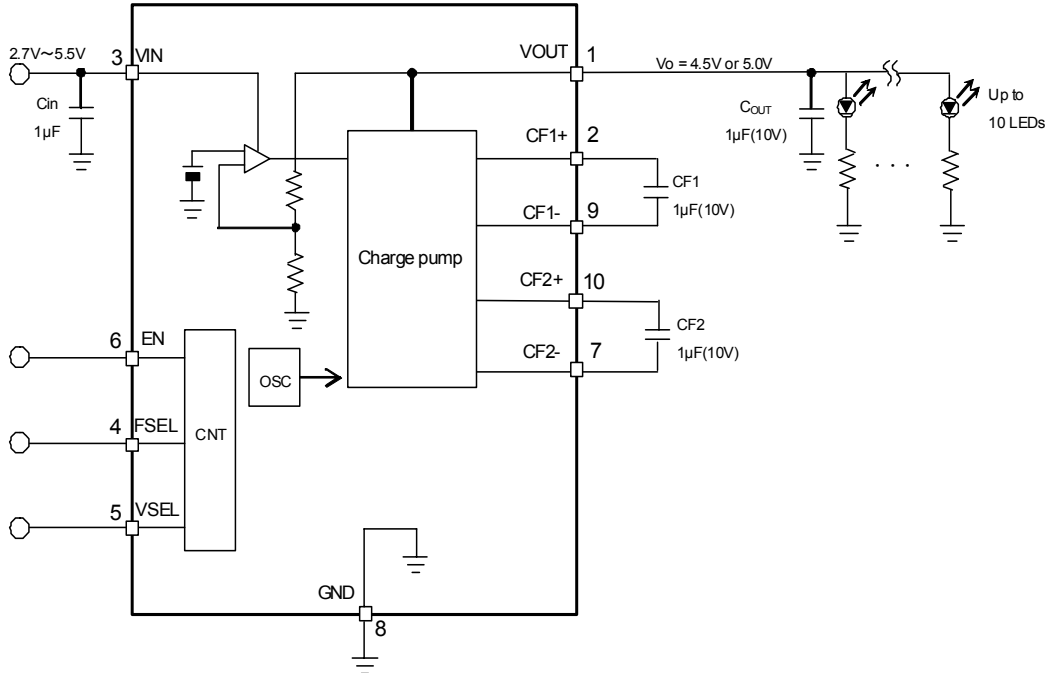

Fig.12 Example of Recommended Circuit

●Pin Table

Pin number	Pin name	In/Out	Function
1	VOUT	Out	Output pin
2	CF1+	In/Out	Connection pin for flying capacitor 1
3	VIN	In	Input voltage
4	FSEL	In	Frequency switch pin(L : 238kHz, H : 642kHz)
5	VSEL	In	Output voltage switch pin(L : 4.5V, H : 5.0V)
6	EN	In	ON/OFF control pin
7	CF2-	In/Out	Connection pin for flying capacitor 2
8	GND	-	Ground pin
9	CF1-	In/Out	Connection pin for flying capacitor 1
10	CF2+	In/Out	Connection pin for flying capacitor 2

●Description of Operations

- ON/OFF control
 ON/OFF control takes place via the external EN pin.
 EN = "H" : Operation
 EN = "L" : Standby
- Low ripple charge pump
 BD1603NUV is equipped with a complementary charge pump circuit that achieves low ripple output.
 Because BD1603NUV uses two pairs of charge switch and pump switch alternately, it can significantly reduce the output ripple in comparison with the conventional double charge pumps.
- Frequency select
 The operating frequency of a charge pump can be changed via the FSEL pin that is set to H or L.
 This operating frequency must be selected considering the influence on other devices and according to the allowable amount of ripple.

4. Efficiency

The efficiency can be obtained from the following formula:

$$\eta = \frac{V_{OUT} \times I_O}{V_{IN} \times I_{IN}} \times 100[\%]$$

V_{OUT} : Output voltage

I_O : Load current

V_{IN} : Input voltage

I_{IN} : Input current

5. Power consumption

The power consumption can be obtained from the following formula:

$$\begin{aligned} P_D &= P_{IN} - P_{OUT} \\ &= (V_{IN} \times I_{IN}) - (V_O \times I_O) \text{ [W]} \end{aligned}$$

V_{IN} and I_O must be set within an allowable loss of this LSI.

(You must set I_O [mA] that it doesn't exceed P_d of this LSI.)

Because the allowable loss greatly depends on the PCB layout, the PCB layout must be designed considering heat dissipation. In this PCB layout, the land pattern at the rear of this LSI must be directly connected to the ground plane.

6. Output short-circuit current

When the output is short-circuited to the ground, outflow current is limited for LSI protection.

Once short-circuit is cleared, normal LSI operation is resumed (automatic return).

7. Thermal shutdown

When the chip setting temperature is 185°C (typ) or more, the thermal shutdown function is activated to turn off the charge pump circuit.

When this temperature falls below to the thermal detection temperature, normal LSI operation is resumed. Accordingly, the following ON and OFF operations are repeated as thermal operations unless the primary cause is resolved.

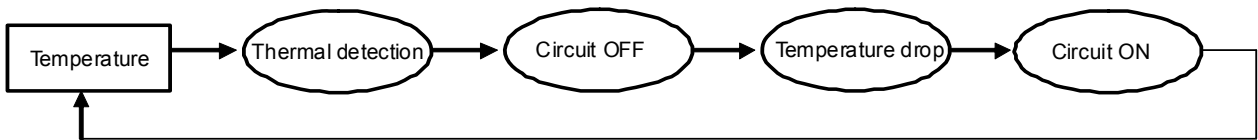

Fig.13 Thermal Detection Loop

8. Setting the LED current

The LED current is set as follows.

The constant must be determined, considering variations in resistance and LED.

$$I_{LED} = \frac{V_{OUT} - V_F}{R} \text{ [A]}$$

V_{OUT} : Output voltage of BD1603NUV

V_F : V_F in the LED to be connected

R : LED current setting resistance

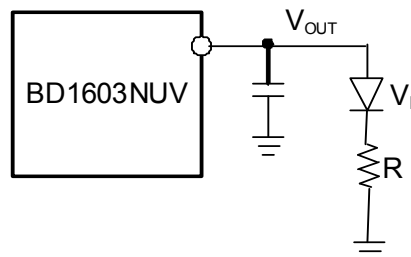

Fig.14 Setting the LED Current

9. Brightness control

Brightness control takes place in this LSI as follows.

a) PWM

The EN pin is turned ON or OFF repeatedly via the PWM signal.

It is recommended that the PWM frequency is 100Hz or below. This frequency must be determined, fully evaluating the linearity of brightness to the PWM duty. Brightness control must take place as shown in "b" below if the rush current causes a problem when the EN pin is ON.

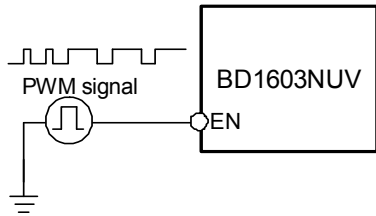

Fig.15 PWM Brightness Control

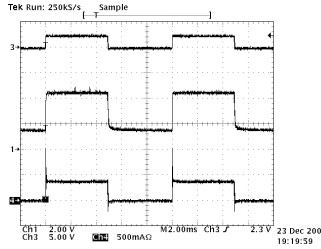

Fig.16 ON/OFF Pin Control (4.5V, 100Hz)

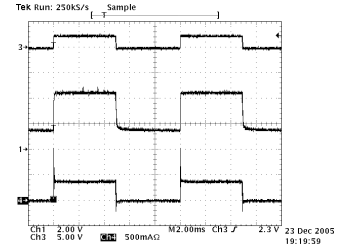

Fig.17 ON/OFF Pin Control (5.0V, 100Hz)

b) Switching the LED Current

Switching the LED current takes place via the external switch.

The constant must be determined, considering the ON resistance of the switch transistor.

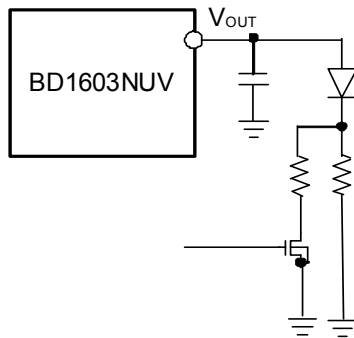

Fig18. Brightness Control via the External Transistor

10. Cautions on PCB Design

BD1603NUV is equipped with a double charge pump. As the load current becomes larger, the input current also becomes larger.

- Wire a substrate in a way that the wiring impedance can be minimized. Special care should be taken for the input voltage, ground, output and flying capacitor connection pin.
- Wire the ground of an output capacitor (C_{OUT}) near the GND pin of this LSI.
- Position a bypass capacitor to be inserted between V_{IN} (input voltage) and GND near this LSI and wire it near the V_{IN} and GND pins of this LSI.
- Heat radiation is controlled by the wiring status to the back metal. Connect it with GND plane as much as possible by a wide area.
- About the FSEL terminal and the VSEL terminal, process fixed logic by the PCB pattern when using it by fixed logic.

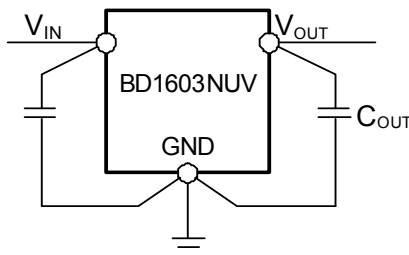
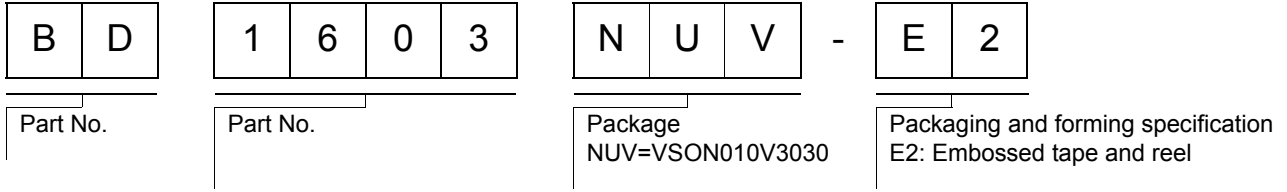

Fig19. How to Ground in PCB Design

●Notes for Use

- (1) Absolute Maximum Ratings
An excess in the absolute maximum ratings, such as supply voltage, temperature range of operating conditions, etc., can break down devices, thus making impossible to identify breaking mode such as a short circuit or an open circuit. If any special mode exceeding the absolute maximum ratings is assumed, consideration should be given to take physical safety measures including the use of fuses, etc.
- (2) Operating conditions
These conditions represent a range within which characteristics can be provided approximately as expected. The electrical characteristics are guaranteed under the conditions of each parameter.
- (3) Reverse connection of power supply connector
The reverse connection of power supply connector can break down ICs. Take protective measures against the breakdown due to the reverse connection, such as mounting an external diode between the power supply and the IC's power supply terminal.
- (4) Power supply line
Design PCB pattern to provide low impedance for the wiring between the power supply and the GND lines. Furthermore, for all power supply terminals to ICs, mount a capacitor between the power supply and the GND terminal. At the same time, in order to use an electrolytic capacitor, thoroughly check to be sure the characteristics of the capacitor to be used present no problem including the occurrence of capacity dropout at a low temperature, thus determining the constant.
- (5) GND voltage
Make setting of the potential of the GND terminal so that it will be maintained at the minimum in any operating state. Furthermore, check to be sure no terminals are at a potential lower than the GND voltage including an actual electric transient.
- (6) Short circuit between terminals and erroneous mounting
In order to mount ICs on a set PCB, pay thorough attention to the direction and offset of the ICs. Erroneous mounting can break down the ICs. Furthermore, if a short circuit occurs due to foreign matters entering between terminals or between the terminal and the power supply or the GND terminal, the ICs can break down.
- (7) Operation in strong electromagnetic field
Be noted that using ICs in the strong electromagnetic field can malfunction them.
- (8) Inspection with set PCB
On the inspection with the set PCB, if a capacitor is connected to a low-impedance IC terminal, the IC can suffer stress. Therefore, be sure to discharge from the set PCB by each process. Furthermore, in order to mount or dismount the set PCB to/from the jig for the inspection process, be sure to turn OFF the power supply and then mount the set PCB to the jig. After the completion of the inspection, be sure to turn OFF the power supply and then dismount it from the jig. In addition, for protection against static electricity, establish a ground for the assembly process and pay thorough attention to the transportation and the storage of the set PCB.
- (9) Input terminals
In terms of the construction of IC, parasitic elements are inevitably formed in relation to potential. The operation of the parasitic element can cause interference with circuit operation, thus resulting in a malfunction and then breakdown of the input terminal. Therefore, pay thorough attention not to handle the input terminals, such as to apply to the input terminals a voltage lower than the GND respectively, so that any parasitic element will operate. Furthermore, do not apply a voltage to the input terminals when no power supply voltage is applied to the IC. In addition, even if the power supply voltage is applied, apply to the input terminals a voltage lower than the power supply voltage or within the guaranteed value of electrical characteristics.
- (10) Ground wiring pattern
In terms of GND wiring, the recommended wiring is to make single-point grounding at a reference point on the set PCB. As for GND of external parts as well, please hold PCB design so that impedance may lower fully.
- (11) External capacitor
In order to use a ceramic capacitor as the external capacitor, determine the constant with consideration given to a degradation in the nominal capacitance due to DC bias and changes in the capacitance due to temperature, etc.
- (12) Thermal shutdown circuit (TSD)
When a junction temperature rises above the setting value, the thermal shutdown circuit is activated to turn off the switch. The purpose of the thermal shutdown circuit is to block LSI when an uncontrolled operation takes place for a temperature above the setting value. The thermal shutdown circuit has not been engineered to protect or assure LSI. For this reason, don't use this circuit to enable continuous use or operation of LSI.
- (13) Thermal design
Thermal design must have enough margins, considering an allowable loss (Pd) in actual usage.
- (14) About the rush current
For ICs with more than one power supply, it is possible that rush current may flow instantaneously due to the internal powering sequence and delays. Therefore, give special consideration to power coupling capacitance, power wiring, width of ground wiring, and routing of wiring.

●Ordering part number



VSON010V3030

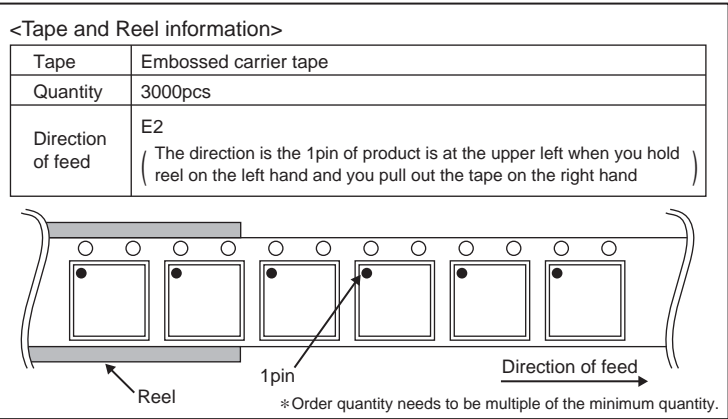
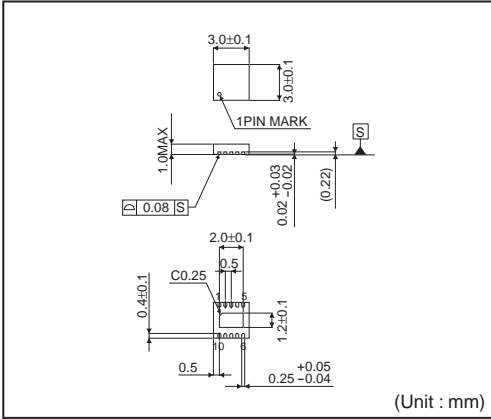

Notes

No copying or reproduction of this document, in part or in whole, is permitted without the consent of ROHM Co.,Ltd.

The content specified herein is subject to change for improvement without notice.

The content specified herein is for the purpose of introducing ROHM's products (hereinafter "Products"). If you wish to use any such Product, please be sure to refer to the specifications, which can be obtained from ROHM upon request.

Examples of application circuits, circuit constants and any other information contained herein illustrate the standard usage and operations of the Products. The peripheral conditions must be taken into account when designing circuits for mass production.

Great care was taken in ensuring the accuracy of the information specified in this document. However, should you incur any damage arising from any inaccuracy or misprint of such information, ROHM shall bear no responsibility for such damage.

The technical information specified herein is intended only to show the typical functions of and examples of application circuits for the Products. ROHM does not grant you, explicitly or implicitly, any license to use or exercise intellectual property or other rights held by ROHM and other parties. ROHM shall bear no responsibility whatsoever for any dispute arising from the use of such technical information.

The Products specified in this document are intended to be used with general-use electronic equipment or devices (such as audio visual equipment, office-automation equipment, communication devices, electronic appliances and amusement devices).

The Products specified in this document are not designed to be radiation tolerant.

While ROHM always makes efforts to enhance the quality and reliability of its Products, a Product may fail or malfunction for a variety of reasons.

Please be sure to implement in your equipment using the Products safety measures to guard against the possibility of physical injury, fire or any other damage caused in the event of the failure of any Product, such as derating, redundancy, fire control and fail-safe designs. ROHM shall bear no responsibility whatsoever for your use of any Product outside of the prescribed scope or not in accordance with the instruction manual.

The Products are not designed or manufactured to be used with any equipment, device or system which requires an extremely high level of reliability the failure or malfunction of which may result in a direct threat to human life or create a risk of human injury (such as a medical instrument, transportation equipment, aerospace machinery, nuclear-reactor controller, fuel-controller or other safety device). ROHM shall bear no responsibility in any way for use of any of the Products for the above special purposes. If a Product is intended to be used for any such special purpose, please contact a ROHM sales representative before purchasing.

If you intend to export or ship overseas any Product or technology specified herein that may be controlled under the Foreign Exchange and the Foreign Trade Law, you will be required to obtain a license or permit under the Law.



Thank you for your accessing to ROHM product informations.
More detail product informations and catalogs are available, please contact us.

ROHM Customer Support System

<http://www.rohm.com/contact/>