

## Standard Variable Output LDO Regulators

# 1A Standard Variable Output LDO Regulators



BD00C0AWFP,BD00C0AWCP-V5

No.11023EBT03

**●Description**

The BD00C0AW Series is low-saturation regulators. The output voltage can be arbitrarily configured using the external resistance. This IC has a built-in over-current protection circuit that prevents the destruction of the IC due to output short circuits and a thermal shutdown circuit that protects the IC from thermal damage due to overloading.

**●Features**

- 1) Output Current: 1A
- 2) High Output Voltage Precision :  $\pm 1\%$
- 3) Low saturation with PDMOS output
- 4) Built-in over-current protection circuit that prevents the destruction of the IC due to output short circuits
- 5) Built-in thermal shutdown circuit for protecting the IC from thermal damage due to overloading
- 6) Low ESR Capacitor
- 7) TO252-5,TO220CP-V5 packaging

**●Applications**

Audiovisual equipments, FPDs, televisions, personal computers or any other consumer device

**●Absolute maximum ratings (Ta=25°C)**

Parameter	Symbol	Ratings	Unit
Supply Voltage	V <sub>CC</sub>	-0.3 ~ +35.0	V
Output Control Voltage	V <sub>CTL</sub>	-0.3 ~ +35.0	V
Power Dissipation (TO252-5)	P <sub>d</sub>	1.3	W
Power Dissipation (TO220CP-V5) <sup>*3</sup>	P <sub>d</sub>	1.85	W
Operating Temperature Range	T <sub>opr</sub>	-40 ~ +105	°C
Storage Temperature Range	T <sub>stg</sub>	-55 ~ +150	°C
Maximum Junction Temperature	T <sub>jmax</sub>	+150	°C

\*1 Not to exceed P<sub>d</sub>.

\*2 TO252-5:Reduced by 10.4mW / °C over Ta = 25°C, when mounted on glass epoxy board: 70mm × 70mm × 1.6mm.

\*3 TO220CP-V5:Reduced by 14.8mW / °C over Ta = 25°C, when It's without Aluminium heat dissipation board.

NOTE : This product is not designed for protection against radioactive rays.

**●Operating conditions (Ta=25°C)**

Parameter	Symbol	Min.	Max.	Unit
Supply Voltage	V <sub>CC</sub>	4.0	26.5	V
Output Control Voltage	V <sub>CTL</sub>	0	26.5	V
Output Current	I <sub>o</sub>	0	1.0	A
Output Voltage	V <sub>o</sub>	3.0	15.0	V

### ●Electrical characteristics

Unless otherwise specified, Ta=25°C, Vcc=10V, V<sub>CTL</sub>=5V, I<sub>o</sub>=0mA, V<sub>o</sub>=5.0V setting

(The resistor of between ADJ and V<sub>o</sub> =56.7kΩ ,ADJ and GND =10kΩ )

Parameter	Symbol	Min.	Typ.	Max.	Unit	Conditions
Shut Down Current	I <sub>sd</sub>	—	0	10	μA	V <sub>CTL</sub> =0V
Bias Current	I <sub>b</sub>	—	0.5	1.0	mA	
ADJ Terminal Voltage	V <sub>ADJ</sub>	0.742	0.750	0.758	V	I <sub>o</sub> =50mA
Dropout Voltage	ΔV <sub>d</sub>	—	0.3	0.5	V	V <sub>cc</sub> =V <sub>o</sub> × 0.95, I <sub>o</sub> =500mA
Ripple Rejection	R.R.	45	55	—	dB	f=120Hz, e <sub>in</sub> <sup>*1</sup> =1Vrms, I <sub>o</sub> =100mA
Line Regulation	Reg.I	—	20	60	mV	V <sub>cc</sub> =6→25V
Load Regulation	Reg.L	—	V <sub>o</sub> × 0.010	V <sub>o</sub> × 0.015	V	I <sub>o</sub> =5mA→1A
Temperature Coefficient of Output Voltage	T <sub>cvo.1</sub>	—	+0.04	—	%/°C	I <sub>o</sub> =5mA, T <sub>j</sub> =-40 ~ -20°C
	T <sub>cvo.2</sub>	—	±0.005	—	%/°C	I <sub>o</sub> =5mA, T <sub>j</sub> =-20 ~ +105°C
CTL ON Mode Voltage	V <sub>thH</sub>	2.0	—	—	V	ACTIVE MODE
CTL OFF Mode Voltage	V <sub>thL</sub>	—	—	0.8	V	OFF MODE
CTL Bias Current	I <sub>CTL</sub>	—	25	50	μA	

\*1 e<sub>in</sub> : Input Voltage Ripple

●Electrical characteristic curves (Reference data)

Unless otherwise specified,  $T_a=25^{\circ}\text{C}$ ,  $V_{cc}=10\text{V}$ ,  $V_{CTL}=5\text{V}$ ,  $I_o=0\text{mA}$ ,  $V_o=5.0\text{V}$  setting  
 (The resistor of between ADJ and  $V_o = 56.7\text{k}\Omega$ , ADJ and GND =  $10\text{k}\Omega$ )

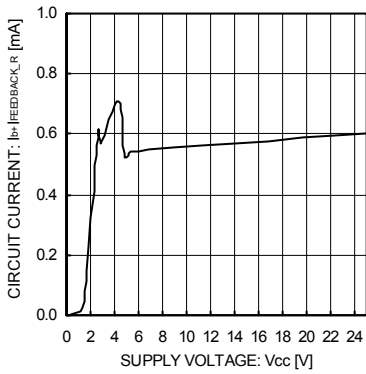

Fig.1 Circuit Current  
 ( $I_{FEEDBACK\_R} \doteq 75\mu\text{A}$ )

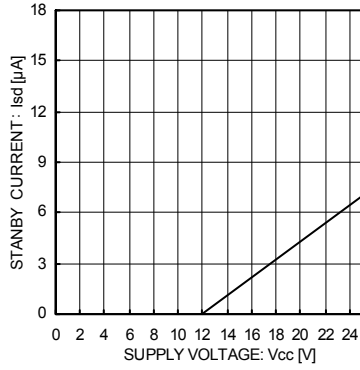

Fig.2 Shut Down Current

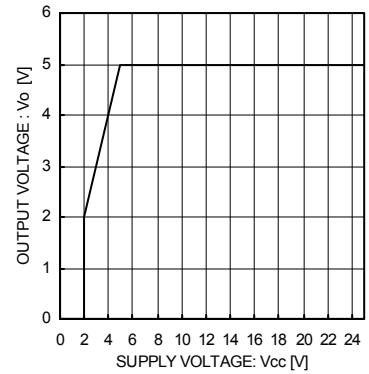

Fig.3 Line Regulation  
 ( $I_o=0\text{mA}$ )

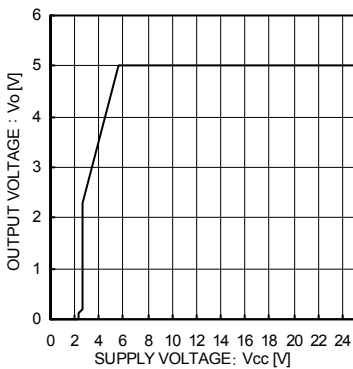

Fig.4 Line Regulation  
 ( $I_o=500\text{mA}$ )

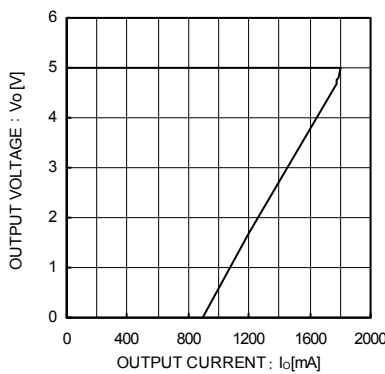

Fig.5 Load Regulation

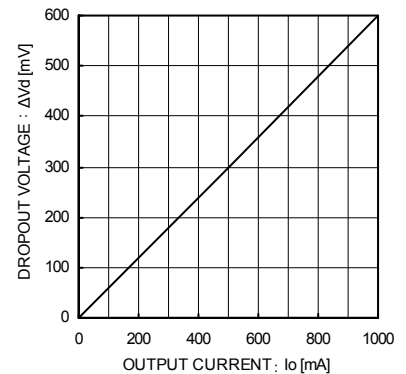

Fig.6 Dropout Voltage  
 ( $V_{cc}=4.75\text{V}$ )  
 ( $I_o=0\text{mA} \rightarrow 1000\text{mA}$ )

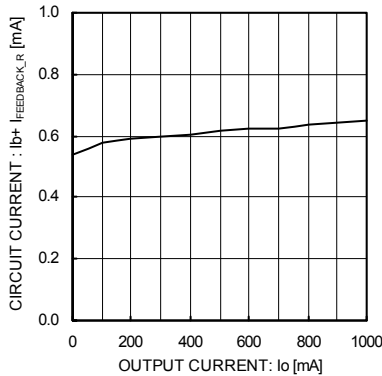

Fig.7 Ripple Rejection  
 ( $I_o=100\text{mA}$ )

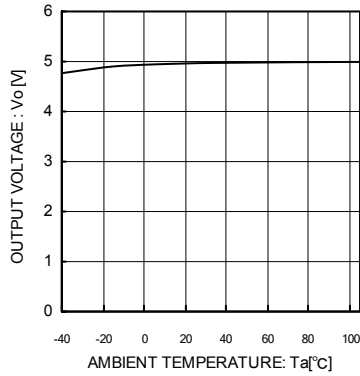

Fig.8 Output Voltage  
 Temperature Characteristics

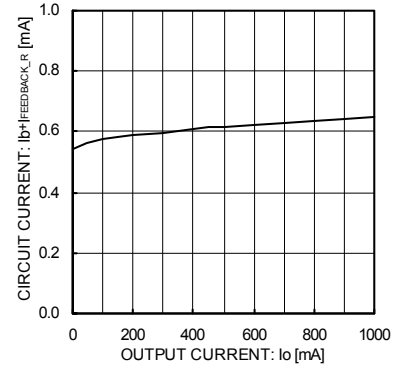

Fig.9 Circuit Current  
 ( $I_o=0\text{mA} \rightarrow 1000\text{mA}$ )  
 ( $I_{FEEDBACK\_R} \doteq 75\mu\text{A}$ )

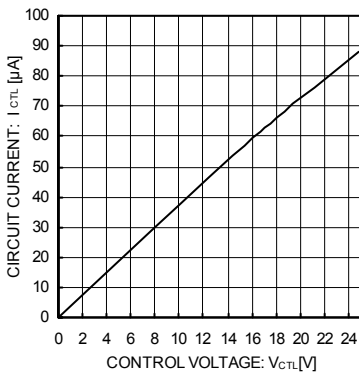

Fig.10 CTL Voltage vs CTL Current

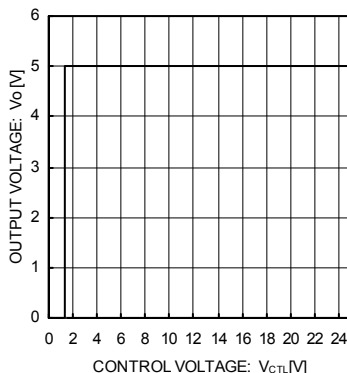

Fig.11 CTL Voltage vs Output Voltage

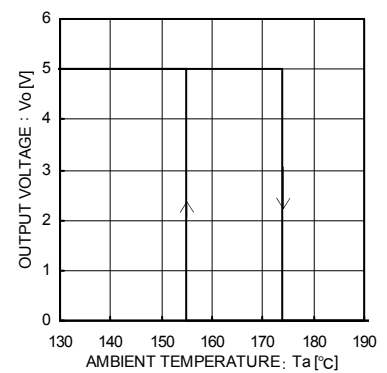
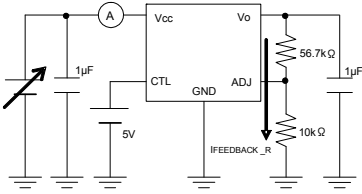
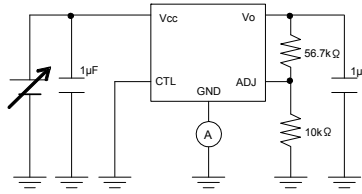

Fig.12 Thermal Shutdown  
 Circuit Characteristics

● Measurement circuit for reference data



Measurement Circuit of Fig.1



Measurement Circuit of Fig.2

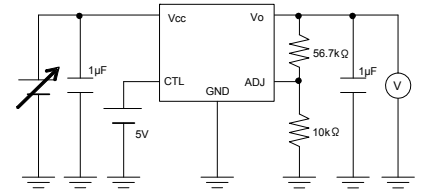

Measurement Circuit of Fig.3

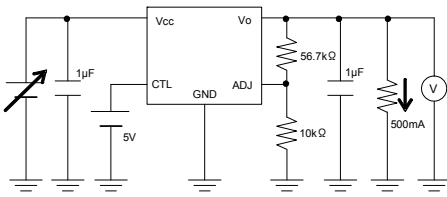

Measurement Circuit of Fig.4

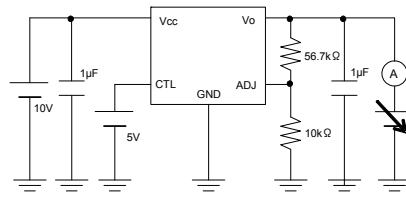

Measurement Circuit of Fig.5

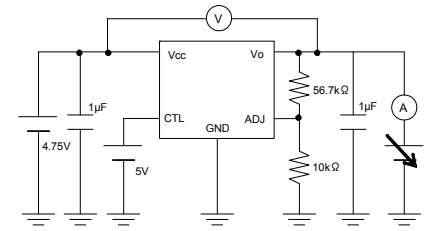

Measurement Circuit of Fig.6

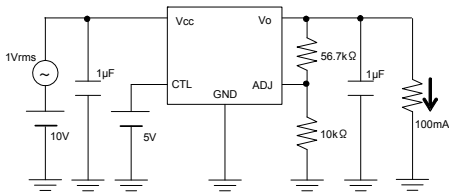

Measurement Circuit of Fig.7

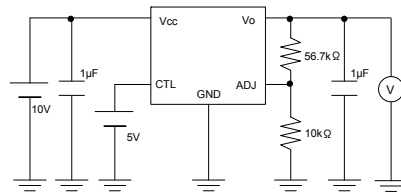

Measurement Circuit of Fig.8

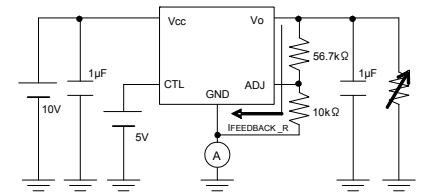

Measurement Circuit of Fig.9

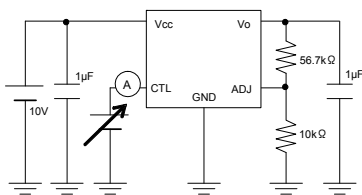

Measurement Circuit of Fig.10

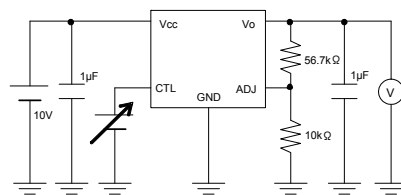

Measurement Circuit of Fig.11

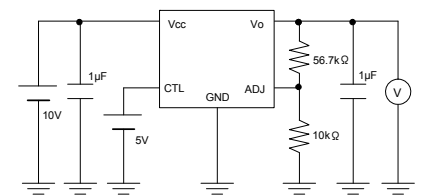

Measurement Circuit of Fig.12



●Input / Output Equivalent Circuit Diagrams

Vcc Pin

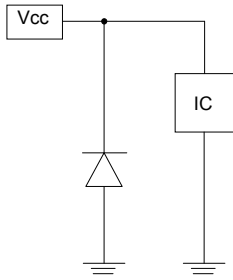

CTL Pin

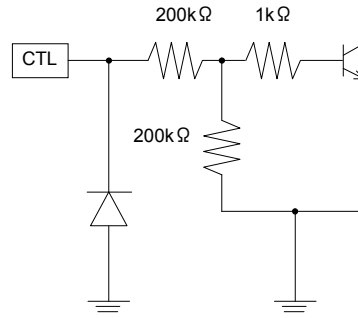

Vo Pin

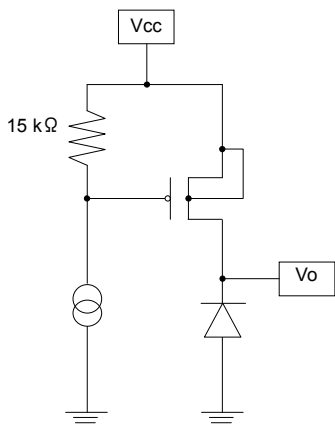

ADJ Pin

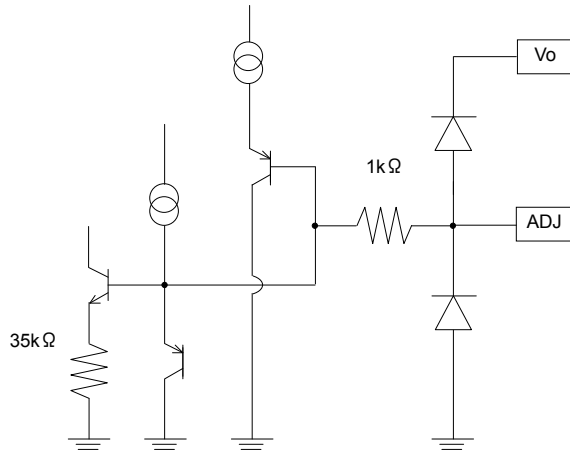

●Output Voltage Configuration Method

Please connect resistors R1 and R2 (which determines the output voltage) as shown in Fig.14. Please be aware that the offset due to the current that flows from the ADJ terminal becomes large when resistors with large values are used. The use of resistors with R1=5kΩ to 10kΩ is recommended.

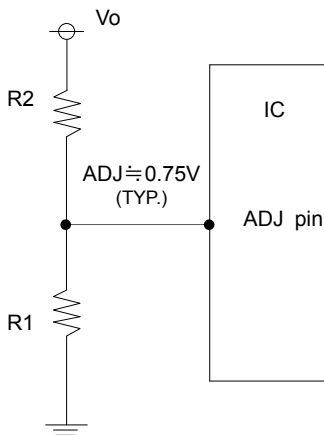

$$V_o \cong ADJ \times (R1+R2) / R1$$

Fig.14

● Thermal Design

TO252-5

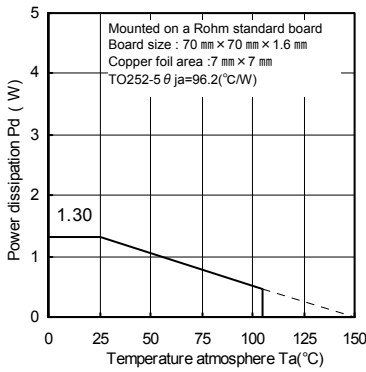

Fig.15

TO252-5

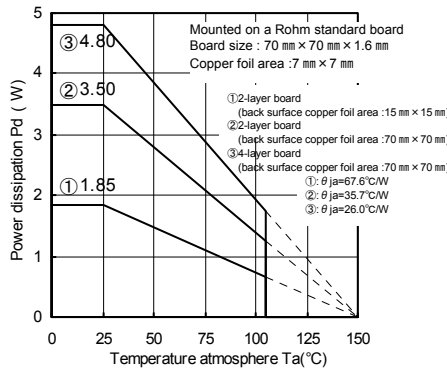

Fig.16(Reference data)

TO220CP-V5

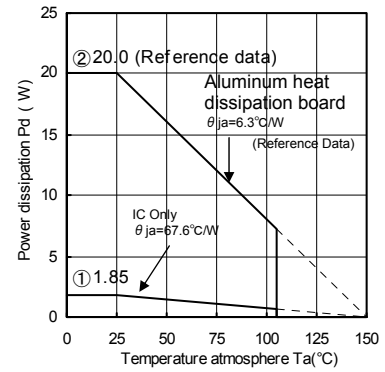

Fig.17

When using at temperatures over Ta=25°C, please refer to the heat reducing characteristics shown in Fig.15 and Fig.16. The IC characteristics are closely related to the temperature at which the IC is used, so it is necessary to operate the IC at temperatures less than the maximum junction temperature Tjmax.

Fig.15 and Fig.16 shows the acceptable loss and heat reducing characteristics of the TO252-5 package. Even when the ambient temperature Ta is a normal temperature (25°C), the chip (junction) temperature Tj may be quite high so please operate the IC at temperatures less than the acceptable loss Pd.

The calculation method for power consumption Pc(W) is as follows :(Fig.16③ and Fig.17)

$$Pc=(Vcc-Vo) \times Io+Vcc \times Ib$$

$$\text{Acceptable loss } Pd \geq Pc$$

- Vcc: Input voltage
- Vo: Output voltage
- Io: Load current
- Ib: Circuit current
- Ishort: Short current

Solving this for load current Io in order to operate within the acceptable loss,

$$Io \leq \frac{Pd - Vcc \times Ib}{Vcc - Vo} \quad (\text{Please refer to Fig.9 for } Ib.)$$

It is then possible to find the maximum load current IoMax with respect to the applied voltage Vcc at the time of thermal design.

Calculation Example) When TO252-5, Ta=85°C, Vcc=10V, Vo=5V

$$Io \leq \frac{2.496 - 10 \times Ib}{5} \quad \left[ \begin{array}{l} \text{Fig.16③: } \theta_{ja}=26.0^{\circ}\text{C/W} \rightarrow -38.4\text{mW}/^{\circ}\text{C} \\ 25^{\circ}\text{C}=4.80\text{W} \rightarrow 85^{\circ}\text{C}=2.496\text{W} \end{array} \right]$$

$$Io \leq 498.2\text{mA} \quad (Ib:0.5\text{mA})$$

Calculation Example) When TO220CP-V5, Ta=85°C, Vcc=25V, Vo=5V

$$Io \leq \frac{10.4 - 25 \times Ib}{20} \quad \left[ \begin{array}{l} \text{Fig.17(Aluminium heat dissipation board)} \theta_{ja}=6.3^{\circ}\text{C/W} \rightarrow -160\text{mW}/^{\circ}\text{C} \\ 25^{\circ}\text{C}=20\text{W} \rightarrow 85^{\circ}\text{C}=10.4\text{W} \end{array} \right]$$

$$Io \leq 519.4\text{mA} \quad (Ib:0.5\text{mA})$$

Please refer to the above information and keep thermal designs within the scope of acceptable loss for all operating temperature ranges. The power consumption Pc of the IC when there is a short circuit (short between Vo and GND) is :

$$Pc=Vcc \times (Ib+Ishort) \quad (\text{Please refer to Fig.5 for } Ishort.)$$

## ●Notes for use

1. Absolute maximum ratings  
Use of the IC in excess of absolute maximum ratings (such as the input voltage or operating temperature range) may result in damage to the IC. Assumptions should not be made regarding the state of the IC (e.g., short mode or open mode) when such damage is suffered. If operational values are expected to exceed the maximum ratings for the device, consider adding protective circuitry (such as fuses) to eliminate the risk of damaging the IC.
2. Electrical characteristics described in these specifications may vary, depending on temperature, supply voltage, external circuits and other conditions. Therefore, be sure to check all relevant factors, including transient characteristics.
3. GND potential  
The potential of the GND pin must be the minimum potential in the system in all operating conditions. Ensure that no pins are at a voltage below the GND at any time, regardless of transient characteristics.
4. Ground wiring pattern  
When using both small-signal and large-current GND traces, the two ground traces should be routed separately but connected to a single ground potential within the application in order to avoid variations in the small-signal ground caused by large currents. Also ensure that the GND traces of external components do not cause variations on GND voltage. The power supply and ground lines must be as short and thick as possible to reduce line impedance.
5. Inter-pin shorts and mounting errors  
Use caution when orienting and positioning the IC for mounting on printed circuit boards. Improper mounting may result in damage to the IC. Shorts between output pins or between output pins and the power supply or GND pins (caused by poor soldering or foreign objects) may result in damage to the IC.
6. Operation in strong electromagnetic fields  
Using this product in strong electromagnetic fields may cause IC malfunction. Caution should be exercised in applications where strong electromagnetic fields may be present.
7. Testing on application boards  
When testing the IC on an application board, connecting a capacitor directly to a low-impedance pin may subject the IC to stress. Always discharge capacitors completely after each process or step. The IC's power supply should always be turned off completely before connecting or removing it from a jig or fixture during the evaluation process. To prevent damage from static discharge, ground the IC during assembly and use similar precautions during transport and storage.
8. Thermal consideration  
Use a thermal design that allows for a sufficient margin in light of the Pd in actual operating conditions. Consider Pc that does not exceed Pd in actual operating conditions. ( $P_d \geq P_c$ )
 

$$\left( \begin{array}{l} T_{jmax} : \text{Maximum junction temperature} = 150[^\circ\text{C}] , T_a : \text{Peripheral temperature}[^\circ\text{C}] , \\ \theta_{ja} : \text{Thermal resistance of package-ambience}[^\circ\text{C}/\text{W}] , P_d : \text{Package Power dissipation [W]} , \\ P_c : \text{Power dissipation [W]} , V_{cc} : \text{Input Voltage} , V_o : \text{Output Voltage} , I_o : \text{Load} , I_b : \text{Bias Current} \end{array} \right)$$

Package Power dissipation :  $P_d (W) = (T_{jmax} - T_a) / \theta_{ja}$   
 Power dissipation :  $P_c (W) = (V_{cc} - V_o) \times I_o + V_{cc} \times I_b$
9. Vcc pin  
Insert a capacitor ( $V_o \geq 5V$ : capacitor  $\geq 1\mu\text{F}$  ~ ,  $V_o < 5V$ : capacitor  $\geq 2.2\mu\text{F}$  ~ ) between the Vcc and GND pins. The appropriate capacitance value varies by application. Be sure to allow a sufficient margin for input voltage levels.

## Electric capacitance

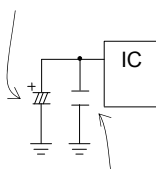

Ceramic capacitors, Low ESR capacitors



10. Output pin

It is necessary to place capacitors between each output pin and GND to prevent oscillation on the output. Usable capacitance values range from 1μF to 1000μF. Ceramic capacitors can be used as long as their ESR value is low enough to prevent oscillation (0.001Ω to 20Ω). Abrupt fluctuations in input voltage and load conditions may affect the output voltage. Output capacitance values should be determined only through sufficient testing of the actual application.

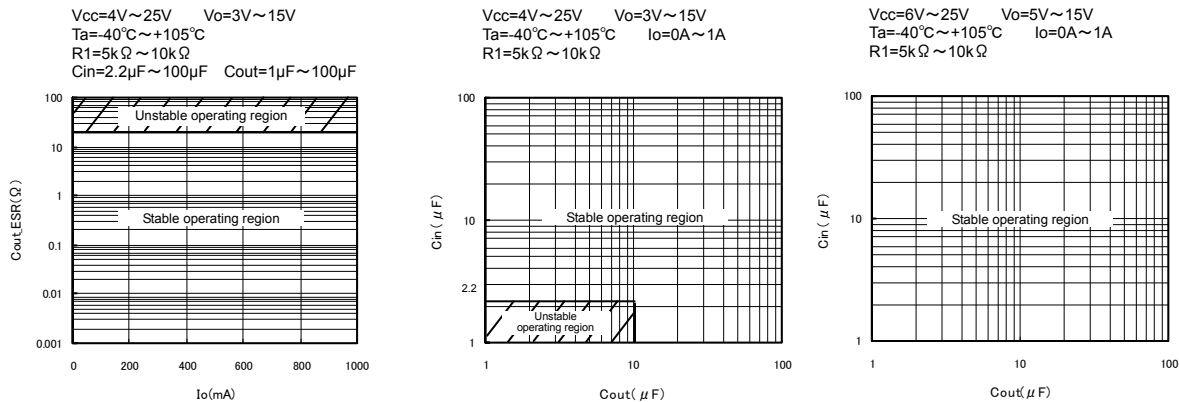

Cout\_ESR vs Io(reference data)

Cin vs Cout(reference data)

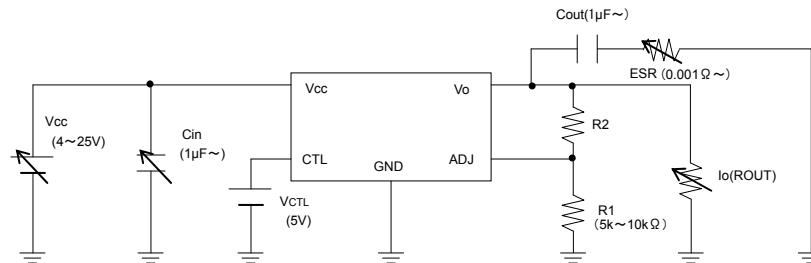

※Operation Notes 10 Measurement circuit

11. CTL pin

Do not make voltage level of chip enable pin keep floating level, or in between VthH and VthL. Otherwise, the output voltage would be unstable or indefinite.

12. For a steep change of the Vcc voltage

Because MOS FET for output Transistor is used when an input voltage change is very steep, it may evoke large current. When selecting the value of external circuit constants, please make sure that the operation on the actual application takes these conditions into account.

13. For an infinitesimal fluctuations of output voltage.

At the use of the application that infinitesimal fluctuations of output voltage caused by some factors (e.g. disturbance noise, input voltage fluctuations, load fluctuations, etc.), please take enough measures to avoid some influence (e.g. insert the filter, etc.).

14. Over current protection circuit (OCP)

The IC incorporates an integrated over-current protection circuit that operates in accordance with the rated output capacity. This circuit serves to protect the IC from damage when the load becomes shorted. It is also designed to limit output current (without latching) in the event of a large and instantaneous current flow from a large capacitor or other component. These protection circuits are effective in preventing damage due to sudden and unexpected accidents. However, the IC should not be used in applications characterized by the continuous or transitive operation of the protection circuits.

15. Thermal shutdown circuit (TSD)

The IC incorporates a built-in thermal shutdown circuit, which is designed to turn the IC off completely in the event of thermal overload. It is not designed to protect the IC from damage or guarantee its operation. ICs should not be used after this function has activated, or in applications where the operation of this circuit is assumed.

16. Applications or inspection processes where the potential of the Vcc pin or other pins may be reversed from their normal state may cause damage to the IC's internal circuitry or elements. Use an output pin capacitance of 1000µF or lower in case Vcc is shorted with the GND pin while the external capacitor is charged. Insert a diode in series with Vcc to prevent reverse current flow, or insert bypass diodes between Vcc and each pin.

17. Positive voltage surges on VCC pin

A power zener diode should be inserted between VCC and GND for protection against voltage surges of more than 35V on the VCC pin.

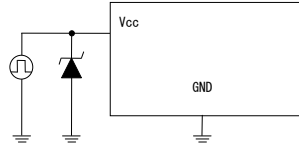

18. Negative voltage surges on VCC pin

A schottky barrier diode should be inserted between VCC and GND for protection against voltages lower than GND on the VCC pin.

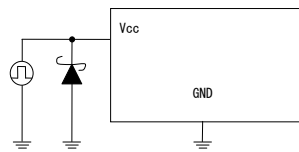

19. Output protection diode

Loads with large inductance components may cause reverse current flow during startup or shutdown. In such cases, a protection diode should be inserted on the output to protect the IC.

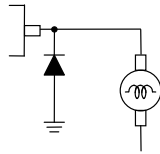

20. Regarding input pins of the IC

This monolithic IC contains P+ isolation and P substrate layers between adjacent elements in order to keep them isolated. PN junctions are formed at the intersection of these P layers with the N layers of other elements, creating parasitic diodes and/or transistors. For example (refer to the figure below):

- When GND > Pin A and GND > Pin B, the PN junction operates as a parasitic diode
- When GND > Pin B, the PN junction operates as a parasitic transistor

Parasitic diodes occur inevitably in the structure of the IC, and the operation of these parasitic diodes can result in mutual interference among circuits, operational faults, or physical damage. Accordingly, conditions that cause these diodes to operate, such as applying a voltage lower than the GND voltage to an input pin (and thus to the P substrate) should be avoided.

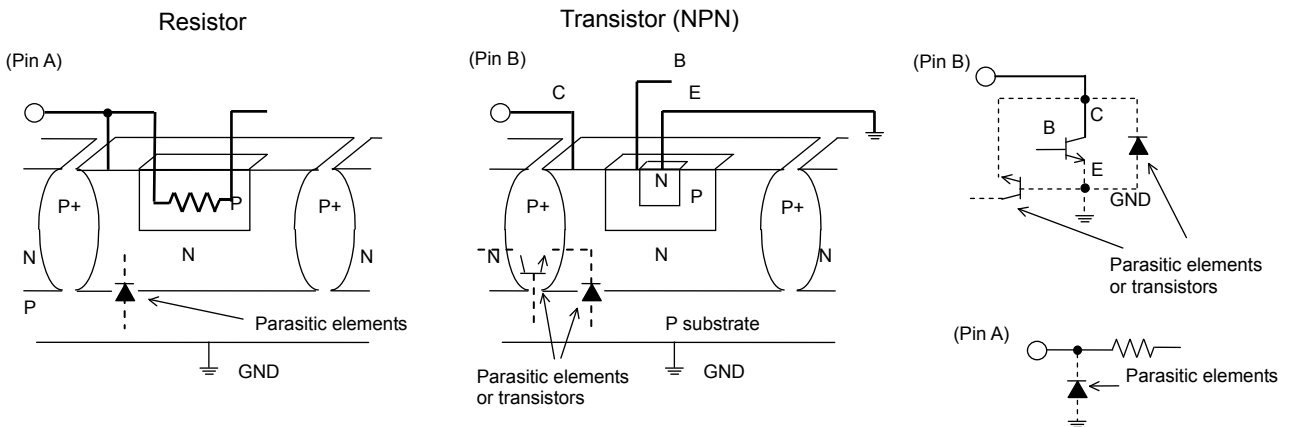

Example of Simple Monolithic IC Architecture

●Ordering part number

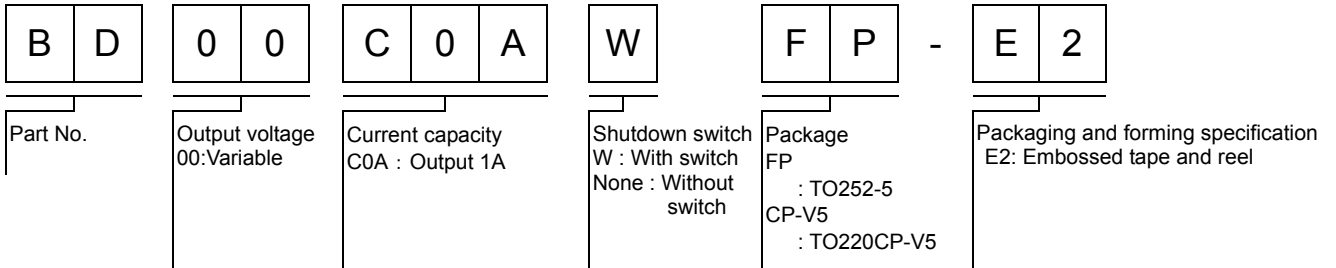

TO252-5

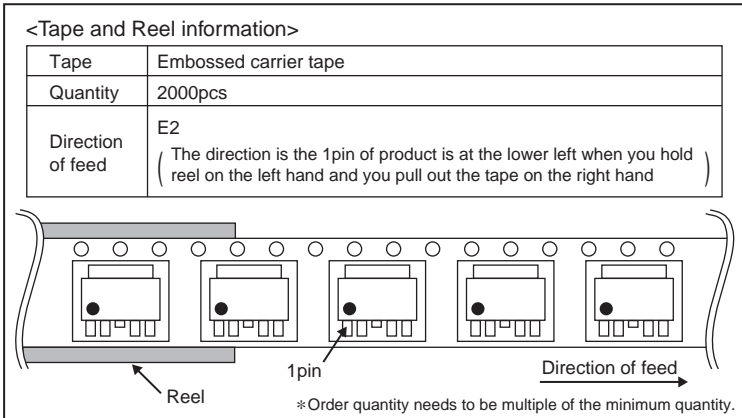
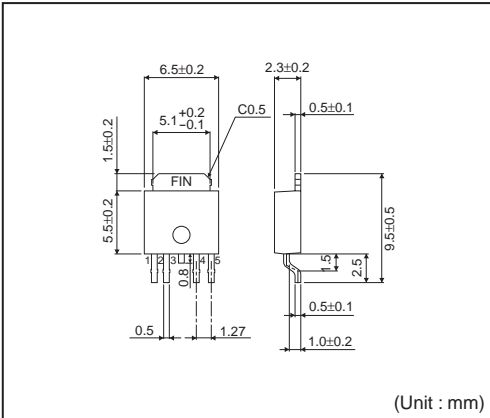

TO220CP-V5

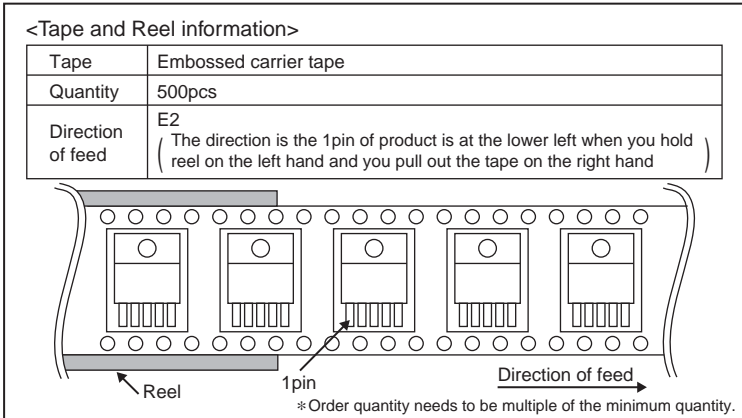
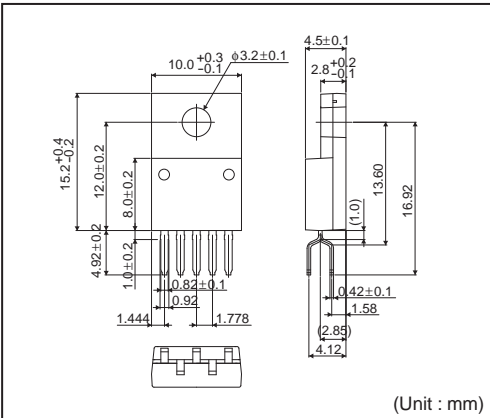

## Notes

No copying or reproduction of this document, in part or in whole, is permitted without the consent of ROHM Co.,Ltd.

The content specified herein is subject to change for improvement without notice.

The content specified herein is for the purpose of introducing ROHM's products (hereinafter "Products"). If you wish to use any such Product, please be sure to refer to the specifications, which can be obtained from ROHM upon request.

Examples of application circuits, circuit constants and any other information contained herein illustrate the standard usage and operations of the Products. The peripheral conditions must be taken into account when designing circuits for mass production.

Great care was taken in ensuring the accuracy of the information specified in this document. However, should you incur any damage arising from any inaccuracy or misprint of such information, ROHM shall bear no responsibility for such damage.

The technical information specified herein is intended only to show the typical functions of and examples of application circuits for the Products. ROHM does not grant you, explicitly or implicitly, any license to use or exercise intellectual property or other rights held by ROHM and other parties. ROHM shall bear no responsibility whatsoever for any dispute arising from the use of such technical information.

The Products specified in this document are intended to be used with general-use electronic equipment or devices (such as audio visual equipment, office-automation equipment, communication devices, electronic appliances and amusement devices).

The Products specified in this document are not designed to be radiation tolerant.

While ROHM always makes efforts to enhance the quality and reliability of its Products, a Product may fail or malfunction for a variety of reasons.

Please be sure to implement in your equipment using the Products safety measures to guard against the possibility of physical injury, fire or any other damage caused in the event of the failure of any Product, such as derating, redundancy, fire control and fail-safe designs. ROHM shall bear no responsibility whatsoever for your use of any Product outside of the prescribed scope or not in accordance with the instruction manual.

The Products are not designed or manufactured to be used with any equipment, device or system which requires an extremely high level of reliability the failure or malfunction of which may result in a direct threat to human life or create a risk of human injury (such as a medical instrument, transportation equipment, aerospace machinery, nuclear-reactor controller, fuel-controller or other safety device). ROHM shall bear no responsibility in any way for use of any of the Products for the above special purposes. If a Product is intended to be used for any such special purpose, please contact a ROHM sales representative before purchasing.

If you intend to export or ship overseas any Product or technology specified herein that may be controlled under the Foreign Exchange and the Foreign Trade Law, you will be required to obtain a license or permit under the Law.



Thank you for your accessing to ROHM product informations.  
More detail product informations and catalogs are available, please contact us.

### ROHM Customer Support System

<http://www.rohm.com/contact/>