

### PNP Silicon

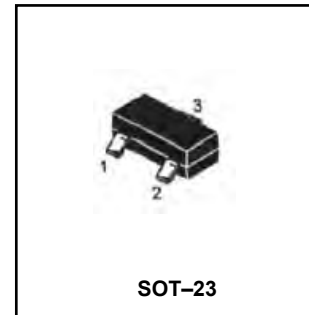
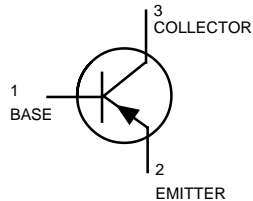
#### Features

We declare that the material of product compliance with RoHS requirements.

**Pb-Free package is available**

RoHS product for packing code suffix "G"

Halogen free product for packing code suffix "H"



#### MAXIMUM RATINGS

Rating	Symbol	Value	Unit
Collector-Emitter Voltage	$V_{CEO}$	- 45	Vdc
Emitter-Base Voltage	$V_{EBO}$	- 5.0	Vdc
Collector Current — Continuous	$I_C$	- 100	mAdc

#### THERMAL CHARACTERISTICS

Characteristic	Symbol	Max	Unit
Total Device Dissipation FR-5 Board, (1) $T_A = 25^\circ\text{C}$	$P_D$	225	mW
Derate above $25^\circ\text{C}$		1.8	mW/ $^\circ\text{C}$
Thermal Resistance, Junction to Ambient	$R_{\theta JA}$	556	$^\circ\text{C}/\text{W}$
Total Device Dissipation Alumina Substrate, (2) $T_A = 25^\circ\text{C}$	$P_D$	300	mW
Derate above $25^\circ\text{C}$		2.4	mW/ $^\circ\text{C}$
Thermal Resistance, Junction to Ambient	$R_{\theta JA}$	417	$^\circ\text{C}/\text{W}$
Junction and Storage Temperature	$T_J, T_{stg}$	-55 to +150	$^\circ\text{C}$

#### DEVICE MARKING

BCW69LT1 = H1; BCW70LT1 = H2

#### ELECTRICAL CHARACTERISTICS ( $T_A = 25^\circ\text{C}$ unless otherwise noted.)

Characteristic	Symbol	Min	Max	Unit
----------------	--------	-----	-----	------

#### OFF CHARACTERISTICS

Collector-Emitter Breakdown Voltage ( $I_C = -2.0 \text{ mAdc}, I_B = 0$ )	$V_{(BR)CEO}$	- 45	—	Vdc
Collector-Emitter Breakdown Voltage ( $I_C = -100 \mu\text{Adc}, V_{EB} = 0$ )	$V_{(BR)CES}$	- 50	—	Vdc
Emitter-Base Breakdown Voltage ( $I_E = -10 \mu\text{Adc}, I_C = 0$ )	$V_{(BR)EBO}$	- 5.0	—	Vdc
Collector Cutoff Current	$I_{CEO}$			
( $V_{CE} = -20 \text{ Vdc}, I_E = 0$ )		—	- 100	nAdc
( $V_{CE} = -20 \text{ Vdc}, I_E = 0, T_A = 100^\circ\text{C}$ )		—	- 10	$\mu\text{Adc}$

1. FR-5 = 1.0 x 0.75 x 0.062 in.

2. Alumina = 0.4 x 0.3 x 0.024 in. 99.5% alumina.

**ELECTRICAL CHARACTERISTICS** ( $T_A = 25^\circ\text{C}$  unless otherwise noted) (Continued)

Characteristic	Symbol	Min	Max	Unit
----------------	--------	-----	-----	------

**ON CHARACTERISTICS**

DC Current Gain ( $I_C = -2.0 \text{ mAdc}$ , $V_{CE} = -5.0 \text{ Vdc}$ )	$h_{FE}$			—
BCW69LT1		120	260	
BCW70LT1		215	500	
Collector–Emitter Saturation Voltage ( $I_C = -10 \text{ mAdc}$ , $I_B = -0.5 \text{ mAdc}$ )	$V_{CE(sat)}$	—	- 0.3	Vdc
Base–Emitter On Voltage ( $I_C = -2.0 \text{ mAdc}$ , $V_{CE} = -5.0 \text{ Vdc}$ )	$V_{BE(on)}$	- 0.6	- 0.75	Vdc

**SMALL–SIGNAL CHARACTERISTICS**

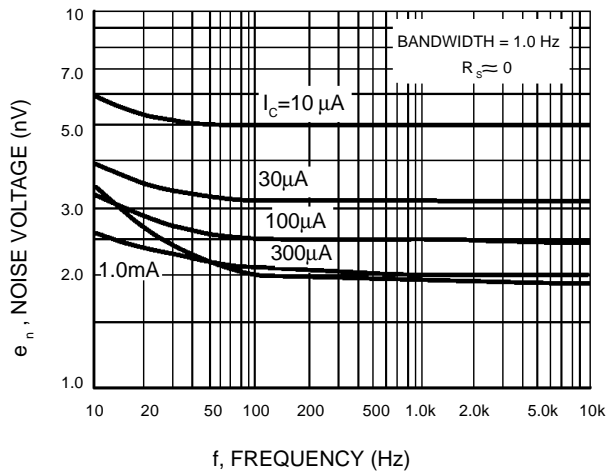
Output Capacitance ( $I_E = 0 \text{ V}$ , $V_{CB} = -10 \text{ Vdc}$ , $f = 1.0 \text{ MHz}$ )	$C_{obo}$	—	7.0	pF
Noise Figure ( $V_{CE} = -5.0 \text{ Vdc}$ , $I_C = -0.2 \text{ mAdc}$ , $R_S = 2.0 \text{ k}\Omega$ , $f = 1.0 \text{ kHz}$ , $BW = 200 \text{ Hz}$ )	$N_F$	—	10	dB

**Ordering Information**

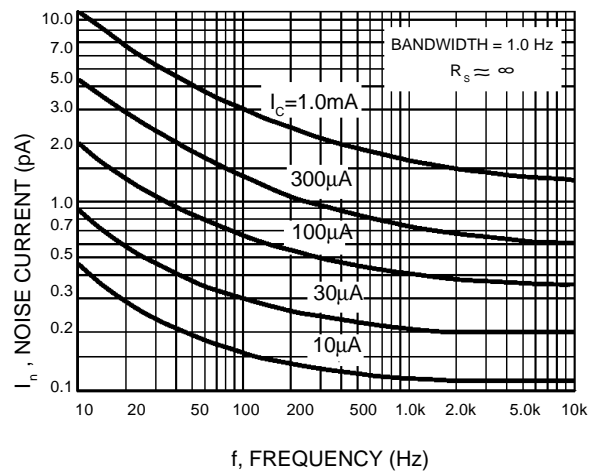
Device	Marking	Shipping
BCW69LT1	H1	3000/Tape&Reel
BCW70LT1	H2	3000/Tape&Reel

### TYPICAL NOISE CHARACTERISTICS

( $V_{CE} = -5.0 \text{ Vdc}$ ,  $T_A = 25^\circ\text{C}$ )



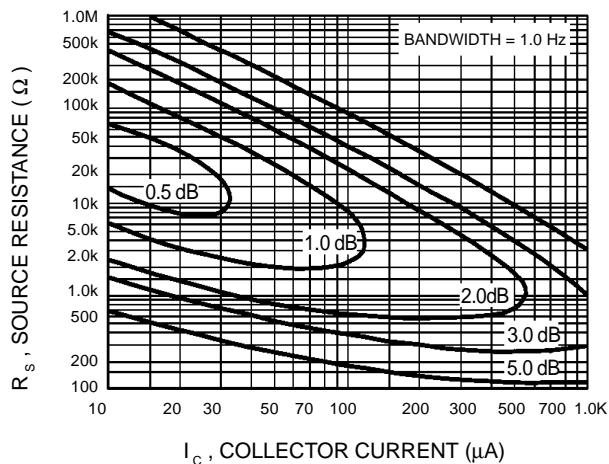
**Figure 1. Noise Voltage**



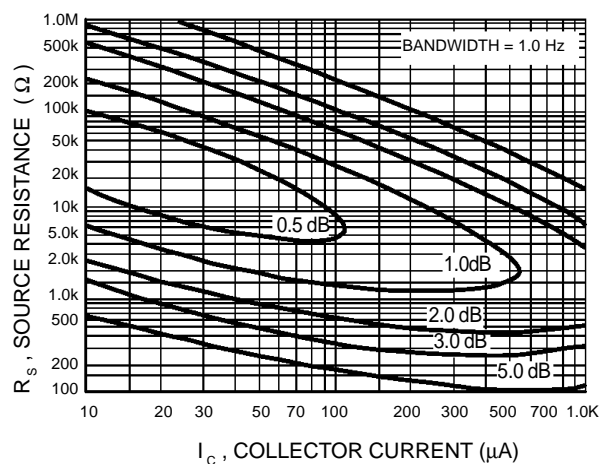
**Figure 2. Noise Current**

### NOISE FIGURE CONTOURS

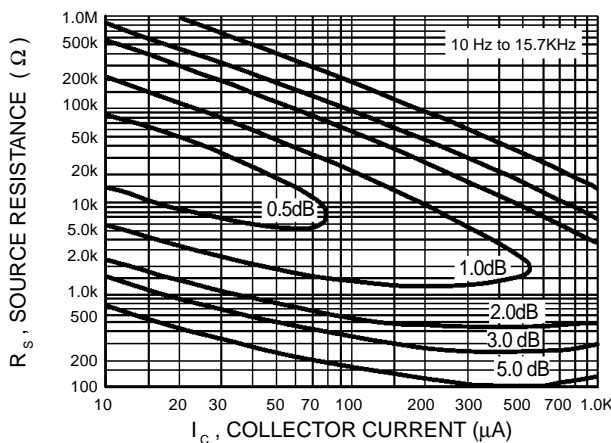
( $V_{CE} = -5.0 \text{ Vdc}$ ,  $T_A = 25^\circ\text{C}$ )



**Figure 3. Narrow Band, 100 Hz**



**Figure 4. Narrow Band, 1.0 kHz**



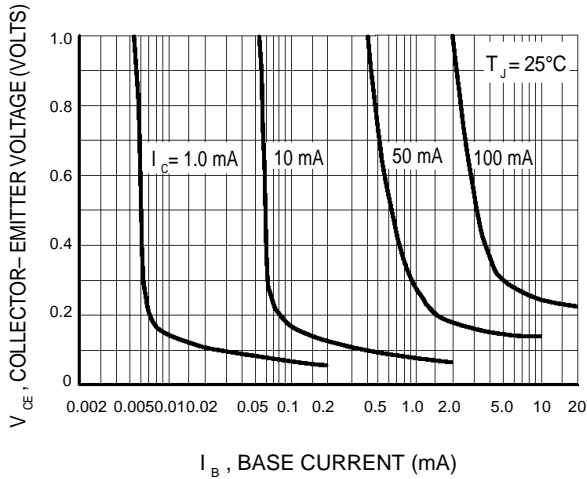
**Figure 5. Wideband**

Noise Figure is Defined as:

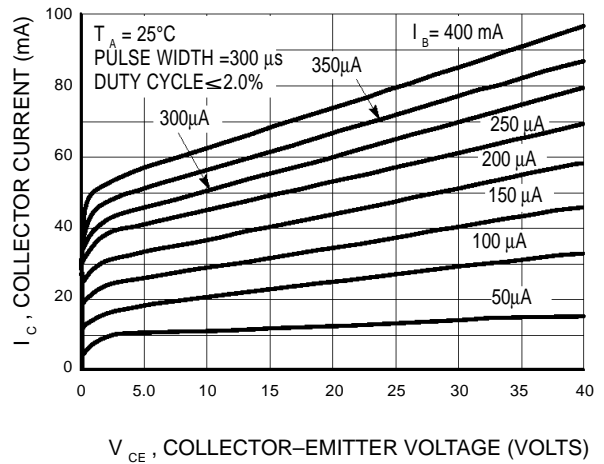
$$NF = 20 \log_{10} \left( \frac{e_n^2 + 4KTR_s + I_n^2 R_s^2}{4KTR_s} \right)^{1/2}$$

- $e_n$  = Noise Voltage of the Transistor referred to the input. (Figure 3)
- $I_n$  = Noise Current of the Transistor referred to the input. (Figure 4)
- $K$  = Boltzman's Constant ( $1.38 \times 10^{-23} \text{ J/}^\circ\text{K}$ )
- $T$  = Temperature of the Source Resistance ( $^\circ\text{K}$ )
- $R_s$  = Source Resistance ( $\Omega$ )

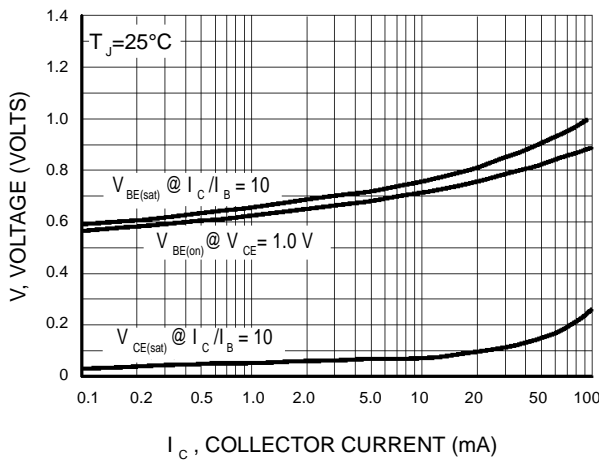
**TYPICAL STATIC CHARACTERISTICS**



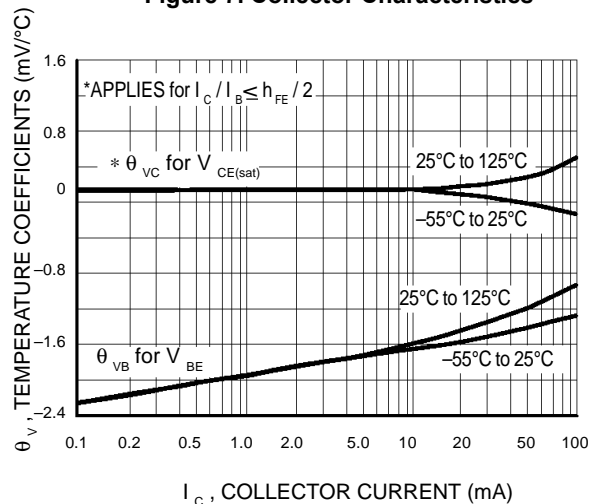
**Figure 6. Collector Saturation Region**



**Figure 7. Collector Characteristics**

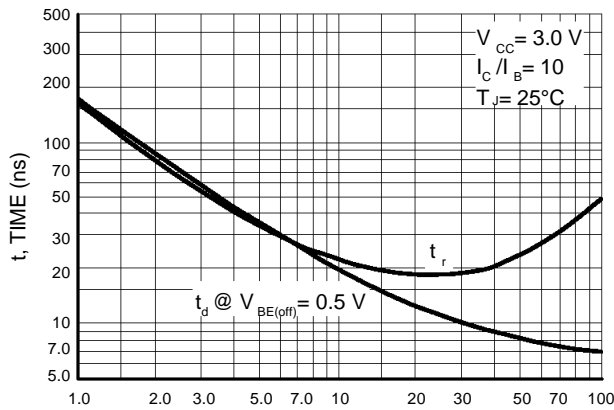


**Figure 10. "On" Voltages**



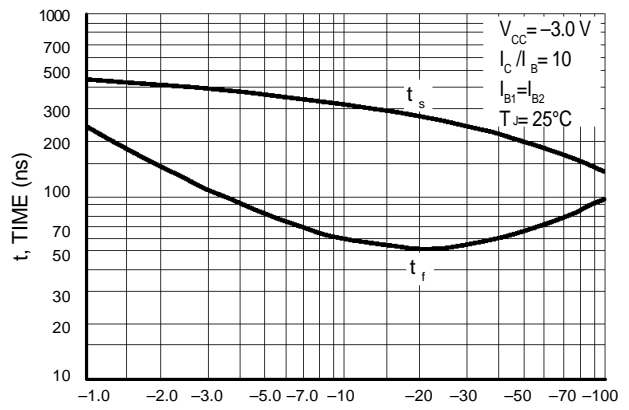
**Figure 11. Temperature Coefficients**

### TYPICAL DYNAMIC CHARACTERISTICS



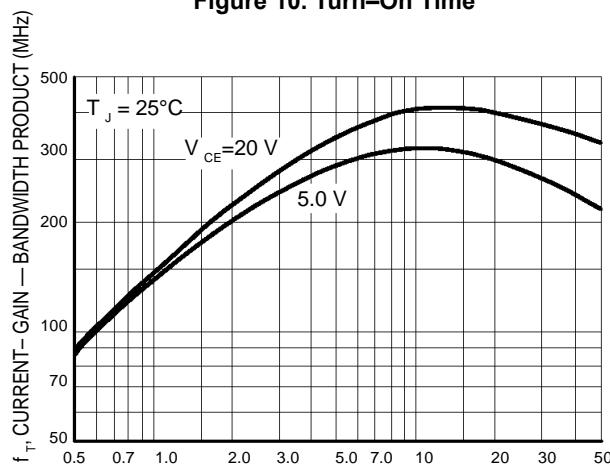
$I_C$ , COLLECTOR CURRENT (mA)

**Figure 10. Turn-On Time**



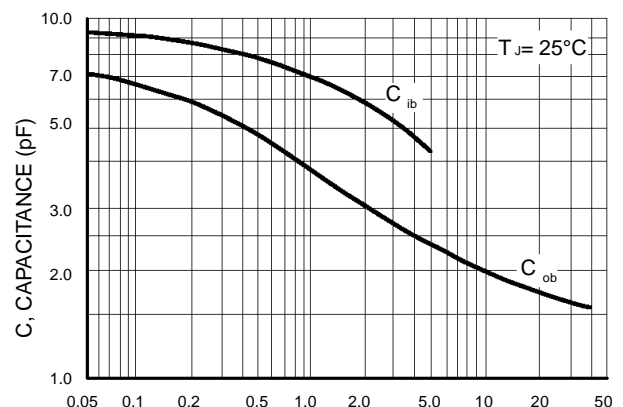
$I_C$ , COLLECTOR CURRENT (mA)

**Figure 11. Turn-Off Time**



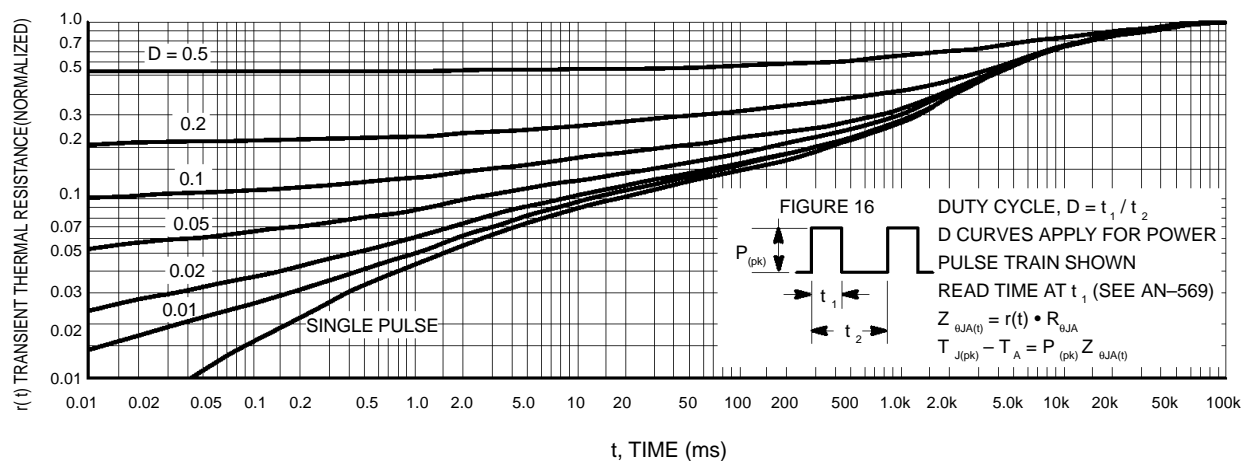
$I_C$ , COLLECTOR CURRENT (mA)

**Figure 12. Current-Gain — Bandwidth Product**



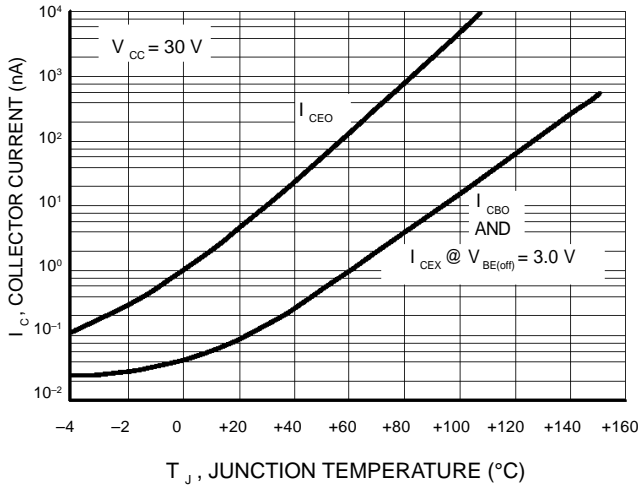
$V_R$ , REVERSE VOLTAGE (VOLTS)

**Figure 13. Capacitance**



t, TIME (ms)

**Figure 14. Thermal Response**



**Figure 15. Typical Collector Leakage Current**

**DESIGN NOTE: USE OF THERMAL RESPONSE DATA**

A train of periodical power pulses can be represented by the model as shown in Figure 16. Using the model and the device thermal response the normalized effective transient thermal resistance of Figure 14 was calculated for various duty cycles.

To find  $Z_{\theta JA(t)}$ , multiply the value obtained from Figure 14 by the steady state value  $R_{\theta JA}$ .

Example:

Dissipating 2.0 watts peak under the following conditions:

$$t_1 = 1.0 \text{ ms}, t_2 = 5.0 \text{ ms. (D = 0.2)}$$

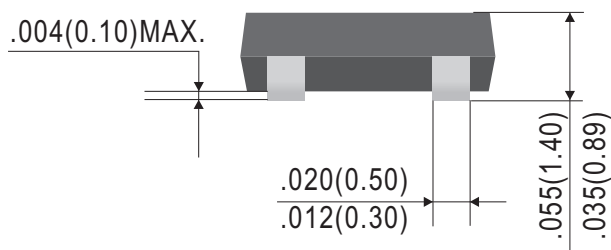
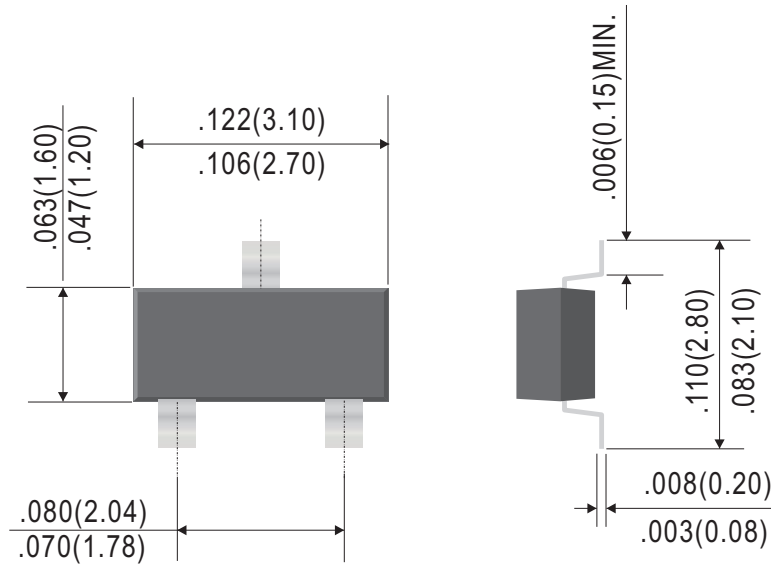
Using Figure 14 at a pulse width of 1.0 ms and  $D = 0.2$ , the reading of  $r(t)$  is 0.22.

The peak rise in junction temperature is therefore

$$\Delta T = r(t) \times P_{(pk)} \times R_{\theta JA} = 0.22 \times 2.0 \times 200 = 88^\circ\text{C}.$$

For more information, see AN-569.

**SOT-23**



Dimensions in inches and (millimeters)

