

BCR3AM

LOW POWER USE
NON-INSULATED TYPE, PLANAR PASSIVATION TYPE

BCR3AM



- I_T (RMS) **3A**
- V_{DRM} **400V/600V**
- IFGT I , IRGT I , IRGT III **30mA (15mA) *6**

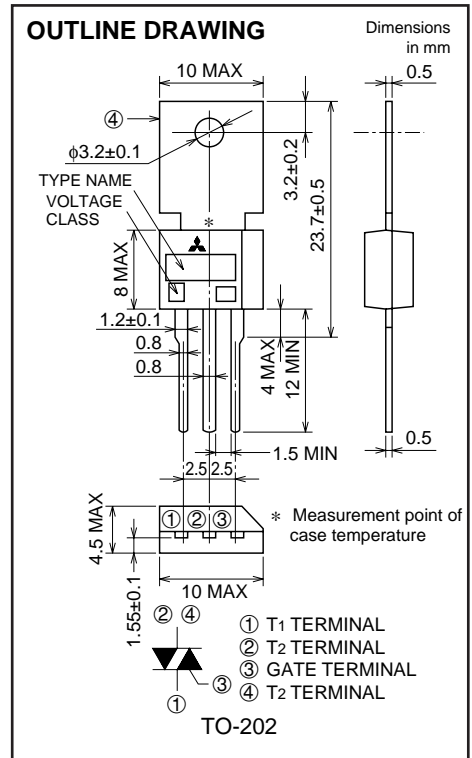

APPLICATION

Contactless AC switches, light dimmer, electric blankets, control of household equipment such as electric fan, solenoid drivers, small motor control, other general purpose control applications

MAXIMUM RATINGS

Symbol	Parameter	Voltage class		Unit
		8	12	
V_{DRM}	Repetitive peak off-state voltage *1	400	600	V
V_{DSM}	Non-repetitive peak off-state voltage *1	500	720	V

Symbol	Parameter	Conditions	Ratings	Unit
I_T (RMS)	RMS on-state current	Commercial frequency, sine full wave 360° conduction, $T_c = 86^\circ\text{C}$	3	A
I_{TSM}	Surge on-state current	60Hz sinewave 1 full cycle, peak value, non-repetitive	30	A
I_t^2	I_t^2 for fusing	Value corresponding to 1 cycle of half wave 60Hz, surge on-state current	3.7	A^2s
PGM	Peak gate power dissipation		3	W
PG (AV)	Average gate power dissipation		0.3	W
VGM	Peak gate voltage		6	V
IGM	Peak gate current		0.5	A
T_j	Junction temperature		-40 ~ +125	$^\circ\text{C}$
T_{stg}	Storage temperature		-40 ~ +125	$^\circ\text{C}$
—	Weight	Typical value	1.6	g

*1. Gate open.

BCR3AM

LOW POWER USE

NON-INSULATED TYPE, PLANAR PASSIVATION TYPE

ELECTRICAL CHARACTERISTICS

Symbol	Parameter	Test conditions	Limits			Unit	
			Min.	Typ.	Max.		
IDRM	Repetitive peak off-state current	T _j =125°C, V _{DRM} applied	—	—	2.0	mA	
VTM	On-state voltage	T _c =25°C, I _{TM} =4.5A, Instantaneous measurement	—	—	1.5	V	
VFGT I	Gate trigger voltage *2	T _j =25°C, V _D =6V, R _L =6Ω, R _G =330Ω	I	—	—	1.5	V
VRGT I			II	—	—	1.5	V
VRGT III			III	—	—	1.5	V
IFGT I	Gate trigger current *2	T _j =25°C, V _D =6V, R _L =6Ω, R _G =330Ω	I	—	—	30*6	mA
IRGT I			II	—	—	30*6	mA
IRGT III			III	—	—	30*6	mA
VGD	Gate non-trigger voltage	T _j =125°C, V _D =1/2V _{DRM}	0.2	—	—	V	
Rth (j-c)	Thermal resistance	Junction to case *4 *5	—	—	10	°C/W	
(dv/dt) _c	Critical-rate of rise of off-state commutating voltage		*3	—	—	V/μs	

- *2. Measurement using the gate trigger characteristics measurement circuit.
- *3. The critical-rate of rise of the off-state commutating voltage is shown in the table below.
- *4. Case temperature is measured at the T₂ terminal 1.5mm away from the molded case.
- *5. The contact thermal resistance R_{th (c-f)} in case of greasing is 3°C/W.
- *6. High sensitivity (I_{GT}≤15mA) is also available. (IGT item ①)

Voltage class	V _{DRM} (V)	(dv/dt) _c		Test conditions	Commutating voltage and current waveforms (inductive load)
		Min.	Unit		
8	400	5	V/μs	1. Junction temperature T _j =125°C 2. Rate of decay of on-state commutating current (di/dt) _c =-1.5A/ms 3. Peak off-state voltage V _D =400V	
12	600				

PERFORMANCE CURVES

MAXIMUM ON-STATE CHARACTERISTICS

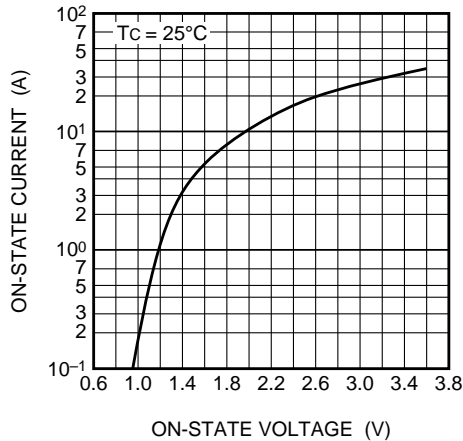

RATED SURGE ON-STATE CURRENT

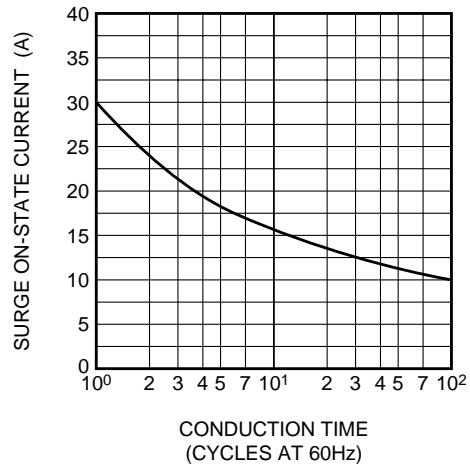

BCR3AM

LOW POWER USE
NON-INSULATED TYPE, PLANAR PASSIVATION TYPE

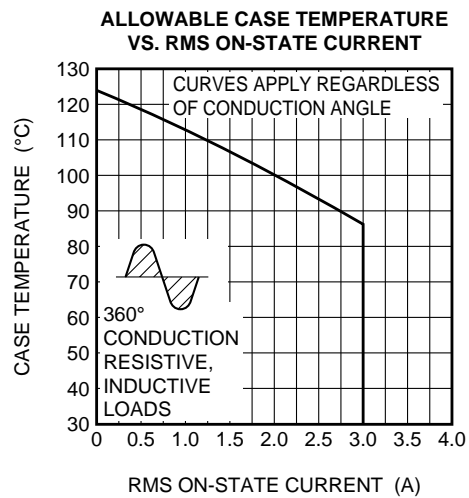
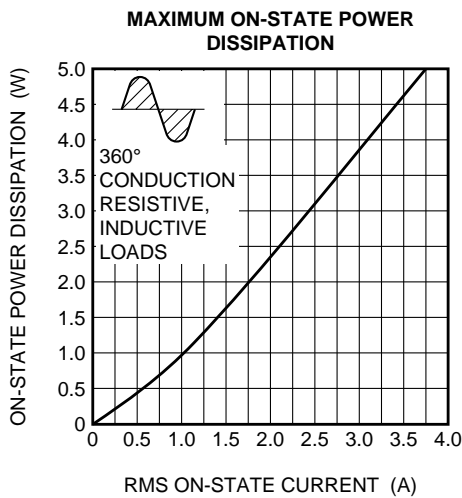
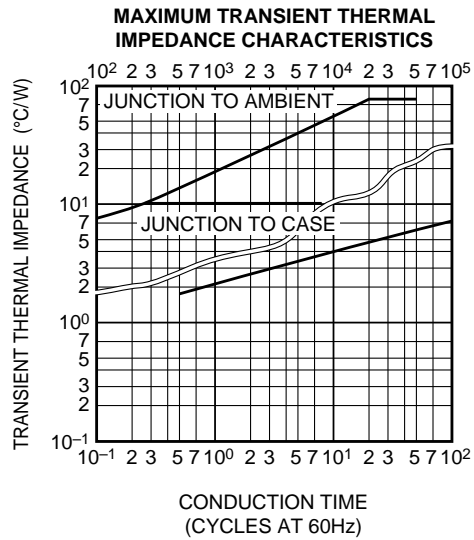
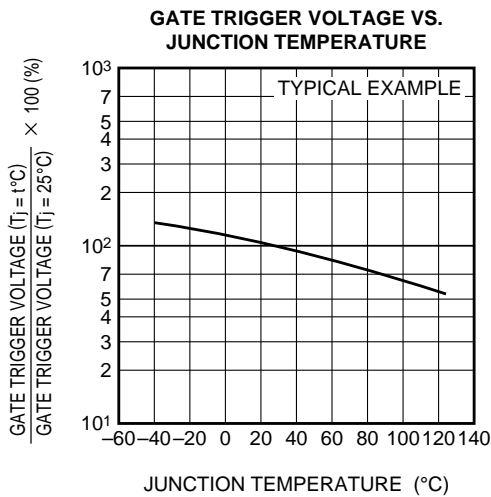
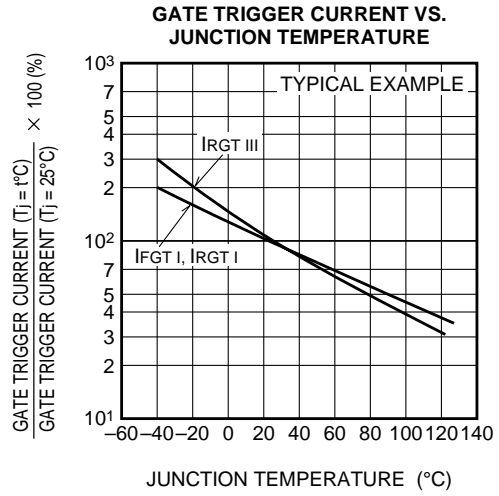
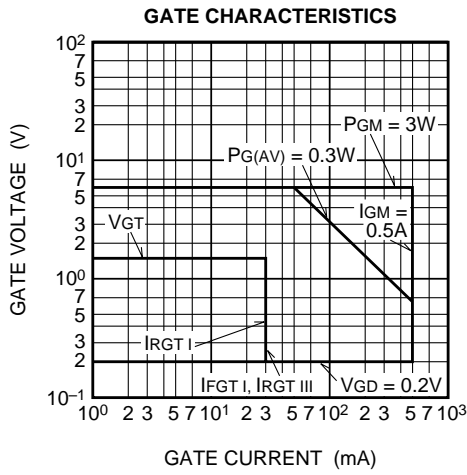

BCR3AM

LOW POWER USE
NON-INSULATED TYPE, PLANAR PASSIVATION TYPE

ALLOWABLE AMBIENT TEMPERATURE VS. RMS ON-STATE CURRENT

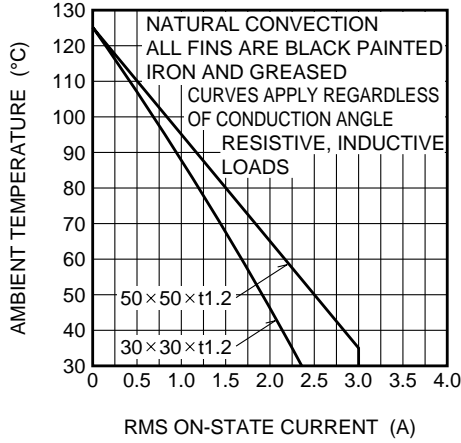

ALLOWABLE AMBIENT TEMPERATURE VS. RMS ON-STATE CURRENT

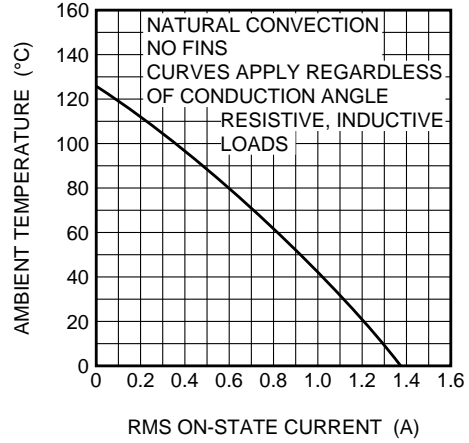

REPETITIVE PEAK OFF-STATE CURRENT VS. JUNCTION TEMPERATURE

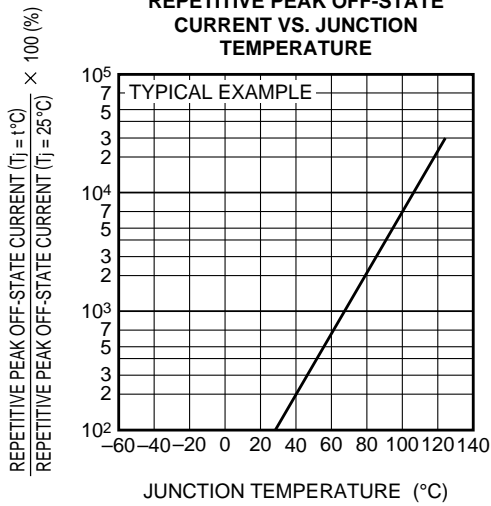

HOLDING CURRENT VS. JUNCTION TEMPERATURE

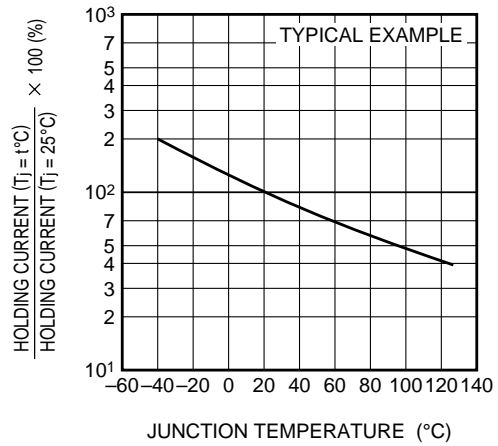

LATCHING CURRENT VS. JUNCTION TEMPERATURE

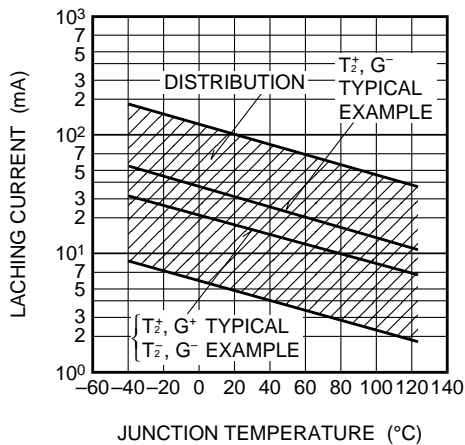

BREAKOVER VOLTAGE VS. JUNCTION TEMPERATURE

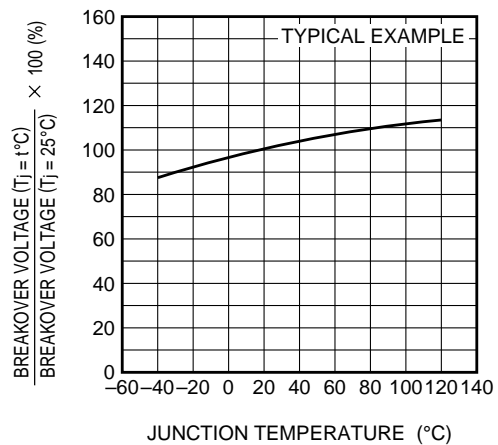

BCR3AM

LOW POWER USE
NON-INSULATED TYPE, PLANAR PASSIVATION TYPE

BREAKOVER VOLTAGE VS. RATE OF RISE OF OFF-STATE VOLTAGE

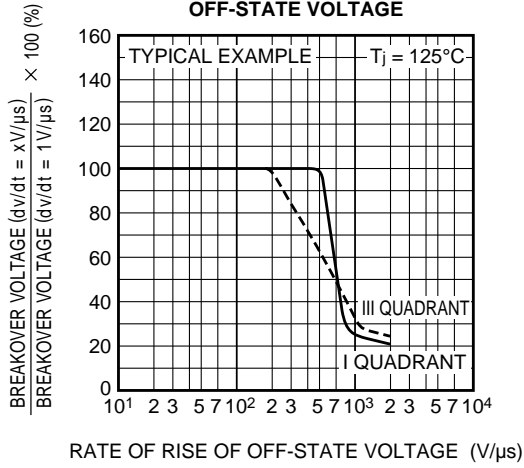

COMMUTATION CHARACTERISTICS

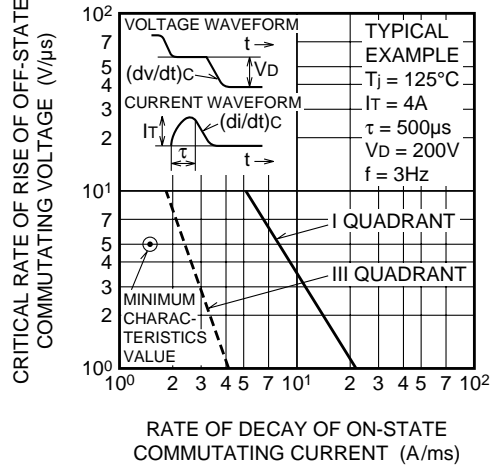

GATE TRIGGER CURRENT VS. GATE CURRENT PULSE WIDTH

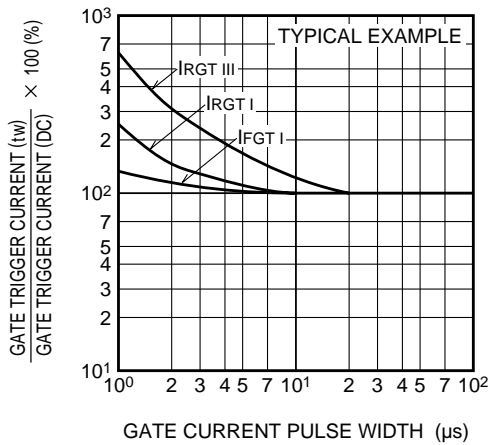

GATE TRIGGER CHARACTERISTICS TEST CIRCUITS

