

BCR30AM

MEDIUM POWER USE
NON-INSULATED TYPE, PLANAR PASSIVATION TYPE

BCR30AM

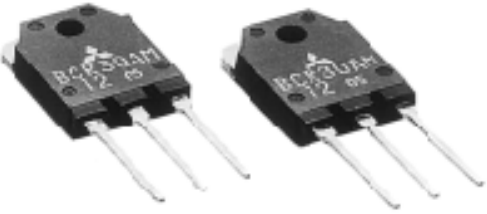

- I_T (RMS) 30A
- V_{DRM} 400V/600V
- $I_{FGT I}$, $I_{RG T I}$, $I_{RG T II}$ 50mA

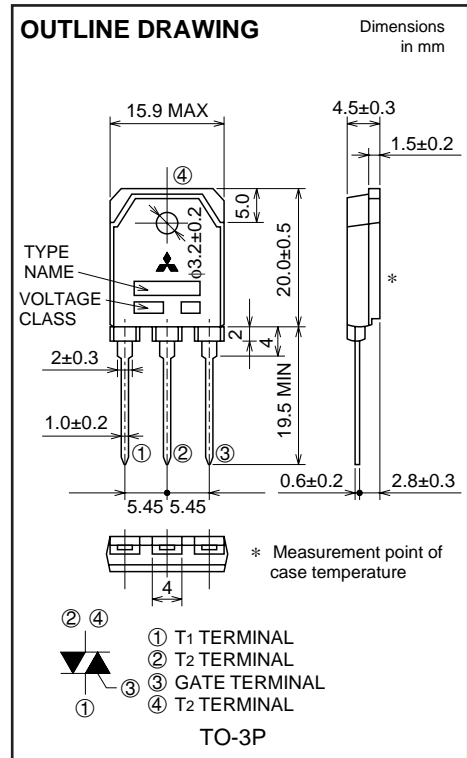

APPLICATION

Contactless AC switches, light dimmer,
on/off and speed control of small induction motors, on/off control of copier lamps,
microwave ovens

MAXIMUM RATINGS

Symbol	Parameter	Voltage class		Unit
		8	12	
V_{DRM}	Repetitive peak off-state voltage*1	400	600	V
V_{DSM}	Non-repetitive peak off-state voltage*1	500	720	V

Symbol	Parameter	Conditions	Ratings	Unit
I_T (RMS)	RMS on-state current	Commercial frequency, sine full wave 360° conduction, $T_c=75^\circ\text{C}$	30	A
I_{TSM}	Surge on-state current	60Hz sinewave 1 full cycle, peak value, non-repetitive	300	A
I^2t	I^2t for fusing	Value corresponding to 1 cycle of half wave 60Hz, surge on-state current	378	A^2s
PGM	Peak gate power dissipation		5	W
PG (AV)	Average gate power dissipation		0.5	W
VGM	Peak gate voltage		10	V
IGM	Peak gate current		2	A
T_j	Junction temperature		-40 ~ +125	$^\circ\text{C}$
T_{stg}	Storage temperature		-40 ~ +125	$^\circ\text{C}$
—	Weight	Typical value	4.8	g

*1. Gate open.

BCR30AM

MEDIUM POWER USE

NON-INSULATED TYPE, PLANAR PASSIVATION TYPE

ELECTRICAL CHARACTERISTICS

Symbol	Parameter	Test conditions	Limits			Unit	
			Min.	Typ.	Max.		
IDRM	Repetitive peak off-state current	T _j =125°C, V _{DRM} applied	—	—	3.0	mA	
VTM	On-state voltage	T _c =25°C, I _{TM} =45A, Instantaneous measurement	—	—	1.6	V	
VFGT I	Gate trigger voltage *2	T _j =25°C, V _D =6V, R _L =6Ω, R _G =330Ω	I	—	—	2.5	V
VRGT I			II	—	—	2.5	V
VRGT III			III	—	—	2.5	V
IFGT I	Gate trigger current *2	T _j =25°C, V _D =6V, R _L =6Ω, R _G =330Ω	I	—	—	50	mA
IRGT I			II	—	—	50	mA
IRGT III			III	—	—	50	mA
VGD	Gate non-trigger voltage	T _j =125°C, V _D =1/2V _{DRM}	0.2	—	—	V	
R _{th(j-c)}	Thermal resistance	Junction to case *4	—	—	1.2	°C/W	
(dv/dt) _c	Critical-rate of rise of off-state commutating voltage		*3	—	—	V/μs	

*2. Measurement using the gate trigger characteristics measurement circuit.

*3. The critical-rate of rise of the off-state commutating voltage is shown in the table below.

*4. The contact thermal resistance R_{th(b-f)} in case of greasing is 0.3°C/W.

Voltage class	V _{DRM} (V)	(dv/dt) _c			Test conditions	Commutating voltage and current waveforms (inductive load)
		Symbol	Min.	Unit		
8	400	R	—	V/μs	1. Junction temperature T _j =125°C 2. Rate of decay of on-state commutating current (di/dt) _c =-16A/ms 3. Peak off-state voltage V _D =400V	
		L	20			
12	600	R	—			
		L	20			

PERFORMANCE CURVES

MAXIMUM ON-STATE CHARACTERISTICS

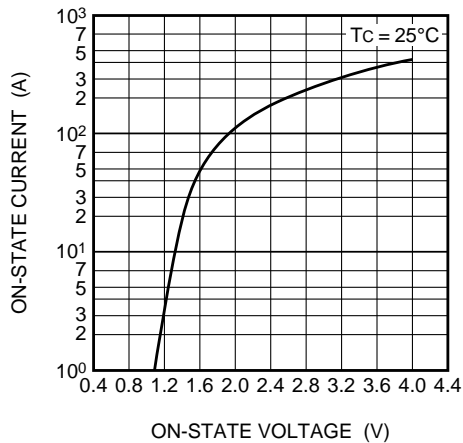

RATED SURGE ON-STATE CURRENT

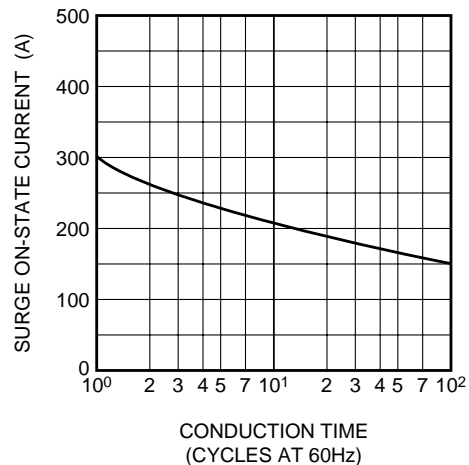

BCR30AM

MEDIUM POWER USE

NON-INSULATED TYPE, PLANAR PASSIVATION TYPE

GATE CHARACTERISTICS

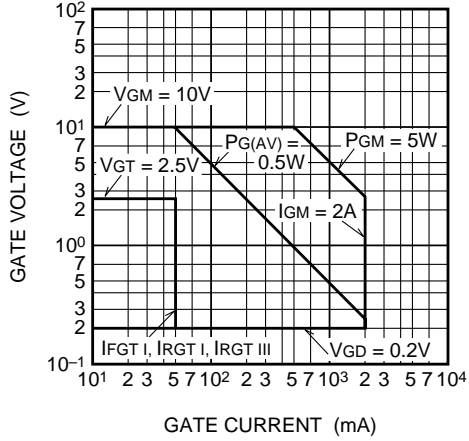

GATE TRIGGER CURRENT VS. JUNCTION TEMPERATURE

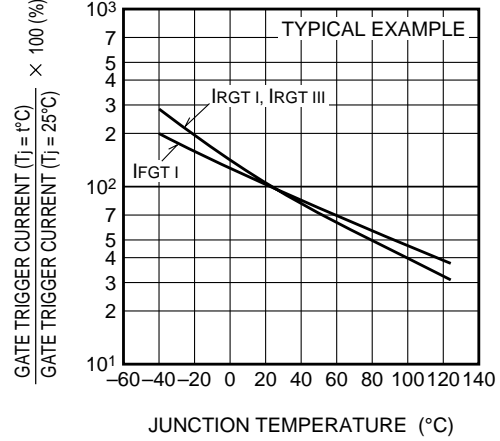

GATE TRIGGER VOLTAGE VS. JUNCTION TEMPERATURE

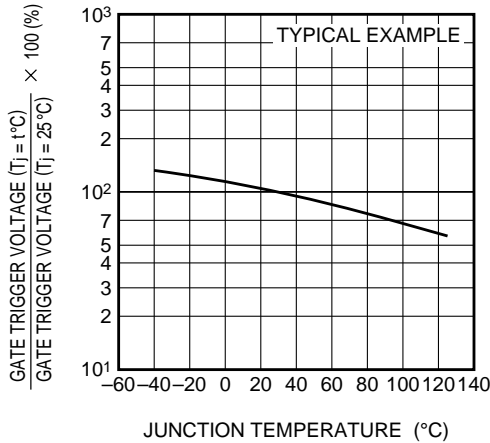

MAXIMUM TRANSIENT THERMAL IMPEDANCE CHARACTERISTICS (JUNCTION TO CASE)

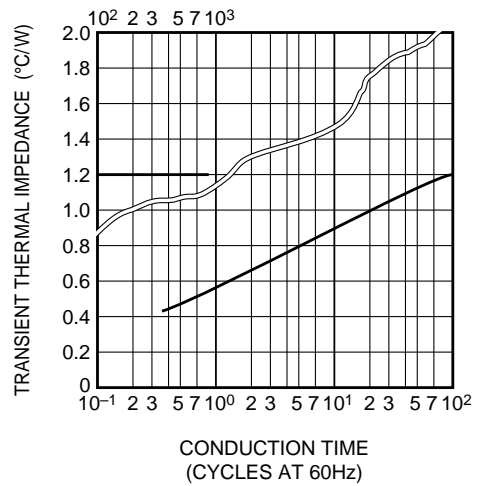

MAXIMUM ON-STATE POWER DISSIPATION

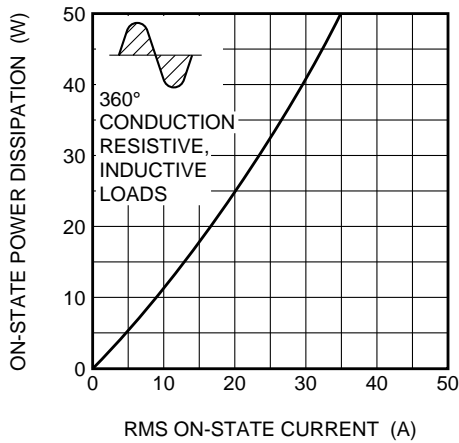

ALLOWABLE CASE TEMPERATURE VS. RMS ON-STATE CURRENT

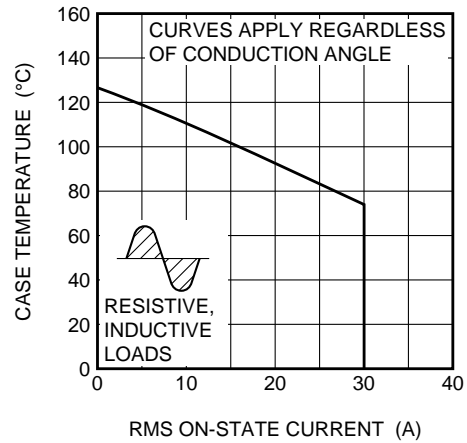

BCR30AM

MEDIUM POWER USE

NON-INSULATED TYPE, PLANAR PASSIVATION TYPE

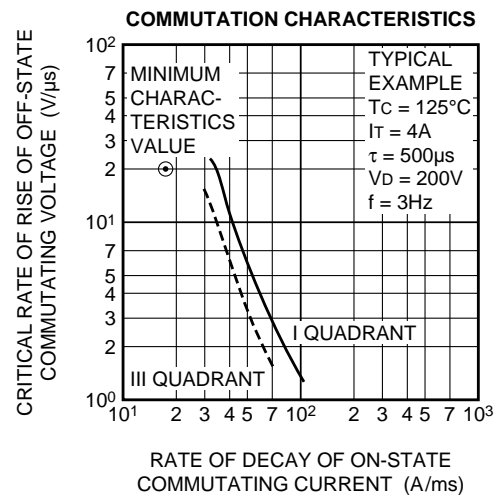
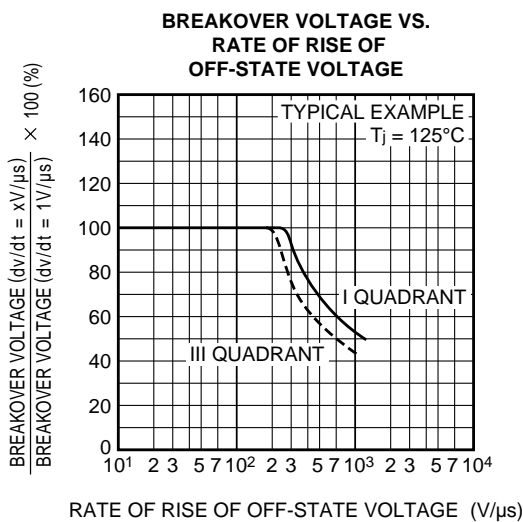
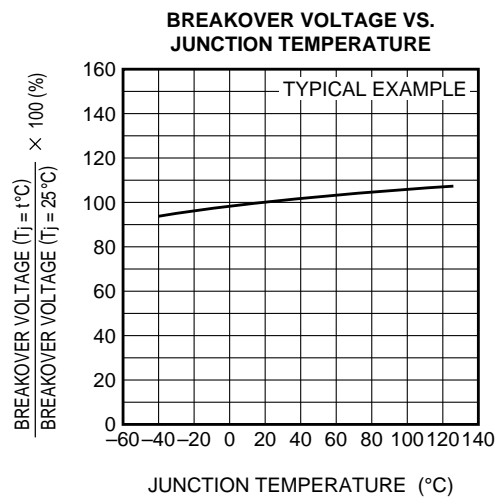
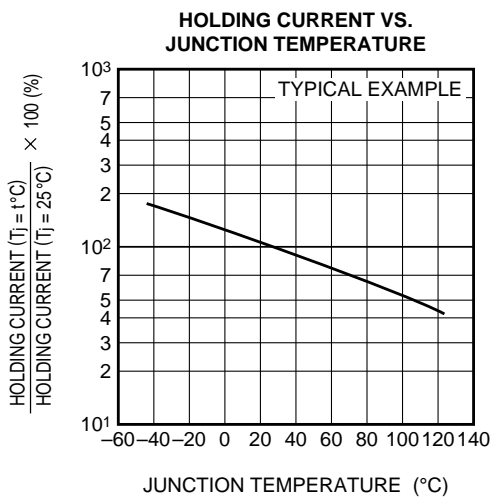
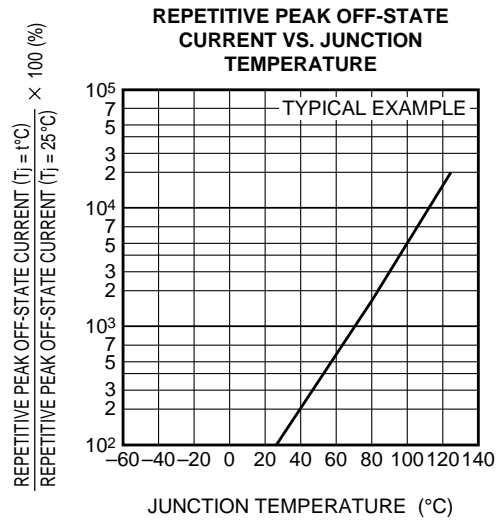
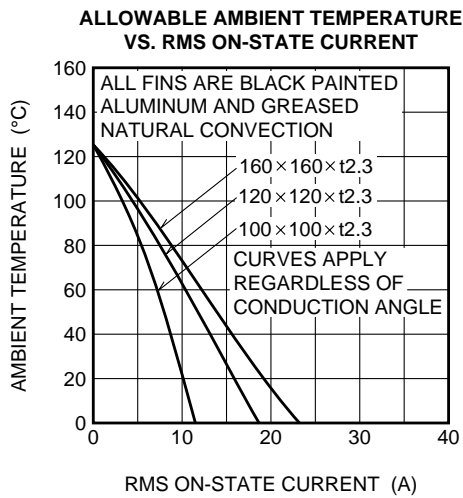

BCR30AM

MEDIUM POWER USE
NON-INSULATED TYPE, PLANAR PASSIVATION TYPE

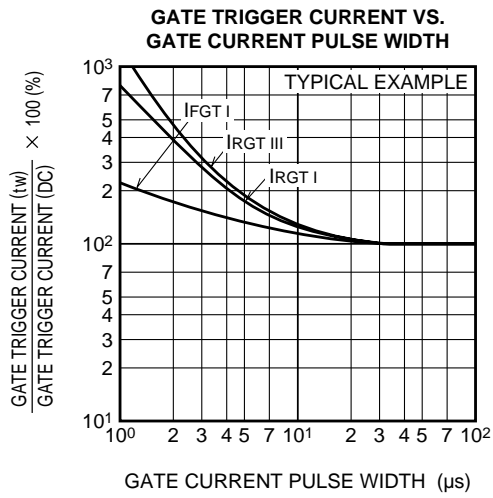

GATE TRIGGER CHARACTERISTICS TEST CIRCUITS

