



Micro Commercial Components



Micro Commercial Components  
 20736 Marilla Street Chatsworth  
 CA 91311  
 Phone: (818) 701-4933  
 Fax: (818) 701-4939

# BAT54T THRU BAT54ST

## Features

- Ultra-Small Surface Mount Package
- Low Forward Voltage Drop
- Halogen free available upon request by adding suffix "-HF"
- PN Junction Guard Ring for Transient and ESD Protection
- Epoxy meets UL 94 V-0 flammability rating
- Moisture Sensitivity Level 1
- Lead Free Finish/Rohs Compliant ("P" Suffix designates RoHS Compliant. See ordering information)

MCC Part Number	Device Marking	Type	Pin Configuration
BAT54T	L1	Single	Figure 1
BAT54AT	L2	Dual	Figure 2
BAT54CT	L3	Dual	Figure 3
BAT54ST	L4	Dual	Figure 4

## Maximum Ratings

DC Blocking Voltage	$V_R$	30V
Average Rectified Output Current	$I_O$	200mA
Repetitive Peak Forward Current	$I_{FRM}$	300mA
Non-Repetitive Peak Forward Current $t < 1s$	$I_{FSM}$	600mA
Total Power Dissipation @ $T_A = 25^\circ C$	$P_D$	150mW
Storage Temperature Range	$T_{stg}$	$-65^\circ C$ to $125^\circ C$
Junction Temperature	$T_j$	$-65^\circ C$ to $125^\circ C$
Thermal Resistance Junction to Ambient	$R_{\theta JA}$	667°C/W

## Electrical Characteristics @ 25°C Unless Otherwise Specified

Ratings	Symbol	Max.	Notes
Forward Voltage	$V_F$	240mV 320mV 400mV 500mV 1000mV	$I_F = 0.1mA$ $I_F = 1mA$ $I_F = 10mA$ $I_F = 30mA$ $I_F = 100mA$
Reverse Current	$I_R$	2μA	$V_R = 25V$
Reverse Breakdown Voltage	$V_{(BR)}$	>30V	$I_R = 100uA$
Total Capacitance	$C_T$	10pF	Measured at 1.0MHz, $V_R = 1.0V$
Reverse Recovery Time	$t_{rr}$	5nS	$I_F = 10mA$ ; $I_R = 10mA \sim 1.0mA$ , $R_L = 100 \Omega$

## 150mWatt, 30Volt Schottky Barrier Diode

### SOT-523

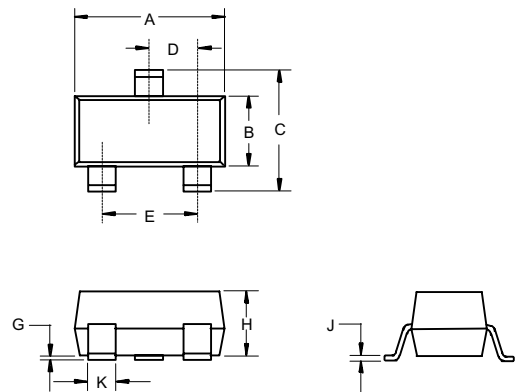

DIM	DIMENSIONS				NOTE
	INCHES		MM		
A	.059	.067	1.50	1.70	
B	.030	.033	0.75	0.85	
C	.057	.069	1.45	1.75	
D	.020 Nominal		0.50 Nominal		
E	.035	.043	0.90	1.10	
G	.000	.004	.000	.100	
H	.028	.031	.70	0.80	
J	.004	.008	.100	.200	
K	.006	.014	.15	.35	

BAT54T thru BAT54ST

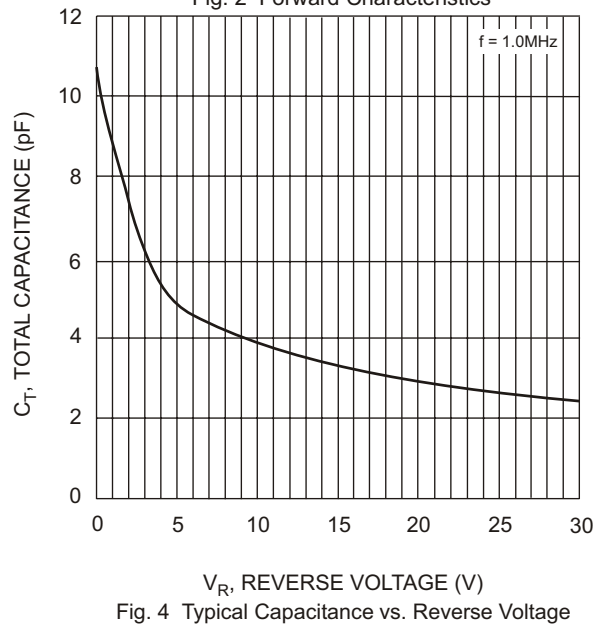
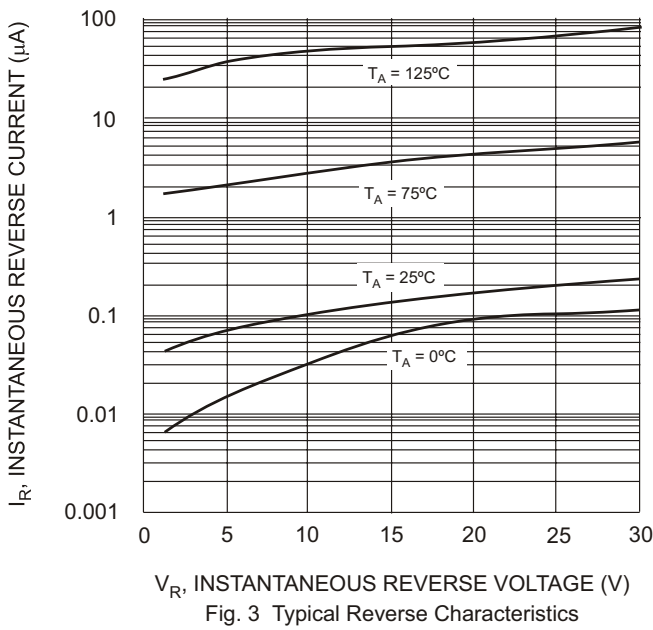
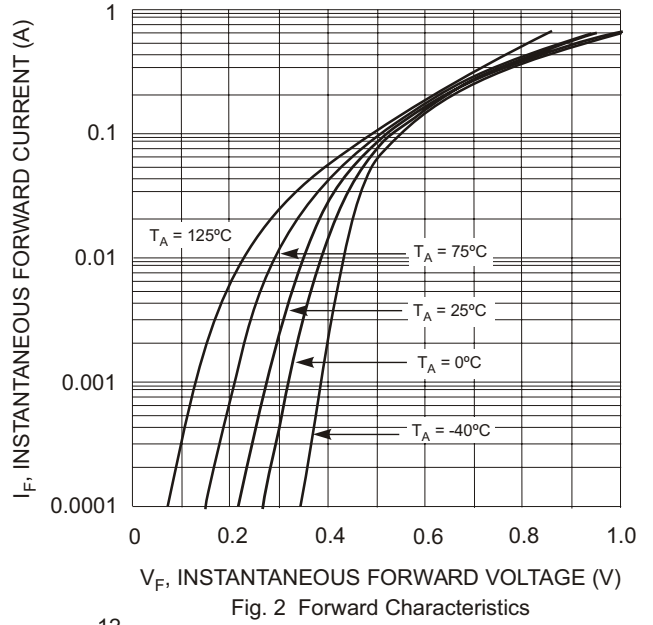
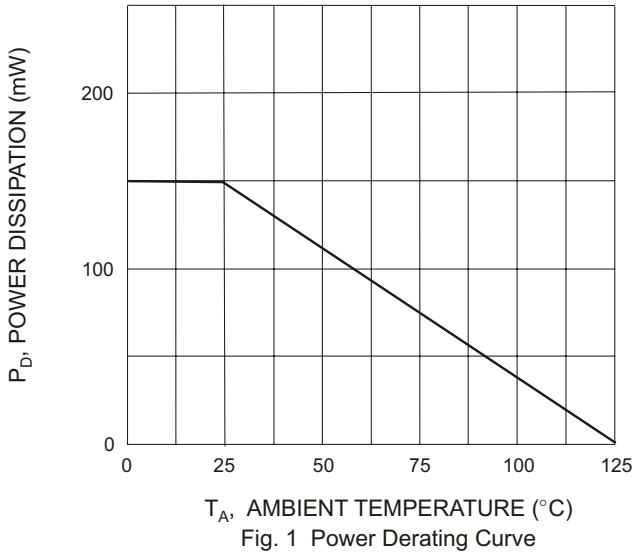

Pin Configuration - Top View

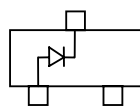

Figure 1

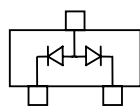

Figure 2

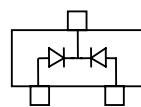

Figure 3

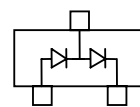

Figure 4



TM

Micro Commercial Components

## Ordering Information :

Device	Packing
Part Number-TP	Tape&Reel: 3Kpcs/Reel

Note : Adding "-HF" suffix for halogen free, eg. Part Number-TP-HF

### \*\*\*IMPORTANT NOTICE\*\*\*

**Micro Commercial Components Corp.** reserves the right to make changes without further notice to any product herein to make corrections, modifications , enhancements , improvements , or other changes . **Micro Commercial Components Corp .** does not assume any liability arising out of the application or use of any product described herein; neither does it convey any license under its patent rights ,nor the rights of others . The user of products in such applications shall assume all risks of such use and will agree to hold **Micro Commercial Components Corp .** and all the companies whose products are represented on our website, harmless against all damages.

### \*\*\*LIFE SUPPORT\*\*\*

MCC's products are not authorized for use as critical components in life support devices or systems without the express written approval of Micro Commercial Components Corporation.

### \*\*\*CUSTOMER AWARENESS\*\*\*

Counterfeiting of semiconductor parts is a growing problem in the industry. Micro Commercial Components (MCC) is taking strong measures to protect ourselves and our customers from the proliferation of counterfeit parts. MCC strongly encourages customers to purchase MCC parts either directly from MCC or from Authorized MCC Distributors who are listed by country on our web page cited below. Products customers buy either from MCC directly or from Authorized MCC Distributors are genuine parts, have full traceability, meet MCC's quality standards for handling and storage. **MCC will not provide any warranty coverage or other assistance for parts bought from Unauthorized Sources.** MCC is committed to combat this global problem and encourage our customers to do their part in stopping this practice by buying direct or from authorized distributors.

[www.mccsemi.com](http://www.mccsemi.com)