

DATA SHEET

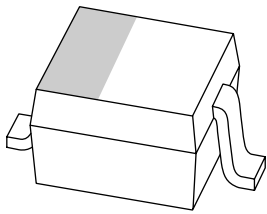

BAS321 General purpose diode

Product data sheet
Supersedes data of 1999 Feb 09

2004 Jan 26

General purpose diode

BAS321

FEATURES

- Small plastic SMD package
- Switching speed: max. 50 ns
- General application
- Continuous reverse voltage: max. 200 V
- Repetitive peak reverse voltage: max. 250 V
- Repetitive peak forward current: max. 625 mA.

APPLICATIONS

- General purpose switching in e.g. surface mounted circuits.

DESCRIPTION

The BAS321 is a general purpose diode fabricated in planar technology and encapsulated in a plastic SOD323 package.

PINNING

| PIN | DESCRIPTION |
|-----|-------------|
| 1 | cathode |
| 2 | anode |

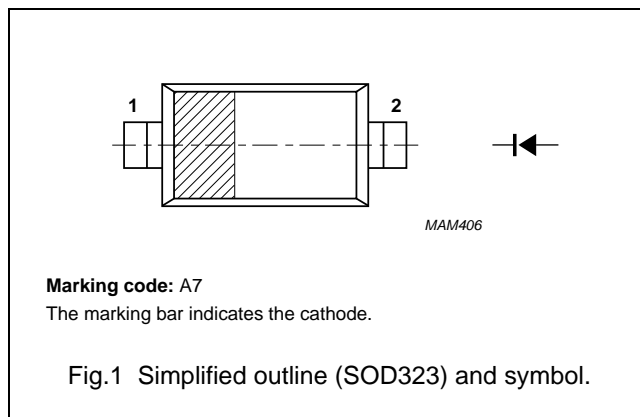

ORDERING INFORMATION

| TYPE NUMBER | PACKAGE | | |
|-------------|---------|--|---------|
| | NAME | DESCRIPTION | VERSION |
| BAS321 | - | plastic surface mounted package; 2 leads | SOD323 |

LIMITING VALUES

In accordance with the Absolute Maximum Rating System (IEC 60134).

| SYMBOL | PARAMETER | CONDITIONS | MIN. | MAX. | UNIT |
|-----------|-------------------------------------|--|------|------|------|
| V_{RRM} | repetitive peak reverse voltage | | - | 250 | V |
| V_R | continuous reverse voltage | | - | 200 | V |
| I_F | continuous forward current | see Fig.2; note 1 | - | 250 | mA |
| I_{FRM} | repetitive peak forward current | $t_p < 0.5$ ms; $\delta \leq 0.25$ | - | 625 | mA |
| I_{FSM} | non-repetitive peak forward current | square wave; $T_j = 25$ °C prior to surge; see Fig.4 | | | |
| | | $t = 1$ μ s | - | 9 | A |
| | | $t = 100$ μ s | - | 3 | A |
| | | $t = 10$ ms | - | 1.7 | A |
| P_{tot} | total power dissipation | $T_{amb} = 25$ °C; note 1 | - | 300 | mW |
| T_{stg} | storage temperature | | -65 | +150 | °C |
| T_j | junction temperature | | - | 150 | °C |

Note

1. Device mounted on an FR4 printed circuit-board.

General purpose diode

BAS321

CHARACTERISTICS $T_j = 25\text{ °C}$ unless otherwise specified.

| SYMBOL | PARAMETER | CONDITIONS | MAX. | UNIT |
|----------|-----------------------|--|------------|---------------------|
| V_F | forward voltage | see Fig.3 $I_F = 100\text{ mA}$ $I_F = 200\text{ mA}$ | 1 1.25 | V V |
| I_R | reverse current | see Fig.5 $V_R = 200\text{ V}$ $V_R = 200\text{ V}; T_j = 150\text{ °C}$ | 100 100 | nA μA |
| C_d | diode capacitance | $f = 1\text{ MHz}; V_R = 0$; see Fig.6 | 2 | pF |
| t_{rr} | reverse recovery time | when switched from $I_F = 30\text{ mA}$ to $I_R = 30\text{ mA}; R_L = 100\ \Omega$; measured at $I_R = 3\text{ mA}$; see Fig.8 | 50 | ns |

THERMAL CHARACTERISTICS

| SYMBOL | PARAMETER | CONDITIONS | VALUE | UNIT |
|---------------|---|-------------------------------|-------|------|
| $R_{th(j-s)}$ | thermal resistance from junction to soldering point | $T_s = 90\text{ °C}$; note 1 | 130 | K/W |
| $R_{th(j-a)}$ | thermal resistance from junction to ambient | note 2 | 366 | K/W |

Notes

1. Soldering point of cathode tab.
2. Device mounted on an FR4 printed circuit board.

General purpose diode

BAS321

GRAPHICAL DATA

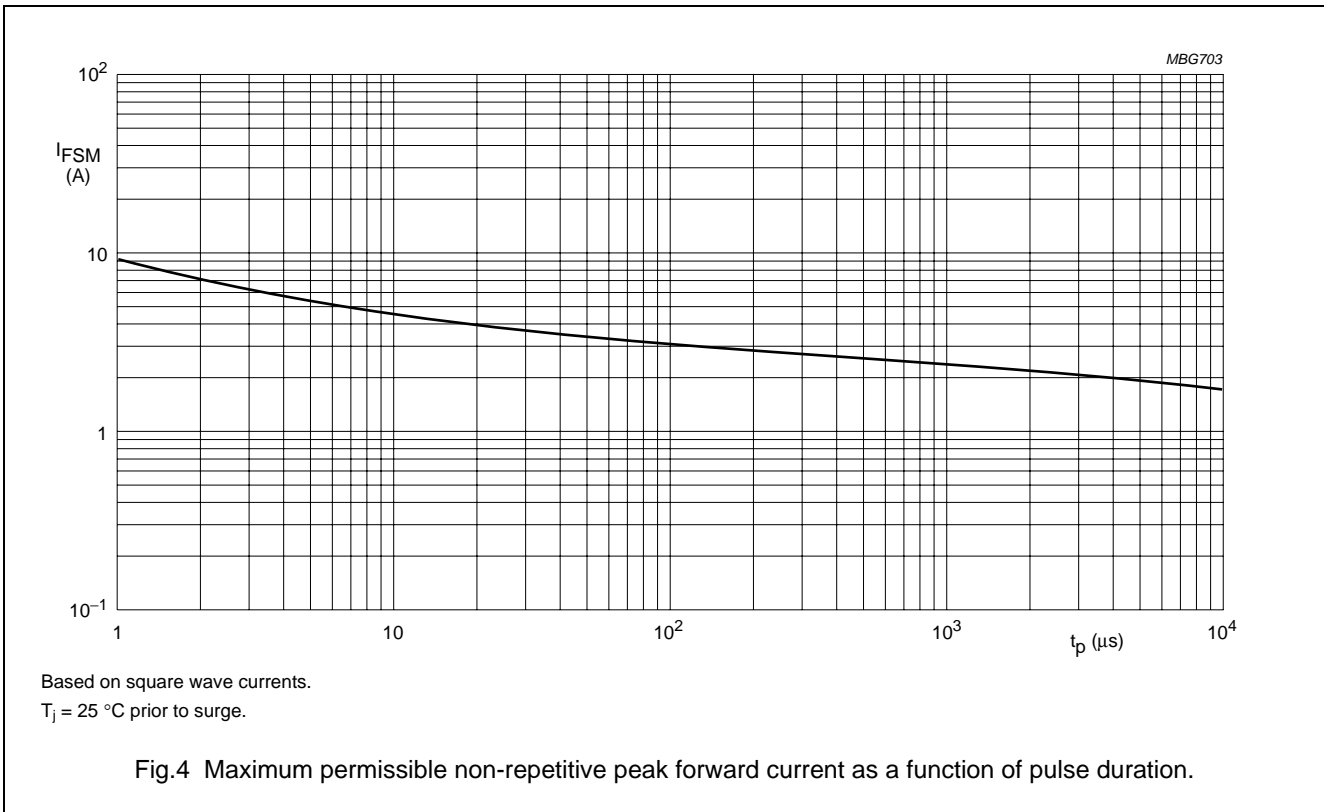
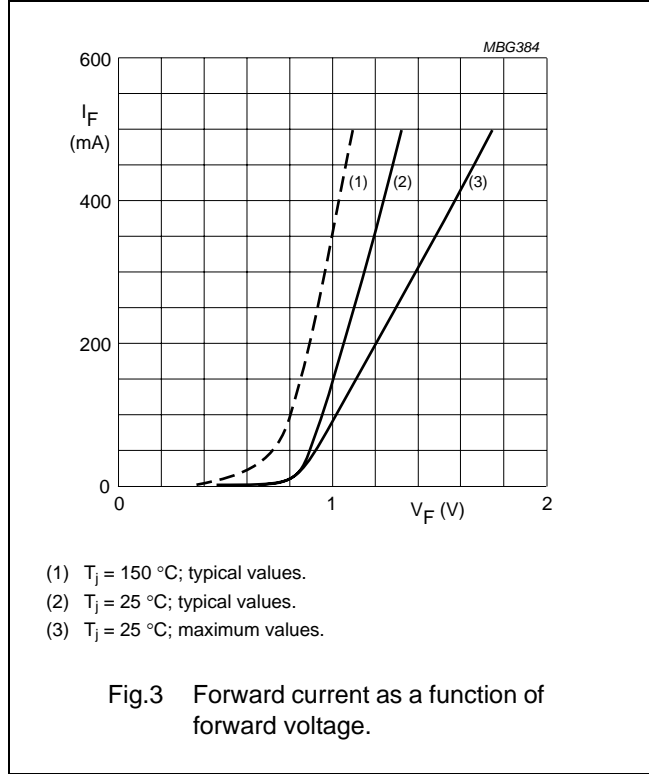
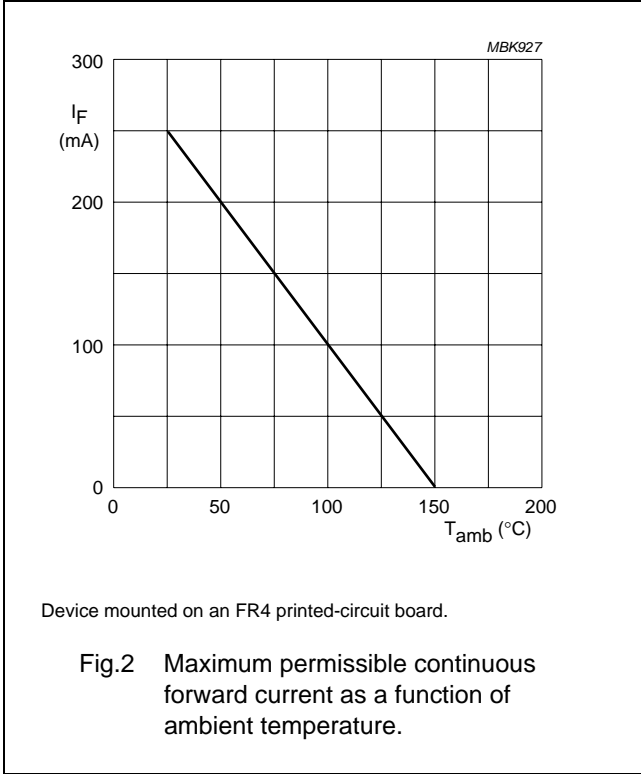

General purpose diode

BAS321

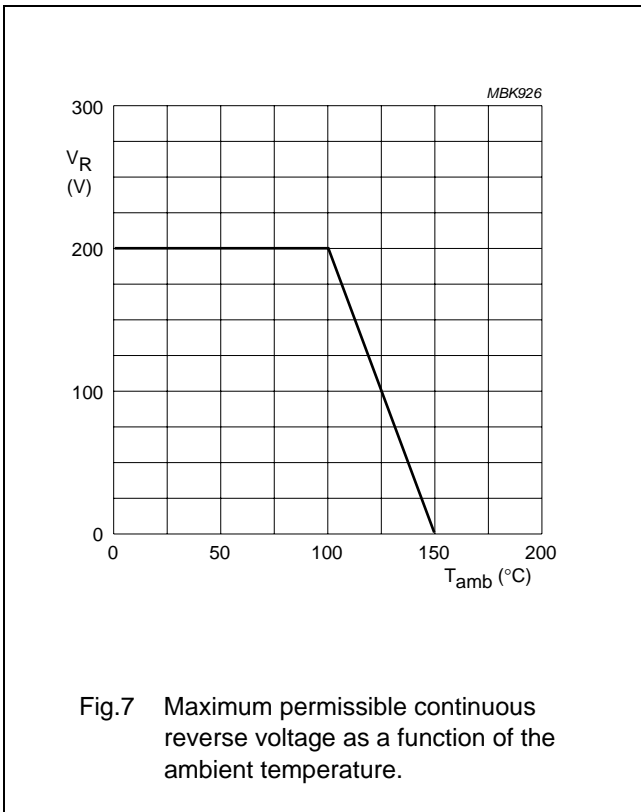
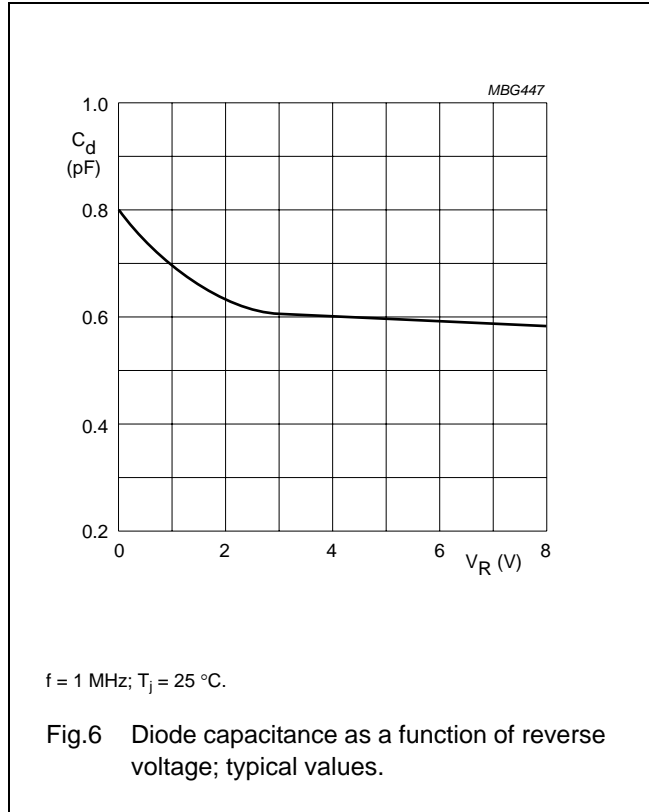
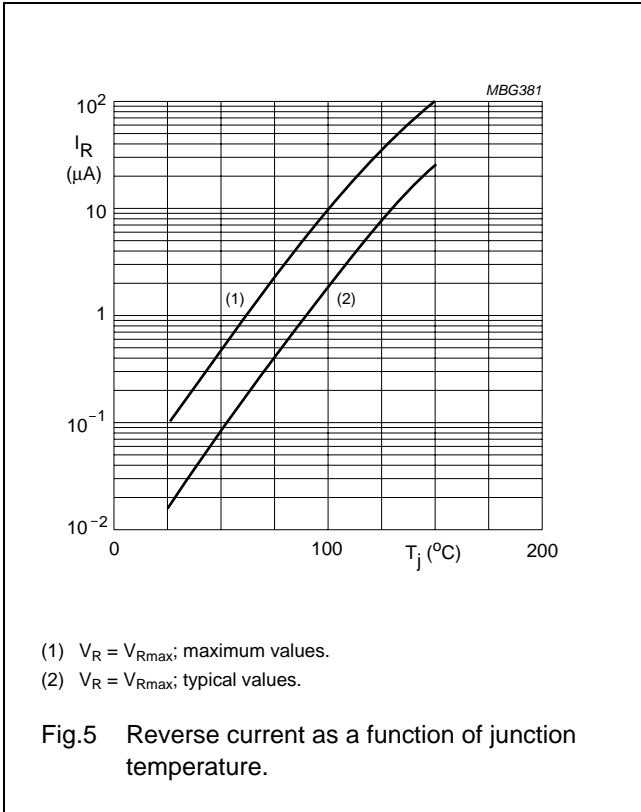

General purpose diode

BAS321

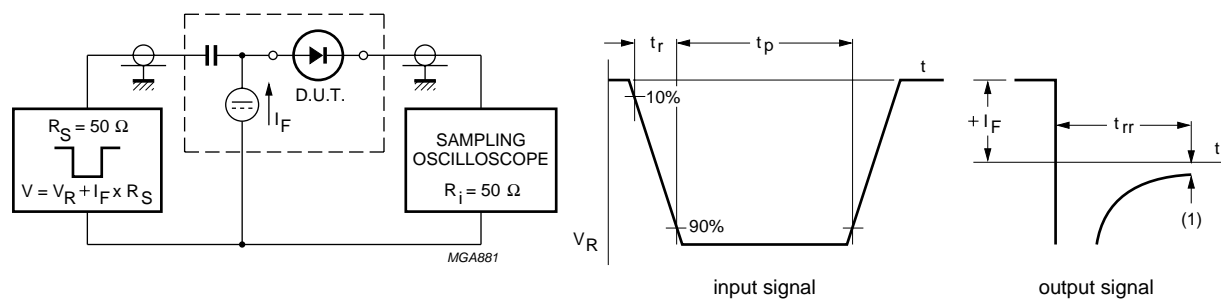

(1) $I_R = 3 \text{ mA}$

Input signal: reverse pulse rise time $t_r = 0.6 \text{ ns}$; reverse voltage pulse duration $t_p = 100 \text{ ns}$; duty factor $\delta = 0.05$;

Oscilloscope: rise time $t_r = 0.35 \text{ ns}$;

Circuit capacitance $C \leq 1 \text{ pF}$ (oscilloscope input + parasitic capacitance)

Fig.8 Reverse recovery time and waveforms.

General purpose diode

BAS321

PACKAGE OUTLINE

Plastic surface-mounted package; 2 leads

SOD323

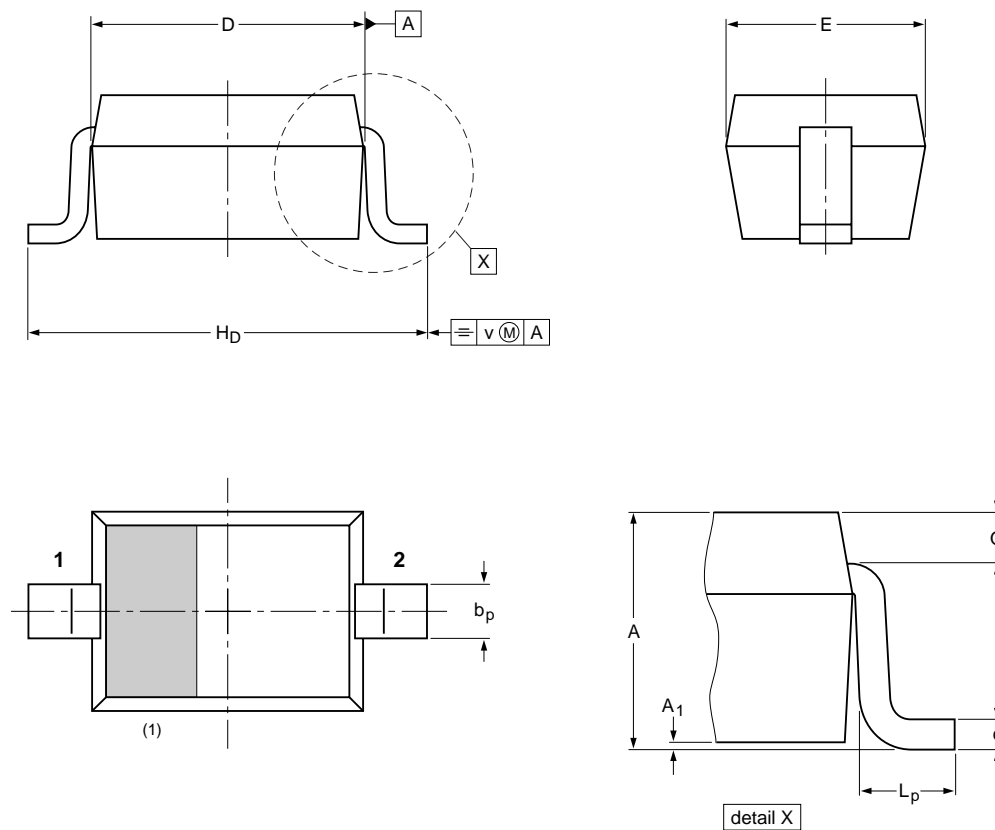

DIMENSIONS (mm are the original dimensions)

| UNIT | A | A ₁ max | b _p | c | D | E | H _D | L _p | Q | v |
|------|------------|-----------------------|----------------|--------------|------------|--------------|----------------|----------------|--------------|-----|
| mm | 1.1 0.8 | 0.05 | 0.40 0.25 | 0.25 0.10 | 1.8 1.6 | 1.35 1.15 | 2.7 2.3 | 0.45 0.15 | 0.25 0.15 | 0.2 |

Note

1. The marking bar indicates the cathode

| OUTLINE VERSION | REFERENCES | | | EUROPEAN PROJECTION | ISSUE DATE |
|--------------------|------------|-------|-------|------------------------|---------------------------------|
| | IEC | JEDEC | JEITA | | |
| SOD323 | | | SC-76 | | 03-12-17 06-03-16 |

General purpose diode

BAS321

DATA SHEET STATUS

| DOCUMENT STATUS ⁽¹⁾ | PRODUCT STATUS ⁽²⁾ | DEFINITION |
|--------------------------------|-------------------------------|---|
| Objective data sheet | Development | This document contains data from the objective specification for product development. |
| Preliminary data sheet | Qualification | This document contains data from the preliminary specification. |
| Product data sheet | Production | This document contains the product specification. |

Notes

1. Please consult the most recently issued document before initiating or completing a design.
2. The product status of device(s) described in this document may have changed since this document was published and may differ in case of multiple devices. The latest product status information is available on the Internet at URL <http://www.nxp.com>.

DISCLAIMERS

General — Information in this document is believed to be accurate and reliable. However, NXP Semiconductors does not give any representations or warranties, expressed or implied, as to the accuracy or completeness of such information and shall have no liability for the consequences of use of such information.

Right to make changes — NXP Semiconductors reserves the right to make changes to information published in this document, including without limitation specifications and product descriptions, at any time and without notice. This document supersedes and replaces all information supplied prior to the publication hereof.

Suitability for use — NXP Semiconductors products are not designed, authorized or warranted to be suitable for use in medical, military, aircraft, space or life support equipment, nor in applications where failure or malfunction of an NXP Semiconductors product can reasonably be expected to result in personal injury, death or severe property or environmental damage. NXP Semiconductors accepts no liability for inclusion and/or use of NXP Semiconductors products in such equipment or applications and therefore such inclusion and/or use is at the customer's own risk.

Applications — Applications that are described herein for any of these products are for illustrative purposes only. NXP Semiconductors makes no representation or warranty that such applications will be suitable for the specified use without further testing or modification.

Limiting values — Stress above one or more limiting values (as defined in the Absolute Maximum Ratings System of IEC 60134) may cause permanent damage to the device. Limiting values are stress ratings only and operation of the device at these or any other conditions

above those given in the Characteristics sections of this document is not implied. Exposure to limiting values for extended periods may affect device reliability.

Terms and conditions of sale — NXP Semiconductors products are sold subject to the general terms and conditions of commercial sale, as published at <http://www.nxp.com/profile/terms>, including those pertaining to warranty, intellectual property rights infringement and limitation of liability, unless explicitly otherwise agreed to in writing by NXP Semiconductors. In case of any inconsistency or conflict between information in this document and such terms and conditions, the latter will prevail.

No offer to sell or license — Nothing in this document may be interpreted or construed as an offer to sell products that is open for acceptance or the grant, conveyance or implication of any license under any copyrights, patents or other industrial or intellectual property rights.

Export control — This document as well as the item(s) described herein may be subject to export control regulations. Export might require a prior authorization from national authorities.

Quick reference data — The Quick reference data is an extract of the product data given in the Limiting values and Characteristics sections of this document, and as such is not complete, exhaustive or legally binding.

NXP Semiconductors

Customer notification

This data sheet was changed to reflect the new company name NXP Semiconductors, including new legal definitions and disclaimers. No changes were made to the technical content, except for package outline drawings which were updated to the latest version.

Contact information

For additional information please visit: <http://www.nxp.com>

For sales offices addresses send e-mail to: salesaddresses@nxp.com

© NXP B.V. 2009

All rights are reserved. Reproduction in whole or in part is prohibited without the prior written consent of the copyright owner.

The information presented in this document does not form part of any quotation or contract, is believed to be accurate and reliable and may be changed without notice. No liability will be accepted by the publisher for any consequence of its use. Publication thereof does not convey nor imply any license under patent- or other industrial or intellectual property rights.

Printed in The Netherlands

R76/02/pp9

Date of release: 2004 Jan 26

Document order number: 9397 750 12589

