

4-channel H-bridge type BTL driver for CD players

BA6892FP

The BA6892FP is a 4-channel H-bridge BTL driver for CD players. Independent power supplies for each predriver and power driver assure efficient operation at low voltages. Each channel is independently mutable.

●Applications

CD players, CD-ROM drives and other optical disc devices

●Features

- 1) 4-channel BTL driver in a HSOP 28-pin package, ideal for application miniaturization.
- 2) Wide dynamic range.
- 3) Driver gain is adjustable with an attached resistor.
- 4) Independent power supply for each preamplifier and power amplifier, for drives that operate efficiently on low voltages.
- 5) Power amplifier current drops to an extremely low level when the preamplifier power supply is lowered, allowing for a standby mode.

●Absolute maximum ratings (Ta = 25°C)

Parameter	Symbol	Limits	Unit
Power supply voltage	V _{CC}	18	V
Power dissipation	P _d	1800*	mW
Operating temperature	T _{opr}	-30~+85	°C
Storage temperature	T _{stg}	-55~+150	°C

* Reduced by 14.4 mW for each increase in Ta of 1°C over 25°C.

●Recommended operating conditions (Ta = 25°C)

Parameter	Symbol	Min.	Typ.	Max.	Unit
Predriver supply voltage	V _{CCPRE}	3.0	—	14.0	V
Powerdriver supply voltage	V _{CCPOW}	1.5	—	14.0	V

● Block diagram

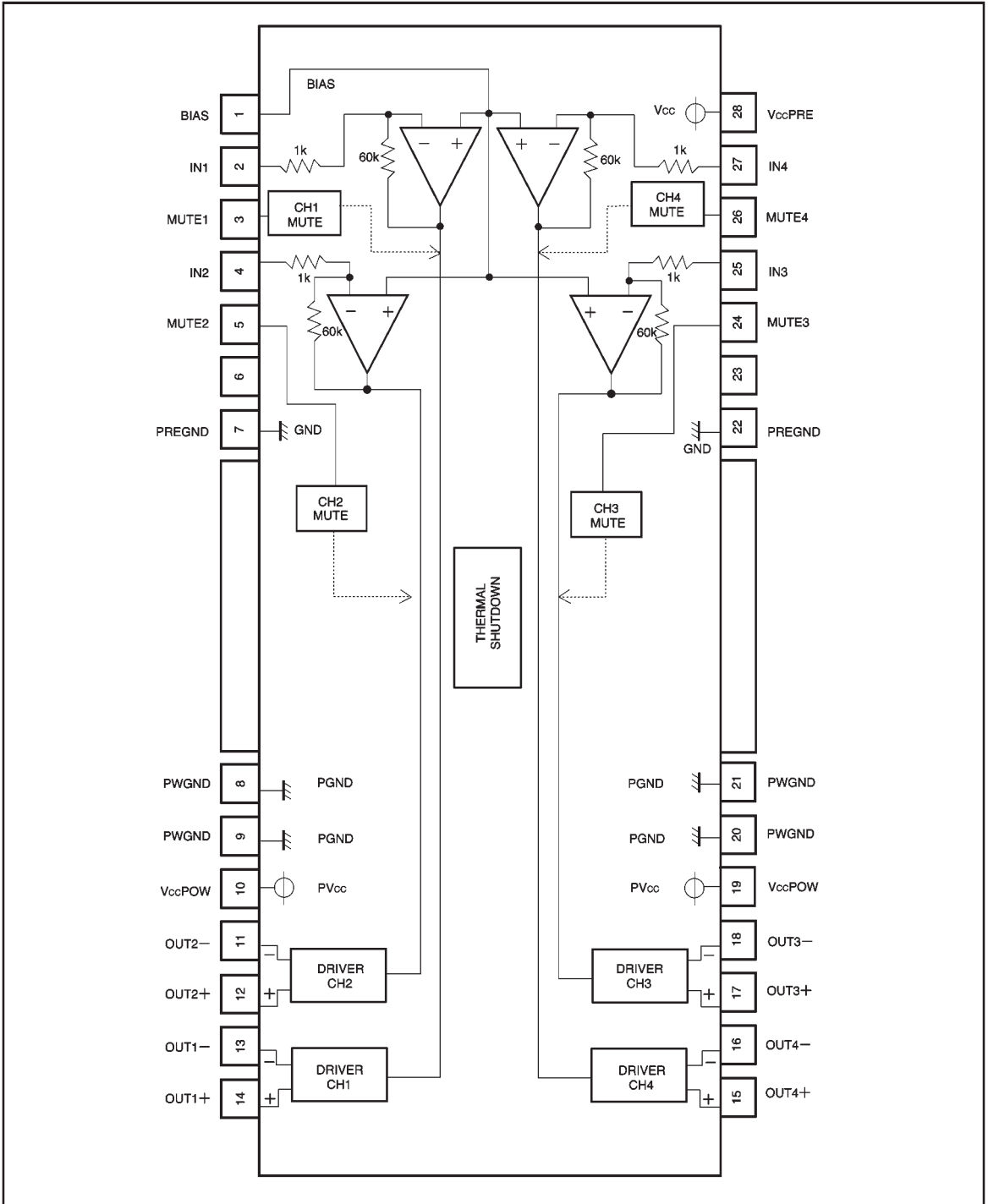

● Pin descriptions

Pin No.	Pin name	Function
1	BIAS	Bias input
2	IN1	Channel 1 input
3	MUTE1	Channel 1 mute
4	IN2	Channel 2 input
5	MUTE2	Channel 2 mute
6	—	Test pin
7	PREGND	Pre-ground
8	PWGND	Power ground
9	PWGND	Power ground
10	VccPOW	Power Vcc
11	OUT2—	Channel 2 negative output
12	OUT2+	Channel 2 positive output
13	OUT1—	Channel 1 negative output
14	OUT1+	Channel 1 positive output
15	OUT4+	Channel 4 positive output
16	OUT4—	Channel 4 negative output
17	OUT3+	Channel 3 positive output
18	OUT3—	Channel 3 negative output
19	VccPOW	Power Vcc
20	PWGND	Power ground
21	PWGND	Power ground
22	PREGND	Pre-ground
23	—	N.C.
24	MUTE3	Channel 3 mute
25	IN3	Channel 3 input
26	MUTE4	Channel 4 mute
27	IN4	Channel 4 input
28	VccPRE	Pre Vcc

Notes: (1) Positive and negative output of the driver is relative to the polarity of the input pins.

(For example, pin 14 is HIGH when pin 2 input is HIGH.)

(2) The radiating fin is internally shorted by pin 8 (GND).

(3) Pin 6 is the test pin and should be left unconnected.

● Input / output circuits

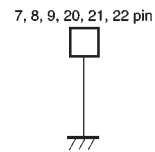
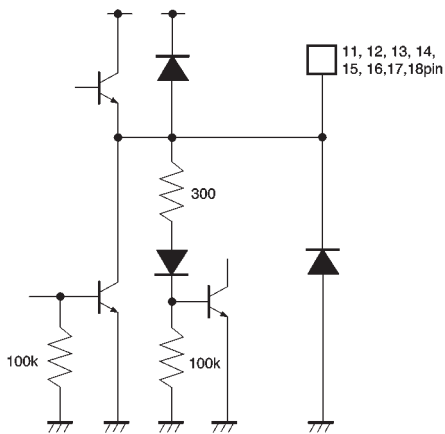
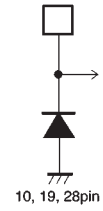
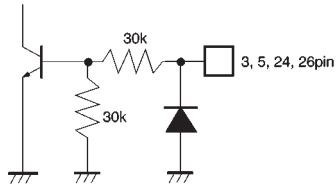
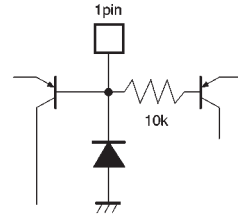
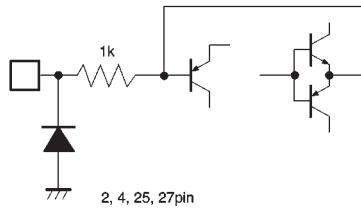

- Electrical characteristics (unless otherwise noted, $T_a = 25^\circ\text{C}$, $V_{\text{CCPRE}} = V_{\text{CCPOW}} = 4\text{V}$, $\text{BIAS} = 2\text{V}$, $R_L = 8\Omega$, $R_{\text{IN}} = 9.1\text{k}\Omega$)

Parameter	Symbol	Min.	Typ.	Max.	Unit	Conditions	Measurement Circuit
Supply current 1 (V_{CCPRE})	I_{Q1}	—	3.6	6.0	mA	Open input	Fig. 1
Supply current 2 (V_{CCPOW})	I_{Q2}	—	—	10	μA	Open input	Fig. 1
Standby current	I_{ST}	—	—	1	μA	$V_{\text{CCPRE}}=\text{OFF}$, $V_{\text{CCPOW}}=4\text{V}$	Fig. 1
Input offset voltage	V_{OI}	-5.5	0.7	5.5	mV		Fig. 1
Output offset voltage	V_{OO}	-35	0	35	mV		Fig. 1
Dead zone width	V_{DB}	1	4	10	mV	Total for positive and negative	Fig. 1
Maximum output amplitude	V_{OM}	2.0	2.5	—	V	$V_{\text{IN}}=\pm 0.7\text{V}$	Fig. 1
Voltage gain	G_{VC}	11	14	17	dB	$V_{\text{IN}}=\pm 0.3\text{V}$	Fig. 1
Voltage gain differential (positive and negative)	ΔG_{VC}	-1.9	0	1.0	dB		Fig. 1
MUTE-ON voltage	V_{MON}	2.0	—	—	V		Fig. 1
MUTE-OFF voltage	V_{MOFF}	—	—	0.5	V		Fig. 1

● Measurement circuit

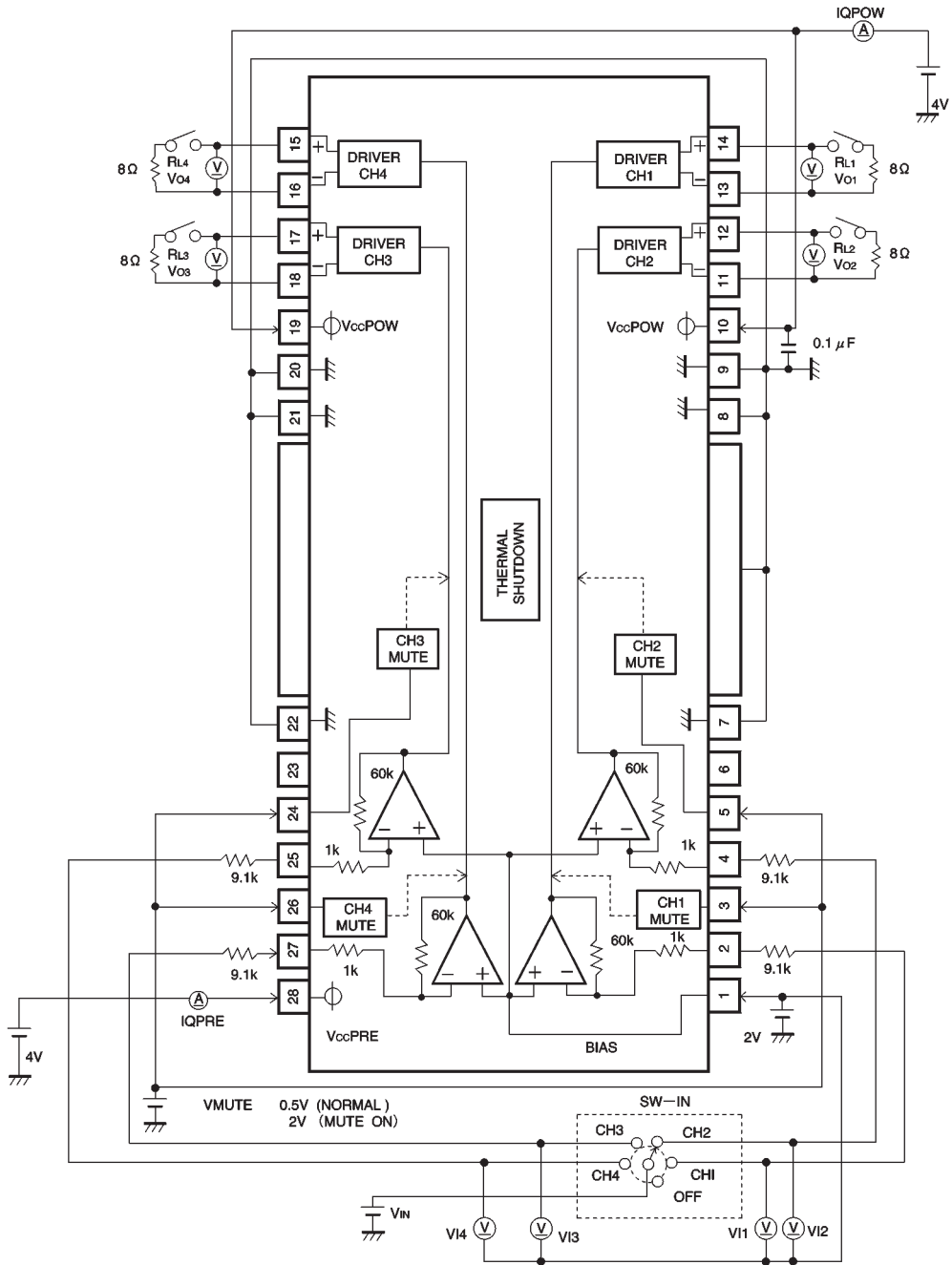
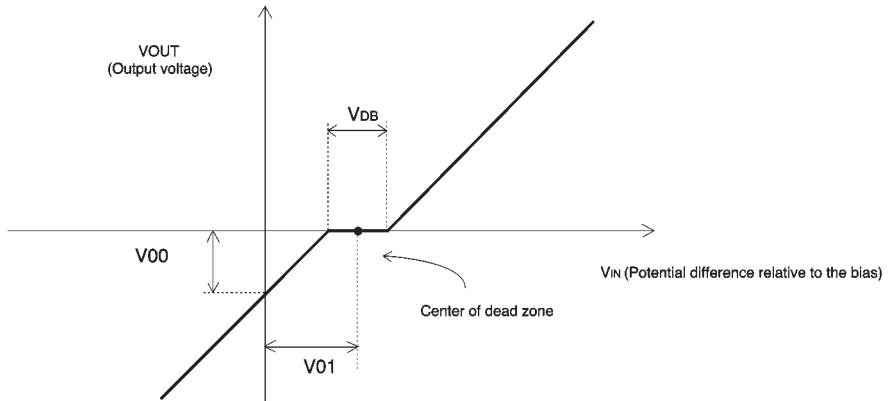

Fig.1

	V _{IN}	I _N	V _{PRE}	R _L	Measurement point
I _{Q1}	OFF	OFF	ON	OFF	I _{QPRE}
I _{Q2}	OFF	OFF	ON	OFF	I _{QPOW}
I _{ST}	OFF	OFF	OFF	OFF	I _{QPOW}
V _{O1}	OFF	Channel1~4	ON	OFF	V _{I1~4}
V _{OO}	0V	Channel1~4	ON	ON	V _{O1~4}
V _{DB}	Sweep from -50 mV to 50 mV	Channel1~4	ON	ON	Verify range of V _{IN} where V _{O1~4} are 0 mV
V _{OM}	±2.0V	Channel1~4	ON	ON	V _{O1~4}
G _{VC}	±0.3V	Channel1~4	ON	ON	20 log ((V _{O1~4}) / V _{IN})
ΔG _{VC}	±0.3V	Channel1~4	ON	ON	Differential between G _{VC} +G _{VC}

Note: Because the input offset is also the center of the dead zone, an output will be generated at the point where V_{IN} = V_{BIAS} when the input offset is outside the dead zone width (4 mV). This is the output offset voltage.



●Application example

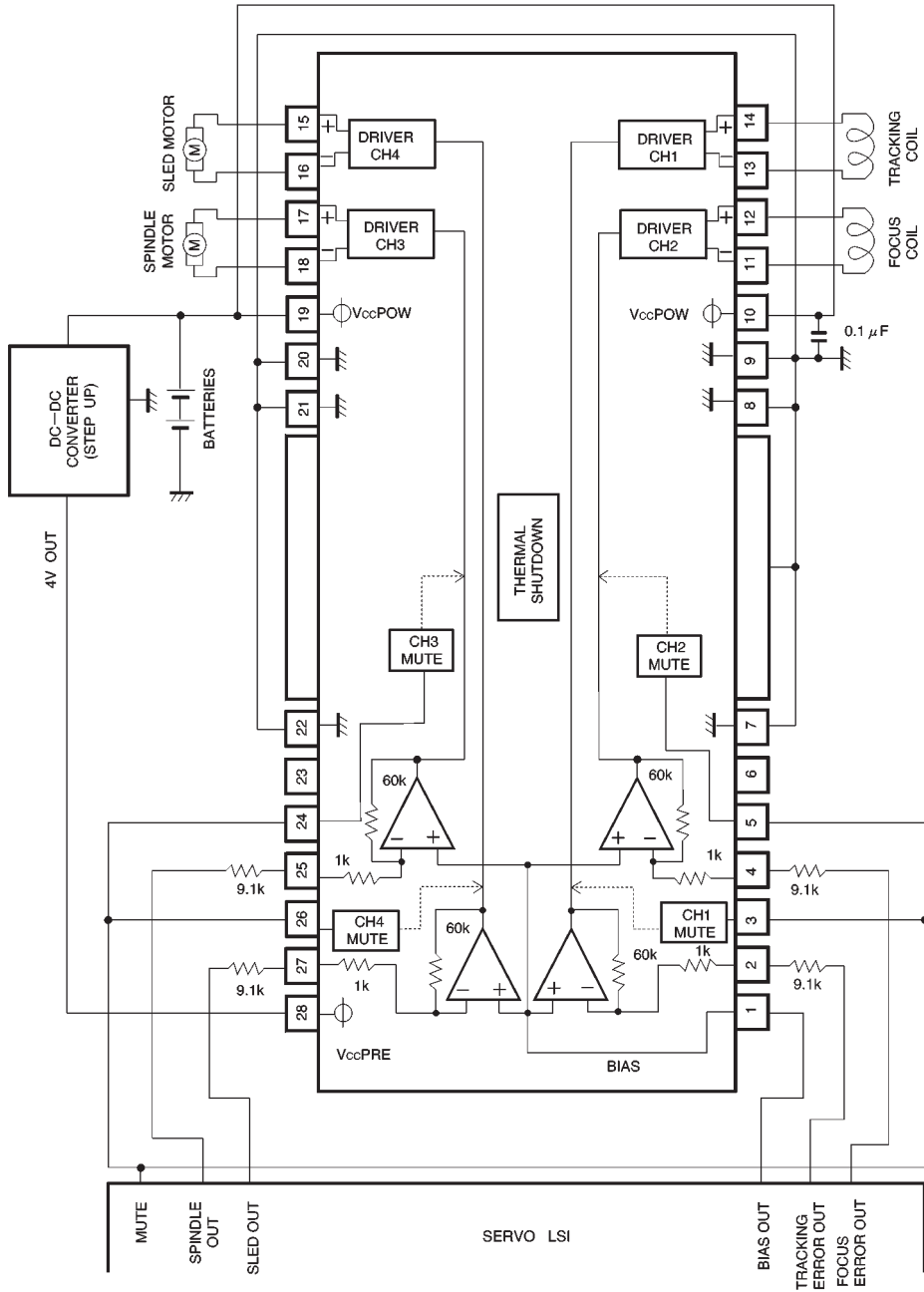

Fig. 2

● Operation notes

- (1) The BA6892FP has an internal thermal shutdown circuit. Output current is muted when the chip temperature exceeds 175°C (typically) and restored when the chip temperature falls to 150°C (typically).
- (2) The mute pin operates normally when open and at the LOW level (below 0.5V), but mutes the output when raised to the HIGH level (above 2V). A high impedance is output during muting. The mute pin functions independently for each channel.
- (3) Dead zone width is determined as follows:
Dead zone width = input resistance (attached resistor +

- internal input resistor 1kΩ) × 0.2μA
 Dead zone width varies according to the gain setting as defined in the preceding equation.
 Example: When attached input resistor = 9.1kΩ, VDB = (9.1k+1k) × 0.2μ ≅ 2mV
 Output pins output high impedance in a dead zone equal to AmV (total for positive and negative).
 (4) Be sure to connect the IC to a 0.1μF bypass capacitor to the power supply, at the base of the IC.
 (5) Connect the radiating fin to an external ground.

● Electrical characteristic curves

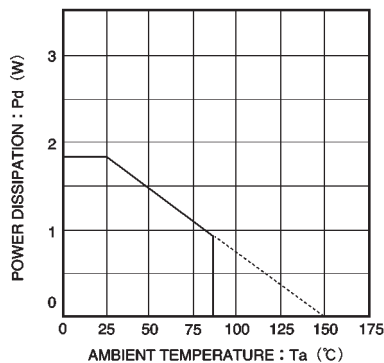

Fig. 3 Thermal derating curve

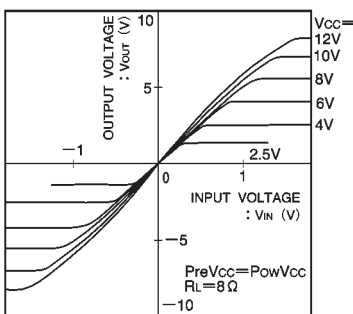

Fig. 4 I/O characteristics (Pre and power driver Vcc variation)

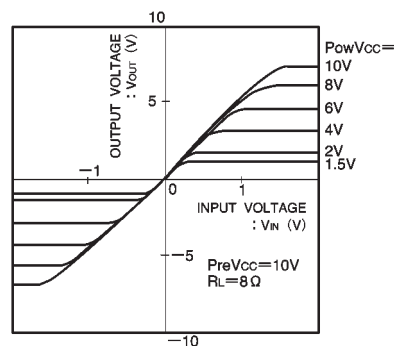

Fig. 5 I/O characteristics (powerdriver Vcc variation)

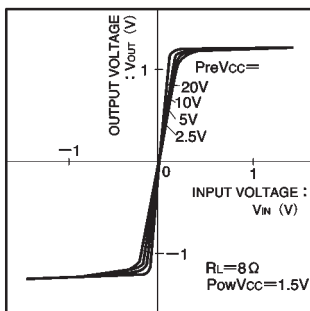

Fig. 6 I/O characteristics (pre-driver Vcc variation)

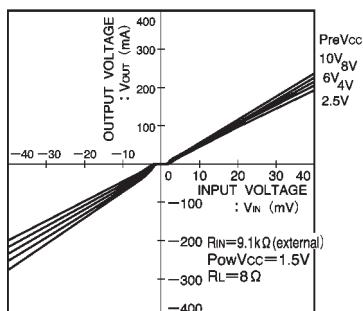

Fig. 7 Dead zone I/O characteristics (pre-driver Vcc variation)

● External dimensions (Units: mm)

