

Voice coil motor driver

BA6832FS

The BA6832FS is a voice coil motor driver used for moving the heads of hard disc and mass-storage floppy disc drives.

●Applications

HDD disc and mass-storage FDD

●Features

- 1) Output current is controlled by the V_{ctl} - V_{ref} voltage.
- 2) Retraction control pin.
- 3) Chip enabling pin.
- 4) Internal thermal shutdown circuit.

●Absolute maximum ratings ($T_a = 25^\circ\text{C}$)

Parameter	Symbol	Limits	Unit
Applied voltage	V_{cc}	15	V
Power dissipation	P_d	1200* ¹	mW
Operating temperature	T_{opr}	-25~+75	°C
Storage temperature	T_{stg}	-55~+150	°C
Output current	I_{oMAX}	1200* ²	mA

*1 When mounted on a glass epoxy board(90 × 50 × 1.6 mm).
Reduced by 9.6 mW for each increase in T_a of 1°C over 25 °C.

*2 Should not exceed P_d or ASO values.

●Recommended operating conditions

Parameter	Symbol	Limits	Unit
Operating power supply voltage	V_{cc}	4.5~13.8	V

● Block diagram

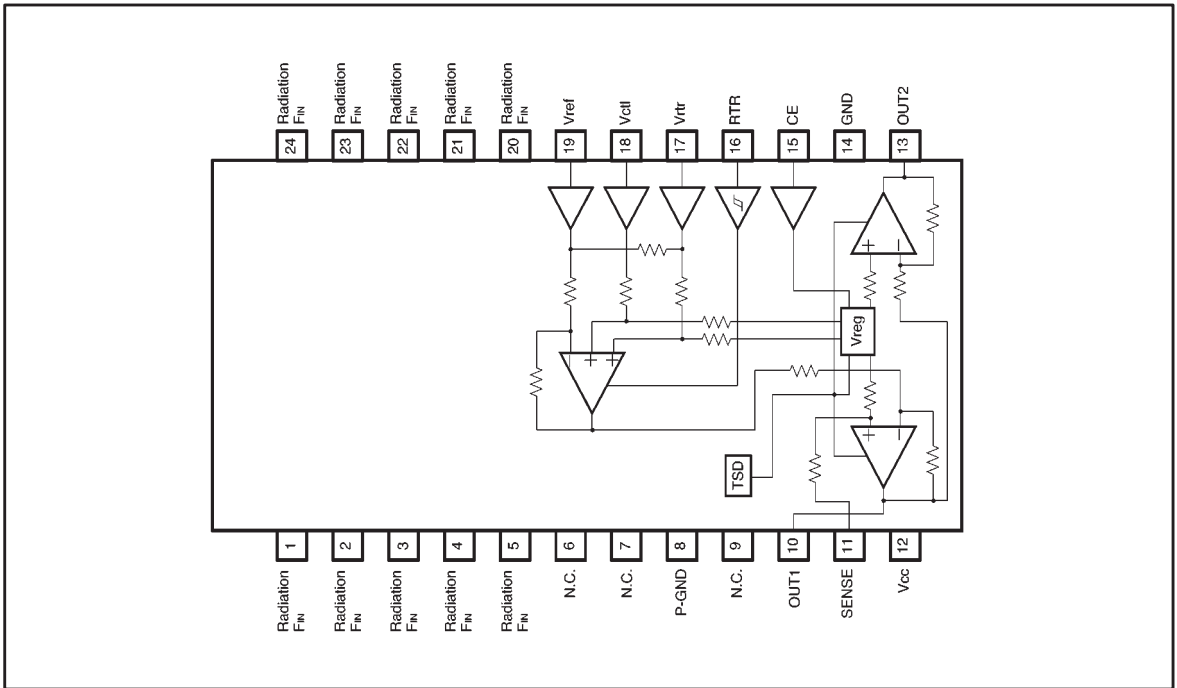

● Pin descriptions

Pin No.	Pin name	Function
1	F _{IN}	Radiation F _{IN}
2	F _{IN}	Radiation F _{IN}
3	F _{IN}	Radiation F _{IN}
4	F _{IN}	Radiation F _{IN}
5	F _{IN}	Radiation F _{IN}
6	N.C.	N.C.
7	N.C.	N.C.
8	P-GND	Power ground
9	N.C.	N.C.
10	OUT1	OUTPUT1
11	SENSE	Current sensing
12	V _{CC}	Power supply
13	OUT2	OUTPUT2
14	GND	Signal ground
15	CE	Chip enabling
16	RTR	Retract/normal mode switching
17	V _{rtr}	Retraction input
18	V _{ctl}	Control input
19	V _{ref}	External reference input
20	F _{IN}	Radiation F _{IN}
21	F _{IN}	Radiation F _{IN}
22	F _{IN}	Radiation F _{IN}
23	F _{IN}	Radiation F _{IN}
24	F _{IN}	Radiation F _{IN}

● Input / output circuits

(1) V_{ctl}, V_{ref} (18, 19pin)

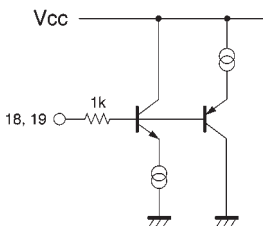

(Resistance, in Ω, is typical value)

(2) CE, RTR, VRTR, (15, 16, 17pin)

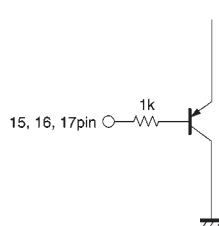

(Resistance, in Ω, is typical value)

(3) OUT1, OUT2 (10, 13pin)

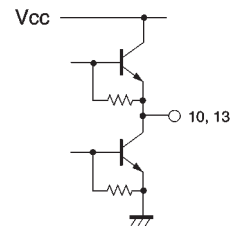

●Electrical characteristics (unless otherwise noted, Ta = 25°C and Vcc = 12V)

Parameter	Symbol	Min.	Typ.	Max.	Unit	Conditions
Quiescent current	I _{CCS}	—	0.15	0.4	mA	I _o =0 CE=H
	I _{CC}	—	7.5	15	mA	I _o =0 CE=L
〈CE〉						
Input high level voltage	V _{IHC}	2.0	—	—	V	
Input low level voltage	V _{ILC}	—	—	0.8	V	
Input current	I _{CEL}	−2.5	—	+2.5	μA	CE=V _{CC}
〈ctl, ref Amp〉						
Input current	I _{IN}	−2.5	—	+2.5	μA	V _{ref} =6V, V _{ctl} =6V
Input offset current	ΔI _{IN}	−0.5	—	+0.5	μA	
Common-mode voltage	V _B	4	—	8	V	
〈V _{ctl} −V _{OUT} 〉						
Transfer gain	G _C	0.8	1	1.2	V / V	ΔVs/Δ(V _{ctl} −V _{ref})
Input conversion offset voltage	V _{CTL0}	−15	−5	+5	mV	V _{ref} =6V
Gain band width	F _C	—	56	—	kHz	GC=−3dB
Phase shift	ΔP	—	13	—	deg	f=10kHz
Harmonic distortion ratio	H _D	—	—	2	%	f=1kHz, I _o ≐0.1Arms
〈V _{rtr} −V _{OUT} 〉						
Offset voltage	V _{RTRO}	−25	0	+25	mV	V _{ref} =6V
Transfer gain	G _R	0.08	0.1	0.12	V / V	ΔVs/ΔV _{rtr}
〈Power Amp〉						
Quiescent output voltage	V _O	5.3	5.65	6.0	V	R _L =10Ω
Output saturation voltage	V _{OHL}	—	1.8	2.4	V	I _o =0.8A, total of high- and low-sides
Leakage current	I _L	—	—	4	mA	V _{CE} =15V

●Circuit operation

(1) Output current control

The method of output current control depends on whether the RTL pin is HIGH or LOW.

1) When the RTL pin is LOW

The voltage V_{RS} that develops across the resistor R_S between pins 10 and 11 (with reference to pin 10) is controlled by the voltage between V_{ctl} (pin 18) and V_{ref} (pin 19) :

$$V_{RS} = (V_{ctl} - V_{ref}) \times 1 \quad (\text{Typ.})$$

The output current I_o is given by :

$$I_o = (V_{ctl} - V_{ref}) / R_S \quad (\text{Typ.})$$

where the positive direction is from pin 13 to pin 10. Therefore, the voltage-current conversion gain for the control input is determined by the R_S value. The gain band width in this case is 80kHz (typical).

2) When the RTL pin is HIGH

The V_{RS} voltage (with reference to pin 10) is controlled by the V_{rtr} (pin 17) voltage (with reference to the ground) :

$$V_{RS} = -0.1 \times V_{rtr} / R_S$$

3) RTR threshold

The RTR pin threshold voltage is 1.2~1.3V. The pin has a hysteresis width of about 40mV.

(2) Standby mode

The standby mode is activated when the CE pin is LOW; the circuit current is reduced to 0.15mA (typical), and the output pins are put to the high impedance state. The operation mode is activated when the CE pin is HIGH, and the output current becomes controllable. The pin's threshold voltage is 1.2~1.3V.

(3) Internal reference voltage

The internal reference voltage V_{reg} is given by :

$$V_{reg} = (V_{CC} - V_F) / 2$$

where $V_{reg} = 5.65$ when $V_{CC} = 12V$. The output pins (pins 10 and 13) operate with reference to V_{reg} .

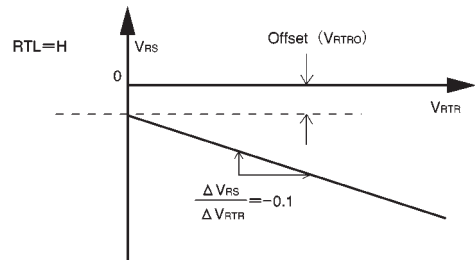
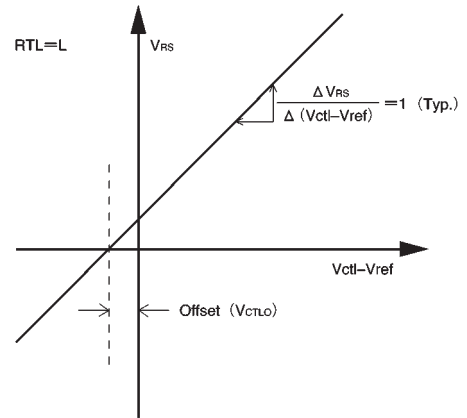

●Application example

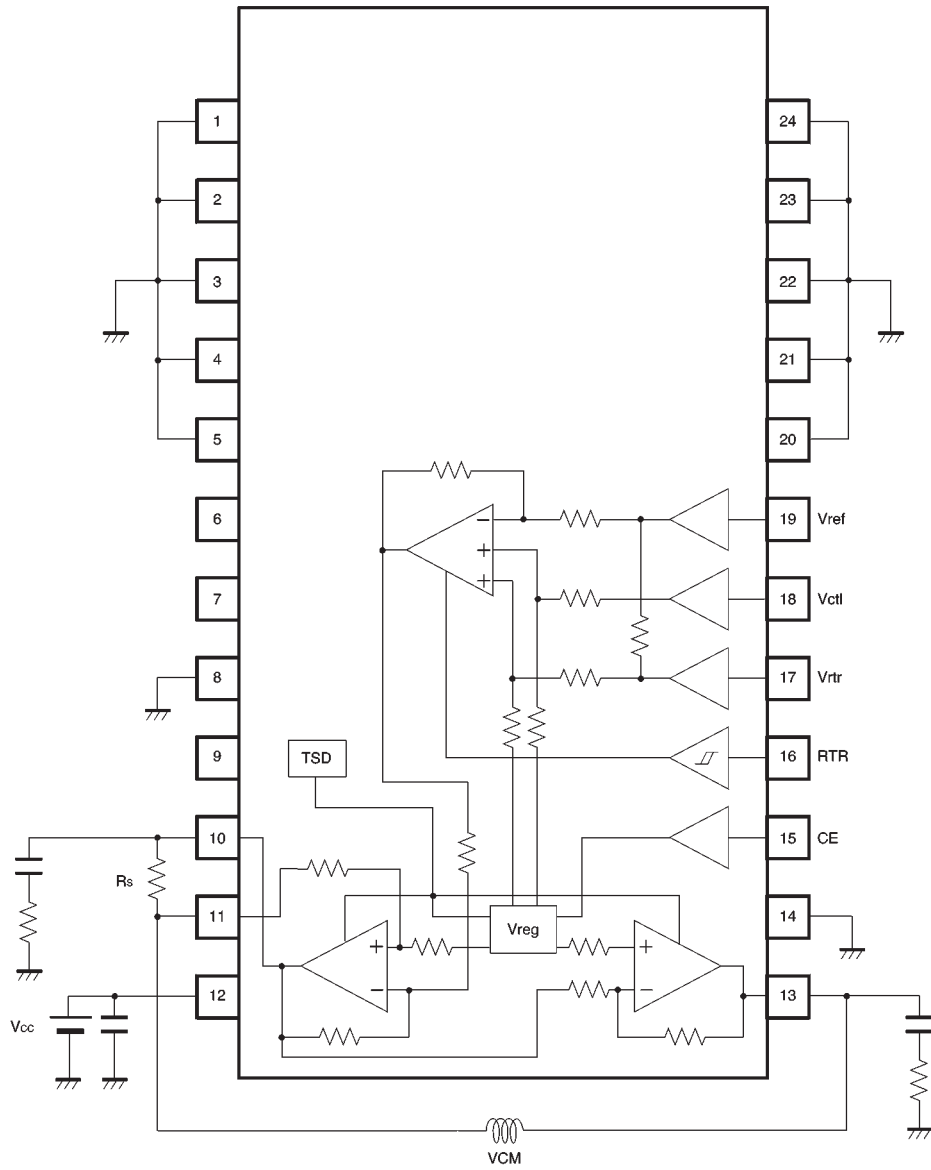

Fig.1

● Operation notes

(1) Thermal shutdown circuit

The IC has a built-in thermal shutdown circuit. The circuit turns off all the driver outputs when the chip junction temperature rises to about 175°C (typical). There is a temperature difference of 20°C (typical) between the temperatures at which the circuit is activated and deactivated.

(2) Vctl, Vref, and input pins

If voltage is applied to Vctl (pin 18) and Vref (pin 19) when the Vcc voltage is outside the operating voltage, the driver outputs are turned on and a current may flow through the connected motor. The voltage of each input pin should be less than Vcc and more than the ground voltage.

(3) Temperature dependence of quiescent circuit current (Icc)

When the IC temperature rises with Vctl=Vref and CE=LOW in the quiescent mode, Icc may increase due to the temperature dependence of the standby current that flows through the high- and low-side transistors.

(4) Package power dissipation

The IC power dissipation changes greatly with the supply voltage and the output current. Give full consideration to the power dissipation rating when setting the supply voltage and the output current.

● Electrical characteristic curves

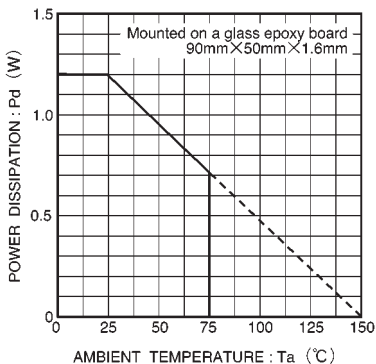

Fig.2 Power dissipation curve

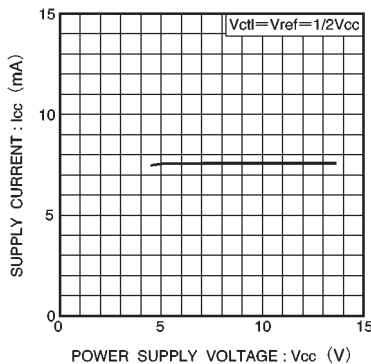

Fig.3 Supply current vs. power supply voltage

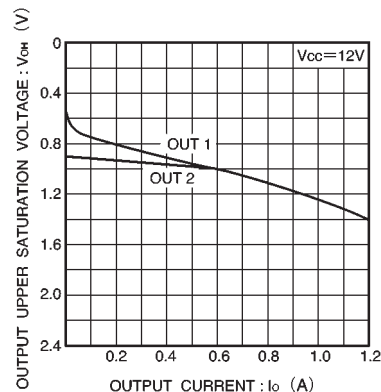

Fig.4 High-side output saturation voltage vs. output current

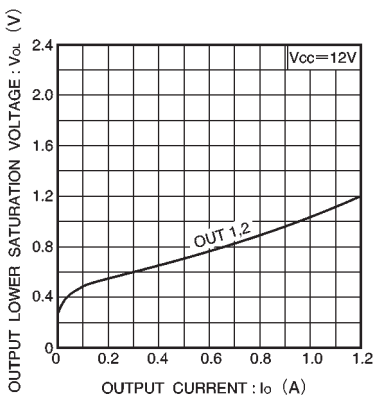

Fig.5 Low-side output saturation voltage vs. output current

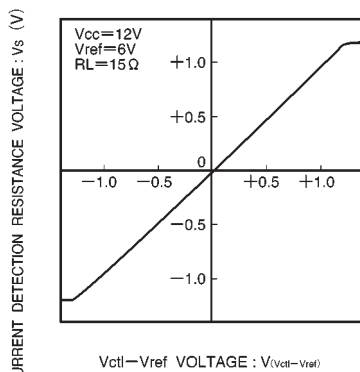

Fig.6 Current detection resistance voltage vs. the Vctl-Vref voltage

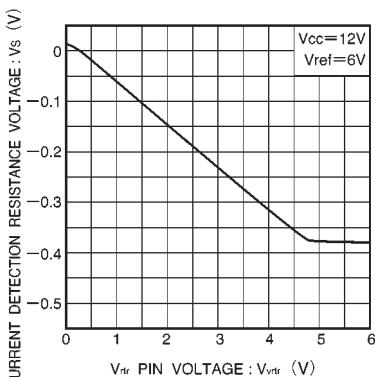

Fig.7 Current detection resistance voltage vs. the Vrtr-pin voltage

● External dimensions (Units: mm)

