

**Power line filters for three-phase systems**  
**Rated voltage 440/250 V~, 50/60 Hz**  
**Rated current 8 A to 180 A**

**Construction**

- Three-line filter
- Metal case

**Features**

- High insertion loss
- Low leakage current
- Easy to install
- Degree of protection: IP 20<sup>1)</sup>
- Space-saving design
- Design complies with  
EN 133200, UL 1283, CSA 22.2 No.8 1986
- Optimized for long motor cables  
and operation under full load
- UL and CSA approval pending

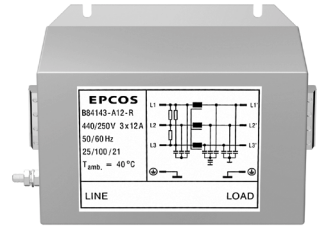

**Applications**

- Frequency converters for motor drives, e.g.
  - elevators
  - pumps
  - traction systems
  - conveyor systems
  - HVAC systems (heating, ventilation and air conditioning)
- Wind farms
- Power supplies

**Terminals**

- Safe-to-touch terminal blocks

**Marking**

Marking on component:

Manufacturer's logo, ordering code,  
rated voltage, rated current,  
rated temperature, climatic category,  
date code

Minimum marking on packaging:

Manufacturer's logo, ordering code

1) In accordance with IEC 60529:1989; EN 60529:1991; DIN VDE 0470-1

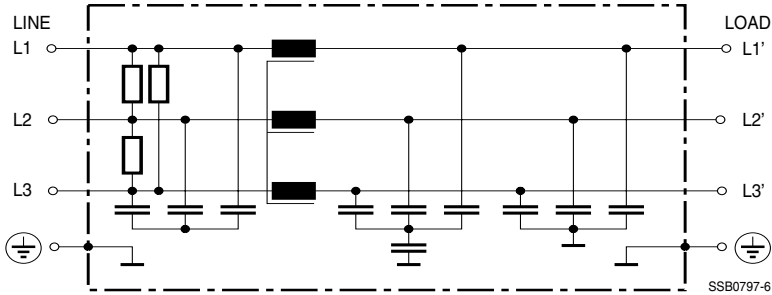
**Typical circuit diagram**

**Technical data**

Rated voltage $V_R$	440/250 V~, 50/60 Hz
Rated current $I_R$	Referred to 40 °C ambient temperature
Test voltage $V_P$	1770 V~, 2 s (line/line) 2700 V~, 2 s (lines/case)
Overload capability	1,5 · $I_R$ for 3 min per hour or 2,5 · $I_R$ for 30 s per hour
Leakage current $I_{leak}$	at 400 V~, 50 Hz
Climatic category	25/100/21 (- 25 °C/100 °C/21 days damp heat test) in accordance with EN 60068-1

**Characteristics and ordering codes**

$I_R$ A	Terminal cross section mm <sup>2</sup>	$I_{leak}$ mA	$R_{typ}$ mΩ	Approx. weight kg	Ordering code
8	4	< 3,5	40	2,2	B84143-A8-R
12	4	< 3,5	20	2,2	B84143-A12-R
16	4	< 3,5	15	2,2	B84143-A16-R
25	10	< 3,5	8	3,7	B84143-A25-R
36	10	< 3,5	3,8	3,7	B84143-A36-R
50	10	< 6	2,0	4,0	B84143-A50-R
80	25	< 6	1,0	9,5	B84143-A80-R
120	50	< 6	0,75	10	B84143-A120-R
150	50	< 6	0,4	10	B84143-A150-R
180	95	< 6	0,4	13	B84143-A180-R

For filters for higher currents see B84143-B<sup>+</sup>-S20, [page 255](#).

In comparison with the former series B84143-A<sup>+</sup>-S these filters are smaller, lower in weight and optimized in price.

Dimensional drawings

B84143-A8-R ... B84143-A16-R

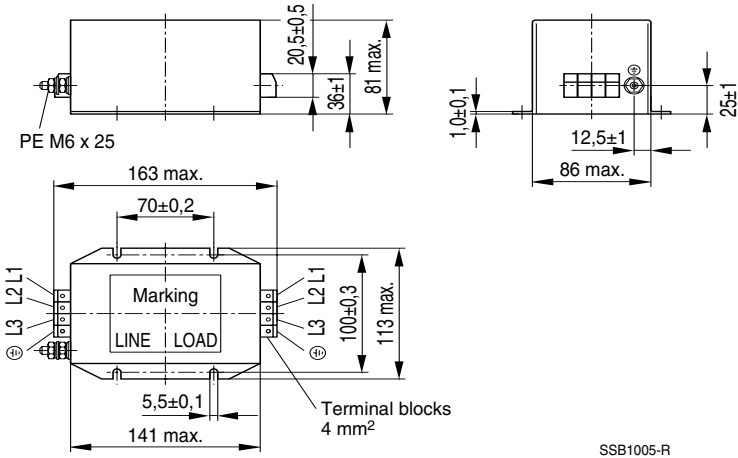

B84143-A25-R ... A50-R

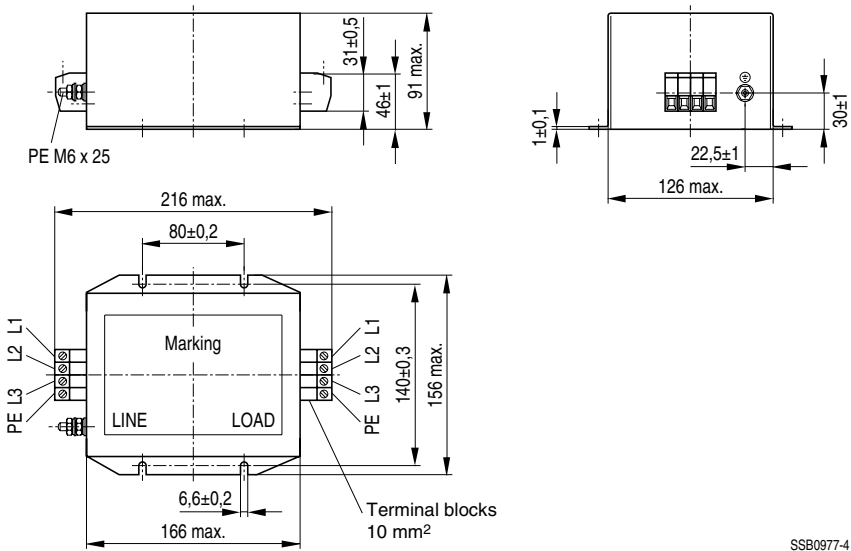

**B84143-A80-R**

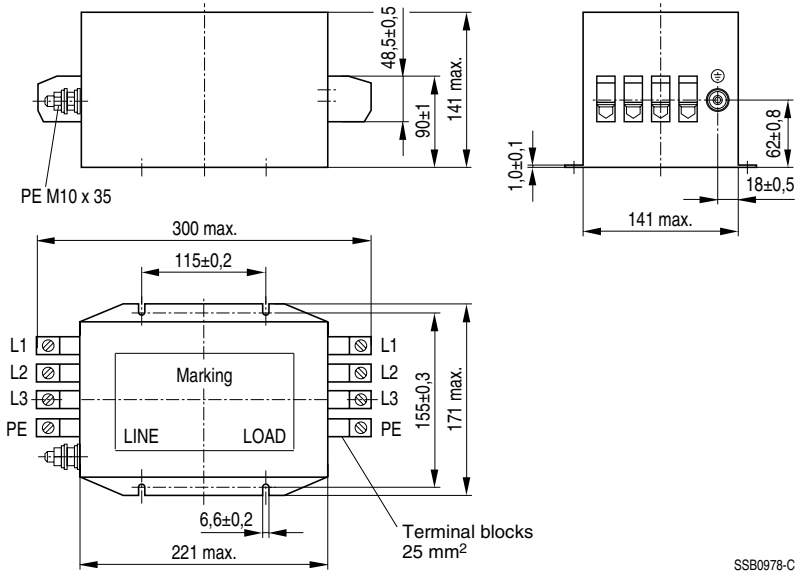

**B84143-A120-R, B84143-A150-R**

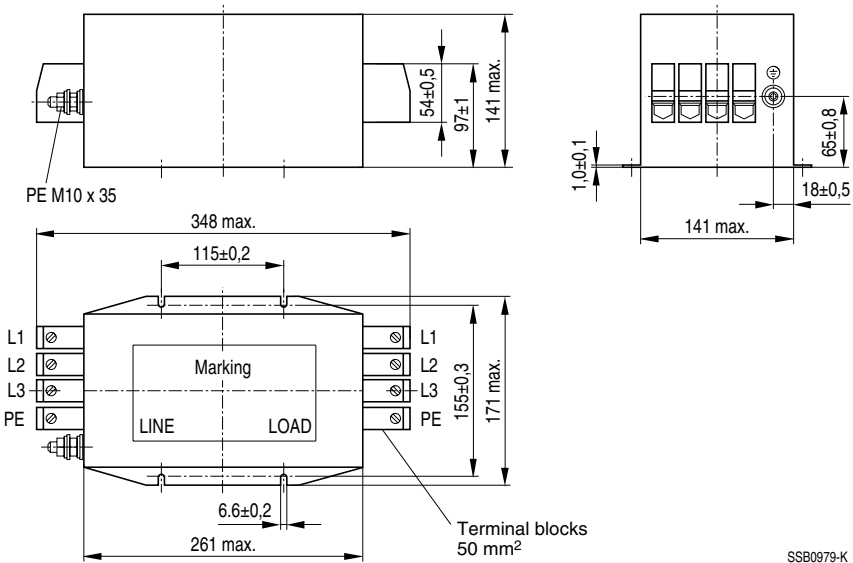

B84143-A180-R

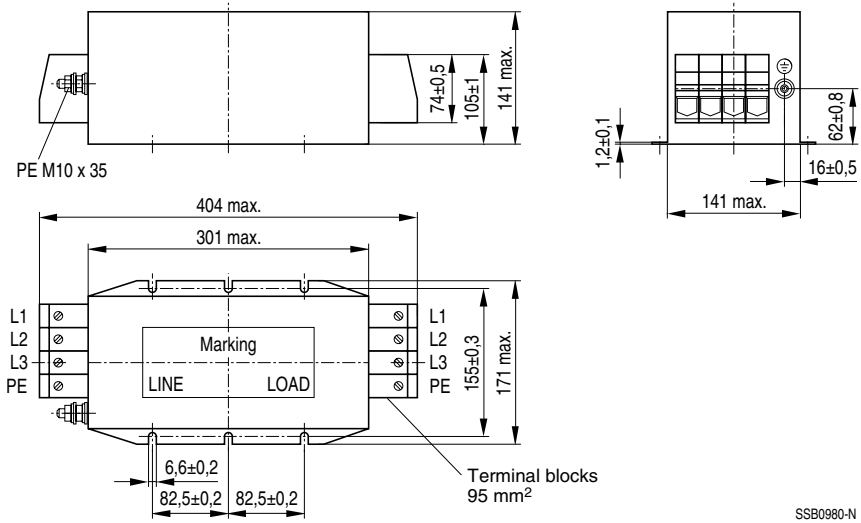

for Converters and Power Electronics

Insertion loss (typical values at  $Z = 50 \Omega$ )

- unsymmetrical, adjacent branches terminated
- ..... common mode, all branches in parallel (asymmetrical)
- - - - - differential mode (symmetrical)

B84143-A8-R

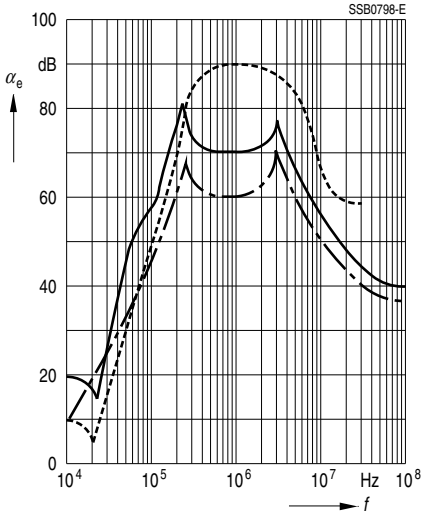

B84143-A12-R

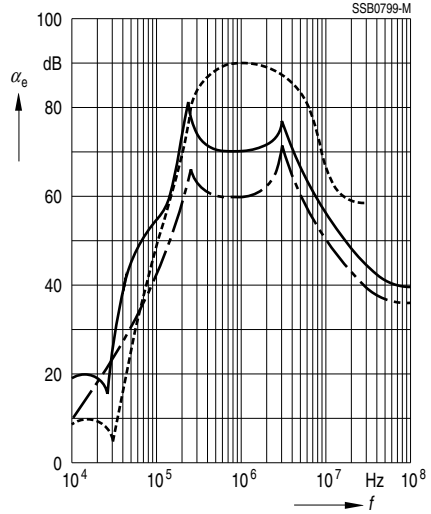

B84143-A16-R

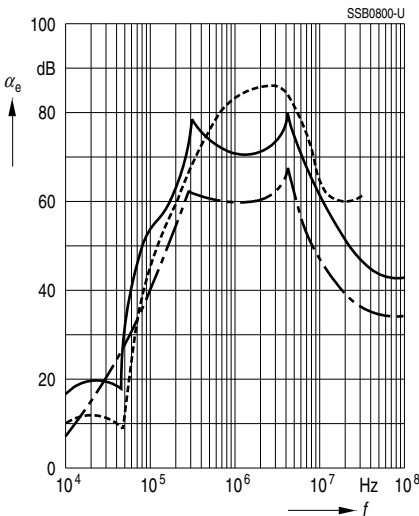

B84143-A25-R

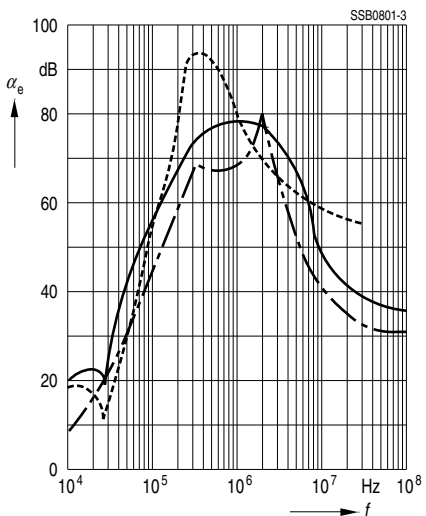

for Converters and Power Electronics

**Insertion loss** (typical values at  $Z = 50 \Omega$ )

- unsymmetrical, adjacent branches terminated
- - - - - common mode, all branches in parallel (asymmetrical)
- - - - - differential mode (symmetrical)

B84143-A36-R

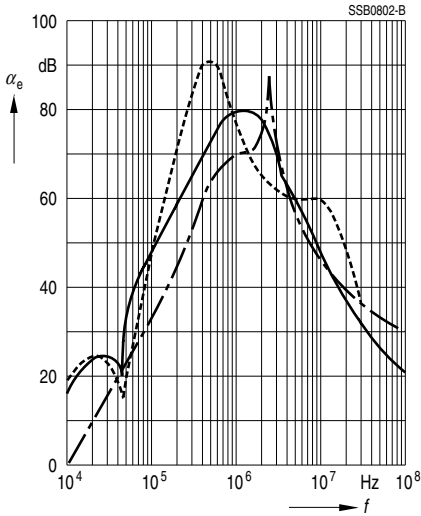

B84143-A50-R

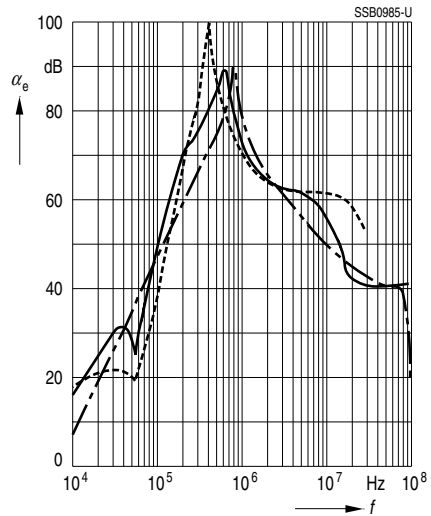

B84143-A80-R

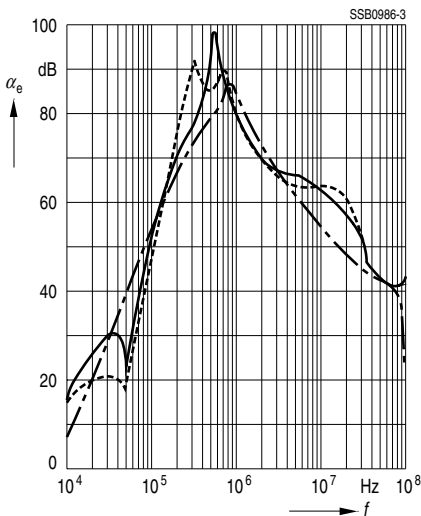

B84143-A120-R ... B84143-A180-R

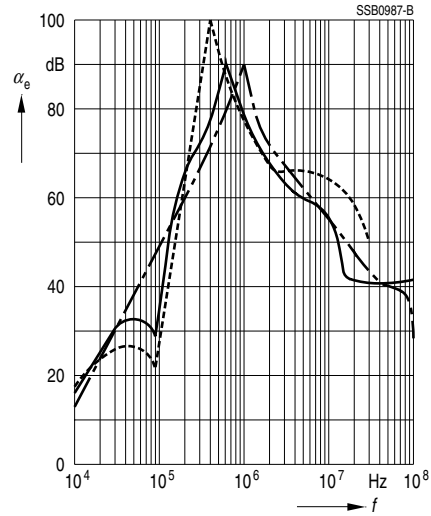



**Herausgegeben von EPCOS AG**

**Marketing Kommunikation, Postfach 80 17 09, 81617 München, DEUTSCHLAND**

© EPCOS AG 2000. Alle Rechte vorbehalten. Vervielfältigung, Veröffentlichung, Verbreitung und Verwertung dieser Broschüre und ihres Inhalts ohne ausdrückliche Genehmigung der EPCOS AG nicht gestattet.

Mit den Angaben in dieser Broschüre werden die Bauelemente spezifiziert, keine Eigenschaften zugesichert. Bestellungen unterliegen den vom ZVEI empfohlenen Allgemeinen Lieferbedingungen für Erzeugnisse und Leistungen der Elektroindustrie, soweit nichts anderes vereinbart wird.

Diese Broschüre ersetzt die vorige Ausgabe.

Fragen über Technik, Preise und Liefermöglichkeiten richten Sie bitte an den Ihnen nächstgelegenen Vertrieb der EPCOS AG oder an unsere Vertriebsgesellschaften im Ausland.

Bauelemente können aufgrund technischer Erfordernisse Gefahrstoffe enthalten. Auskünfte darüber bitten wir unter Angabe des betreffenden Typs ebenfalls über die zuständige Vertriebsgesellschaft einzuholen.

**Published by EPCOS AG**

**Marketing Communications, P.O. Box 80 17 09, 81617 Munich, GERMANY**

© EPCOS AG 2000. All Rights Reserved. Reproduction, publication and dissemination of this brochure and the information contained therein without EPCOS' prior express consent is prohibited.

The information contained in this brochure describes the type of component and shall not be considered as guaranteed characteristics. Purchase orders are subject to the General Conditions for the Supply of Products and Services of the Electrical and Electronics Industry recommended by the ZVEI (German Electrical and Electronic Manufacturers' Association), unless otherwise agreed.

This brochure replaces the previous edition.

For questions on technology, prices and delivery please contact the Sales Offices of EPCOS AG or the international Representatives.

Due to technical requirements components may contain dangerous substances. For information on the type in question please also contact one of our Sales Offices.