

@vic AV3842B / 3843B LINEAR INTEGRATED CIRCUIT

HIGH PERFORMANCE CURRENT MODE CONTROLLERS

DESCRIPTION

The @vic AV3842B/3843B are specifically designed for Off-Line and dc-to-dc converter applications offering the designer a cost-effective solution with minimal external components.

The AV3842B has UVLO thresholds 16V (on) and 10V(off), ideally suited for off-line converters. The AV3843B is tailored for lower voltage applications having UVLO thresholds of 8.5V(on) and 7.6V(off).

FEATURES

- *Trimmed Oscillator for Precise Frequency Control
- *Oscillator Frequency Guaranteed at 250kHz
- *Current Mode Operation to 500kHz
- *Automatic Feed Forward Compensation
- *Latching PWM for Cycle-By-Cycle Current Limiting
- *Internally Trimmed Reference with Undervoltage Lockout
- *High Current Totem Pole Output
- *Undervoltage Lockout with Hysteresis
- *Low Startup and Operating Current

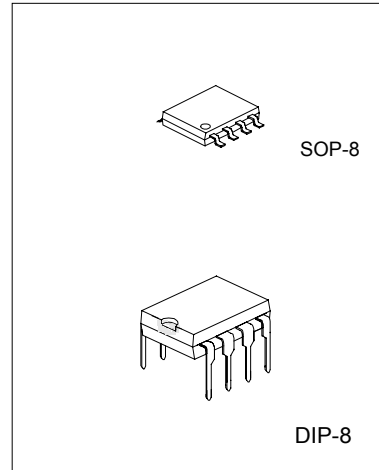

BLOCK DIAGRAM

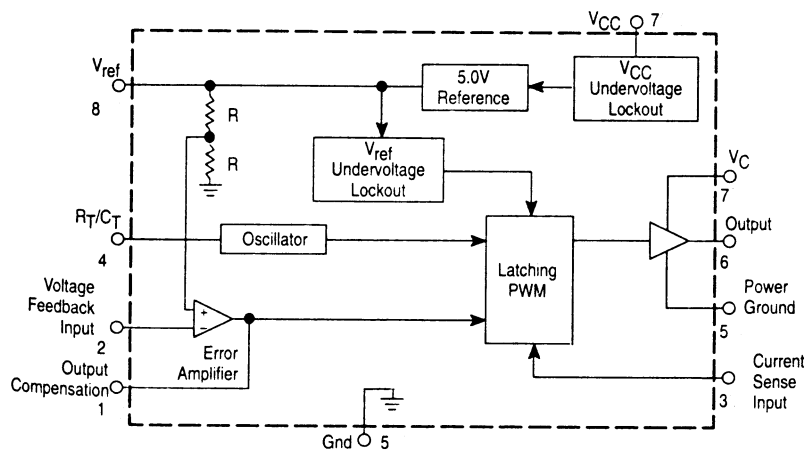

@vic AV3842B / 3843B LINEAR INTEGRATED CIRCUIT

ABSOLUTE MAXIMUM RATINGS(Ta=25°C)

PARAMETER	SYMBOL	VALUE	UNIT	
Total power supply and Zener current	(ICC + Iz)	30	mA	
Output current, source or sink (note1)	Io	1.0	A	
Output energy (capacitive load per cycle)	W	5.0	μJ	
Current sense and voltage feedback inputs	Vin	-0.3 ~ +5.5	V	
Error Amp. Output sink current	Io	10	mA	
Power dissipation and thermal characteristics	PD PθJA	DIP: 1250 DIP: 100	SOP: 702 SOP: 178	mW °C/W
Operating junction temperature	Tj	+150	°C	
Operating ambient temperature	TA	0 ~ +70	°C	
Storage temperature range	Tstg	-65 ~ +150	°C	

ELECTRICAL CHARACTERISTICS (0°C ≤ TA ≤ 70°C, VCC=15V [note 2], RT=10k, CT=3.3nF, unless otherwise specified)

PARAMETER	SYMBOL	TEST CONDITIONS	MIN	TYP	MAX	UNIT
Reference Section						
Output Voltage	VREF	Io=1.0mA, Tj=25°C	4.9	5.0	5.1	V
Line Regulation	Regline	VCC=12V to 25V		2.0	20	mV
Load Regulation	Regload	Io=1.0mA to 20mA		3.0	25	mV
Temperature Stability	Ts			0.2		mV/°C
Total Output Variation	Vref	Line, Load, Temperature	4.82		5.18	V
Output Noise Voltage	Vn	F=10kHz to 10Hz, Tj=25°C		50		μV
Long Term Stability	S	TA=125°C, 1000Hrs		5		mV
Output Short Circuit Current	Isc		-30	-85	-180	mA
Oscillator Section						
Frequency		Tj=25°C TA=0°C to 70°C Tj=25°C (RT=6.2k, CT=1.0nF)	49 48 225	52 250	55 56 275	kHz
Frequency Change with Voltage	Δfosc/ΔV	12 ≤ VCC ≤ 25V		0.2	1.0	%
Frequency Change with Temperature	Δfosc/ΔT	0°C ≤ TA ≤ 70°C		0.5		%
Oscillator Voltage Swing (Peak to Peak)	VOSC			1.6		V
Discharge Current	Idischg	Tj=25°C 0°C ≤ TA ≤ 70°C	7.8 7.6	8.3	8.8 8.8	mA
Error Amplifier Section						
Voltage Feedback Input	VFB	Vo=2.5V	2.42	2.50	2.58	V
Input Bias Current	IIB	VFB=5.0V		-0.1	-2.0	μA
Open Loop Voltage Gain	AVOL	2 ≤ Vo ≤ 4V	65	90		dB
Unity Gain Bandwidth	BW	Tj=25°C	0.7	1.0		MHz
Power Supply Rejection Ratio	PSRR	12V ≤ VCC ≤ 25V	60	70		dB
Output Sink Current	Isink	Vo=1.1V, VFB=2.7V	2.0	12		mA
Output Source Current	Isource	Vo=5.0V, VFB=2.3V	-0.5	-1.0		mA
Output Voltage Swing High State	VOH	VFB=2.3V, RL=15k to GND	5.0	6.2		V
Output Voltage Swing Low State	VOL	VFB=2.7V, RL=15k to Vref		0.8	1.1	V
Current Sense section						
Current Sense Input Voltage Gain	Av	(note 3,4)	2.85	3.0	3.15	V/V

@vic AV3842B / 3843B LINEAR INTEGRATED CIRCUIT

PARAMETER	SYMBOL	TEST CONDITIONS	MIN	TYP	MAX	UNIT
Maximum Current Sense Input Threshold	Vth	(note 3)	0.9	1.0	1.1	V
Power Supply Rejection Ratio	PSRR	12<=Vcc<=25V (note 3)		70		dB
Input Bias Current	IIB			-2	-10	μA
Propagation Delay	tPLH(In/Out)	Current Sense Input to Output		150	300	ns
Output Section						
Output Low Voltage	VOL	Isink=20mA		0.1	0.4	V
		Isink=200mA		1.6	2.2	V
Output High Level	VOH	Isource=20mA	13	13.5		V
		Isource=200mA	12	13.4		V
Output Voltage with UVLO Activated	VoL (UVLO)	Vcc=6.0V, Isink=1.0mA		0.1	1.1	V
Output Voltage Rise Time	tr	Tj=25°C, CL=1nF		50	150	ns
Output Voltage Fall Time	tf	Tj=25°C, CL=1nF		50	150	ns
Under-Voltage Lockout Section						
Startup Threshold	Vth	UTC UC3842B	14.5	16	17.5	V
		UTC UC3843B	7.8	8.4	9	V
Min. Operating Voltage After Turn-on(Vcc)	VCC(min)	UTC3842B	8.5	10	11.5	V
		UTC3843B	7.0	7.6	8.2	V
PWM Section						
Maximum Duty Cycle	DC(MAX)		94	96		%
Minimum Duty Cycle	DC(MIN)				0	%
Total Device						
Power Startup Supply Current	Icc+Ic	Vcc=6.5V for UC3843B Vcc=14V for UC3842B		0.3	0.5	mA
Power Operating Supply Current	Icc+Ic	Note2		12	17	mA
Power Supply Zener Voltage	Vz	Icc=25mA	30	36		V

Note 1: Maximum Package power dissipation limits must be observed.

Note 2: Adjust Vcc above the Startup threshold before setting to 15V.

Note 3: This parameter is measured at the latch trip point with VFB=0V.

Note 4: Comparator gain is defined as :

$$AV = \frac{\Delta V \text{ Output Compensation}}{\Delta V \text{ Current Sense Input}}$$

@vic AV3842B / 3843B LINEAR INTEGRATED CIRCUIT

TYPICAL PERFORMANCE CHARACTERISTICS

Figure 1. Timing Resistor versus Oscillator Frequency

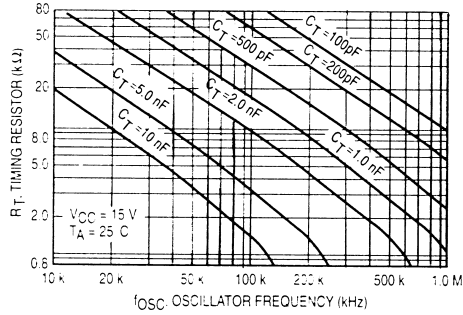

Figure 2. Output Deadtime versus Oscillator Frequency

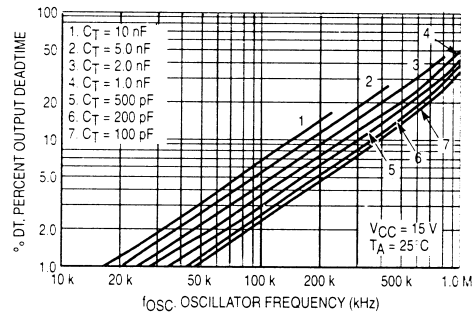

Figure 3. Oscillator Discharge Current versus Temperature

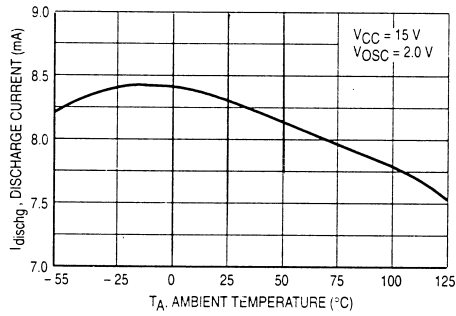
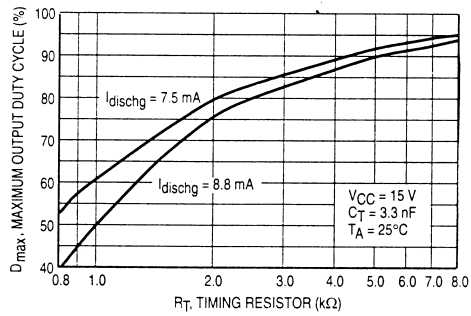

Figure 4. Maximum Output Duty Cycle versus Timing Resistor



@vic AV3842B / 3843B LINEAR INTEGRATED CIRCUIT

Figure 5. Error Amp Small Signal Transient Response

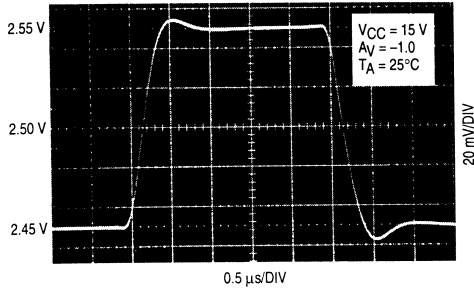

Figure 6. Error Amp Large Signal Transient Response

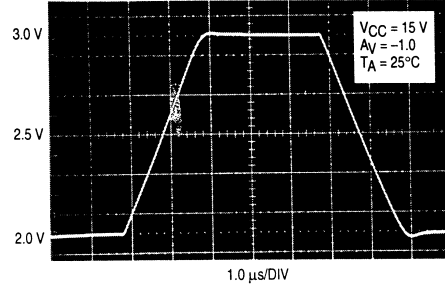

Figure 7. Error Amp Open Loop Gain and Phase versus Frequency

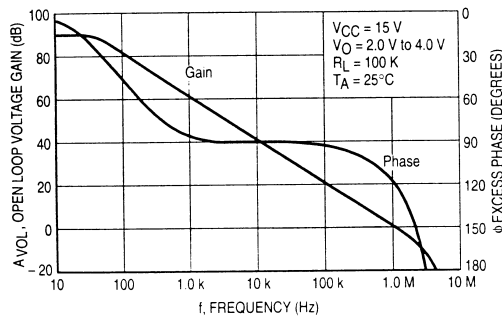

Figure 8. Current Sense Input Threshold versus Error Amp Output Voltage

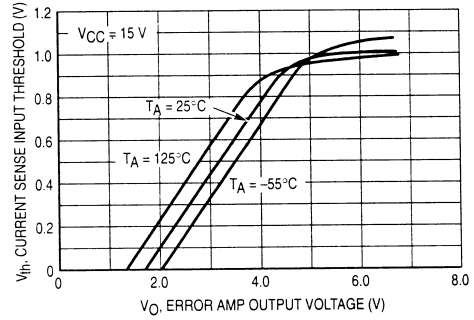

Figure 9. Reference Voltage Change versus Source Current

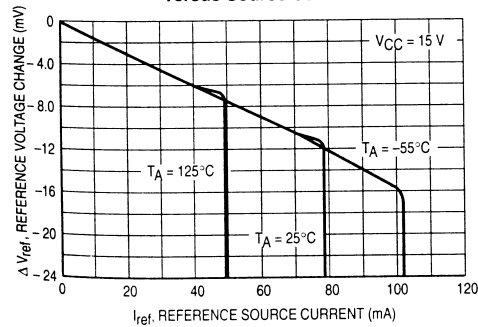

Figure 10. Reference Short Circuit Current versus Temperature

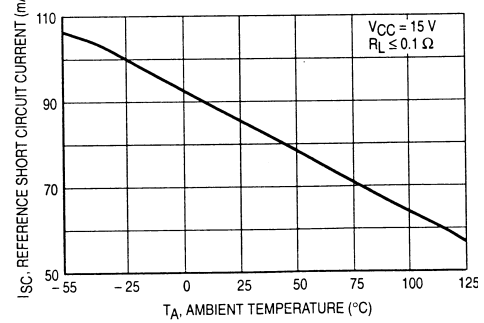

Figure 11. Reference Load Regulation

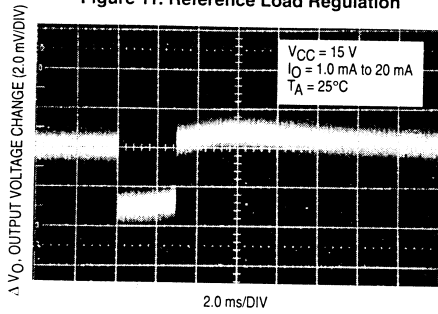

Figure 12. Reference Line Regulation

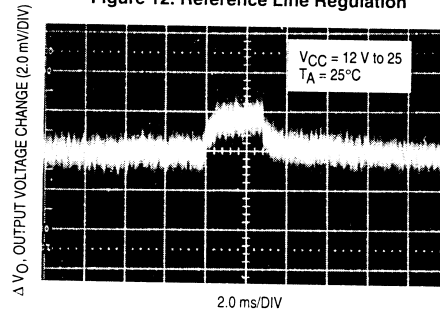

Figure 13. Output Saturation Voltage versus Load Current

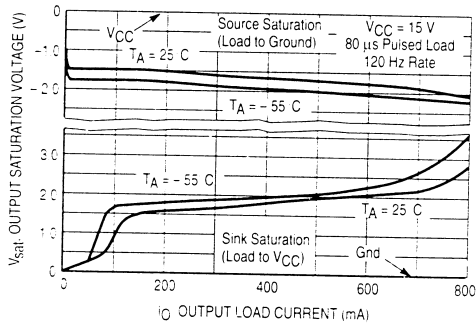

Figure 14. Output Waveform

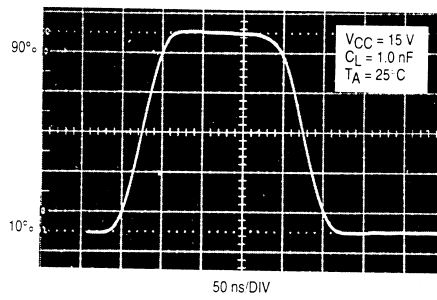

Figure 15. Output Cross Conduction

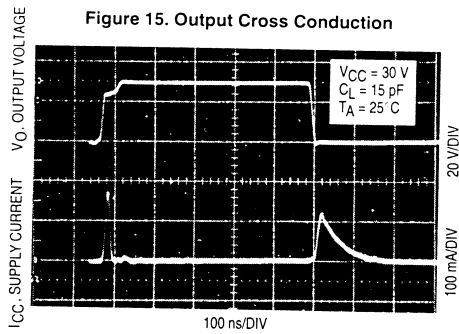

Figure 16. Supply Current versus Supply Voltage

