4.8 V NPN Silicon Bipolar Common Emitter Transistor

Technical Data

AT-38086

Features

- **4.8 Volt Pulsed**
(pulse width = 577 μ sec,
duty cycle = 12.5%)/CW
Operation
- **+28 dBm Pulsed P_{out}**
@ 900 MHz, Typ.
- **+23.5 dBm CW P_{out}**
@ 836.5 MHz, Typ.
- **60% Pulsed Collector**
Efficiency @ 900 MHz, Typ.
- **11 dB Pulsed Power Gain**
@ 900 MHz, Typ.
- **-35 dBc IMD_3 @ P_{out} of**
17 dBm per tone, 900 MHz,
Typ.

Applications

- **Driver Amplifier for GSM**
and AMPS/ETACS/ 900 MHz
NMT Cellular Phones
- **900 MHz ISM and Special**
Mobile Radio

85 mil Plastic Surface Mount Package Outline 86

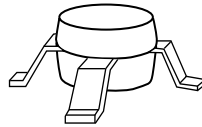

Pin Configuration

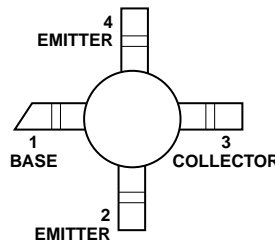

Description

Hewlett Packard's AT-38086 is a low cost, NPN silicon bipolar junction transistor housed in a surface mount plastic package. This device is designed for use as a pre-driver or driver device in applications for cellular and wireless communications markets. At 4.8 volts, the AT-38086 features +28 dBm pulsed output power, Class AB operation, and +23.5 dBm CW. Superior efficiency and gain makes the AT-38086 an excellent choice for battery powered systems.

The AT-38086 is fabricated with Hewlett Packard's 10 GHz F_t Self-Aligned-Transistor (SAT) process. The die are nitride passivated for surface protection. Excellent device uniformity, performance and reliability are produced by the use of ion-implantation, self-alignment techniques, and gold metalization in the fabrication of these devices.

AT-38086 Absolute Maximum Ratings

Symbol	Parameter	Units	Absolute Maximum ^[1]
V _{EBO}	Emitter-Base Voltage	V	1.4
V _{CBO}	Collector-Base Voltage	V	16.0
V _{CEO}	Collector-Emitter Voltage	V	9.5
I _C	Collector Current ^[2]	mA	250
I _C	Collector Current ^[3]	mA	160
P _T	Peak Power Dissipation ^[2, 4]	W	3.7
P _T	CW Power Dissipation ^[3, 5]	mW	460
T _j	Junction Temperature	°C	150
T _{STG}	Storage Temperature	°C	-65 to 150

Thermal Resistance^{[6]:}

$$\theta_{jc} = 140^{\circ}\text{C/W}$$

Notes:

1. Permanent damage may occur if any of these limits are exceeded.
2. Pulsed operation, pulse width = 577 μsec , duty cycle = 12.5%.
3. CW operation.
4. Derate at 57.1 mW/°C for T_C > 85 °C. T_C is defined to be the temperature of the collector pin 3, where the lead contacts the circuit board.
5. Derate at 7.1 mW/°C for T_C > 85 °C. T_C is defined to be the temperature of the collector pin 3, where the lead contacts the circuit board.
6. Using the liquid crystal technique, V_{CE} = 4.5 V, I_C = 50 mA, T_j = 150°C, 1-2 μm “hot-spot” resolution.

Electrical Specifications, T_C = 25°C

Symbol	Parameters and Test Conditions	Units	Min.	Typ.	Max.
	Freq. = 900 MHz, V _{CE} = 4.8 V, I _{CQ} = 20 mA, Pulse width = 577 μsec , duty cycle = 12.5%, unless otherwise specified				
P _{out}	Output Power, Pulsed Operation ^[1] Test Circuit A, P _{in} = +17 dBm	dBm	+26.5	+28.0	
η_c	Collector Efficiency, Pulsed Operation ^[1] Test Circuit A, P _{in} = +17 dBm	%	50	60	
	Mismatch Tolerance No Damage, Pulsed ^[1] Test Circuit A, P _{out} = +28 dBm, any phase, 2 sec duration				7:1
P _{out}	Output Power, CW Operation ^[2] F = 836.5 MHz, I _{CQ} = 15 mA Test Circuit B, P _{in} = +10 dBm	dBm	+22.0	+23.5	
IMD ₃	3rd Order Intermodulation Distortion, 2-Tone Test, P _{out} each tone = +17 dBm, CW ^[2,3] F1 = 899 MHz, F2 = 901 MHz I _{CQ} = 15 mA, Test Circuit B	dBc		-35	
	Mismatch Tolerance, No Damage, CW ^[2] F = 836.5 MHz, I _{CQ} = 15 mA Test Circuit B, P _{out} = +23.5 dBm any phase, 2 sec duration				7:1
BV _{EBO}	Emitter-Base Breakdown Voltage I _E = 0.2 mA, open collector	V	1.4		
BV _{CBO}	Collector-Base Breakdown Voltage I _C = 1.0 mA, open emitter	V	16.0		
BV _{CEO}	Collector-Emitter Breakdown Voltage I _C = 3.0 mA, open base	V	9.5		
h _{FE}	Forward Current Transfer Ratio V _{CE} = 3 V, I _C = 160 mA	—	40	150	330
I _{CEO}	Collector Leakage Current V _{CEO} = 5 V	μA			15

Notes:

1. With external matching on input and output, tested in a 50 ohm environment. Refer to Test Circuit A (GSM).
2. With external matching on input and output, tested in a 50 ohm environment. Refer to Test Circuit B (AMPS).
3. Test circuit B re-tuned at 900 MHz.

AT-38086 Typical Performance, $T_C = 25^\circ\text{C}$

Frequency = 900 MHz, $V_{CE} = 4.8\text{ V}$, $I_{CQ} = 20\text{ mA}$, pulsed operation, pulse width = 577 μsec , duty cycle = 12.5%, Test Circuit A (GSM), unless otherwise specified

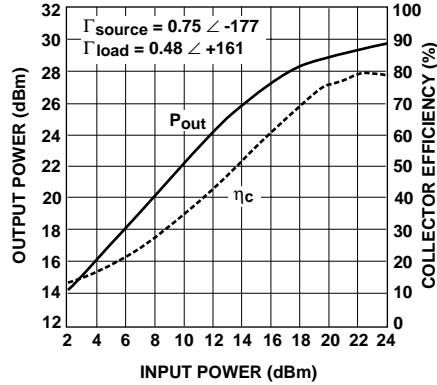

Figure 1. Output Power and Collector Efficiency vs. Input Power.

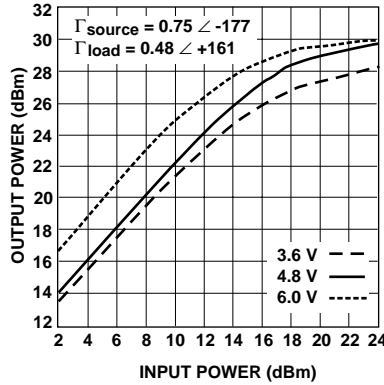

Figure 2. Output Power vs. Input Power Over Bias Voltage.

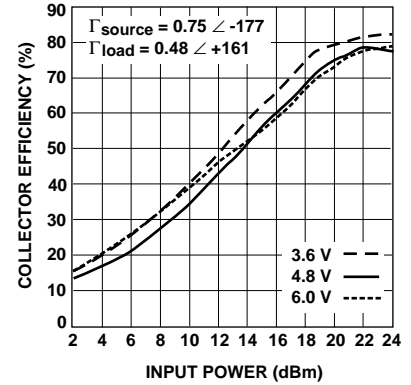

Figure 3. Collector Efficiency vs. Input Power Over Bias Voltage.

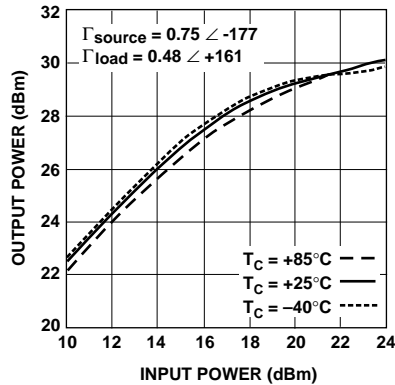

Figure 4. Output Power vs. Input Power Over Temperature.

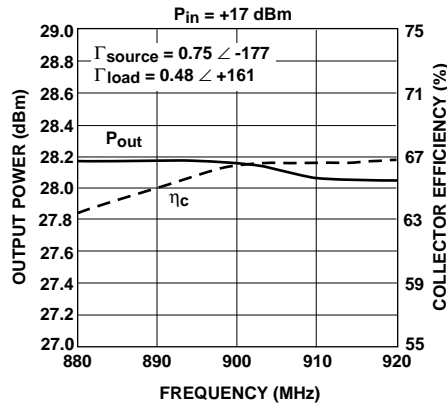

Figure 5. Output Power and Collector Efficiency vs. Frequency.
Note: Tuned at 900 MHz, then Swept over Frequency.

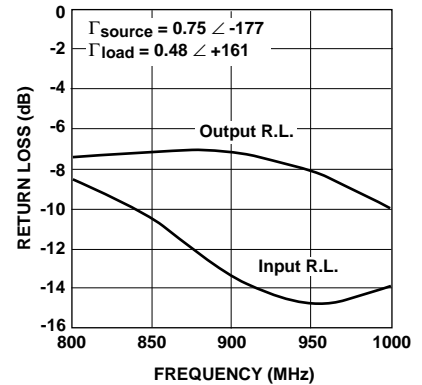

Figure 6. Input and Output Return Loss vs. Frequency.

AT-38086 Typical Performance, $T_C = 25^\circ\text{C}$

Freq. = 836.5 MHz, $V_{CE} = 4.8\text{ V}$, $I_{CQ} = 15\text{ mA}$, CW operation, Test Circuit B (AMPS), unless otherwise specified

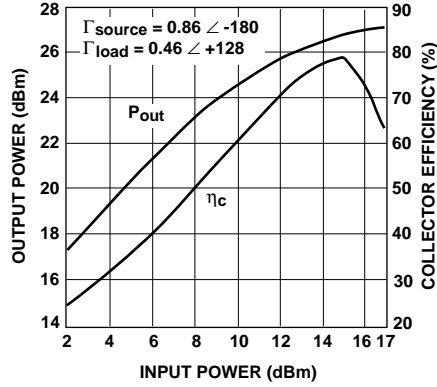

Figure 7. Output Power and Collector Efficiency vs. Input Power.

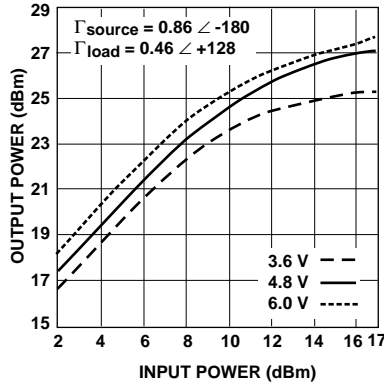

Figure 8. Output Power vs. Input Power Over Bias Voltage.

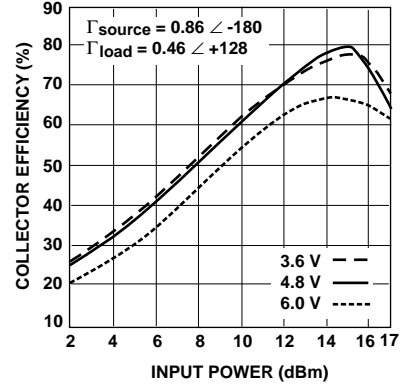

Figure 9. Collector Efficiency vs. Input Power Over Bias Voltage.

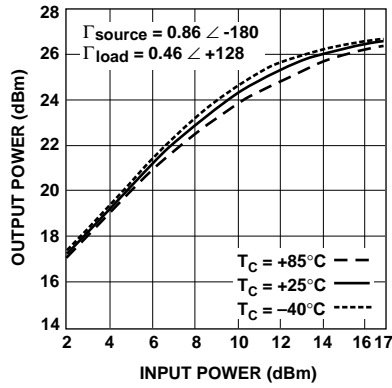

Figure 10. Output Power vs. Input Power Over Temperature.

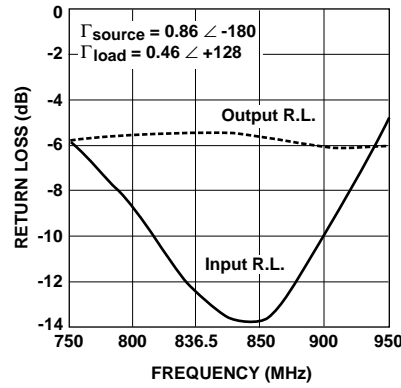

Figure 11. Input and Output Return Loss vs. Frequency.

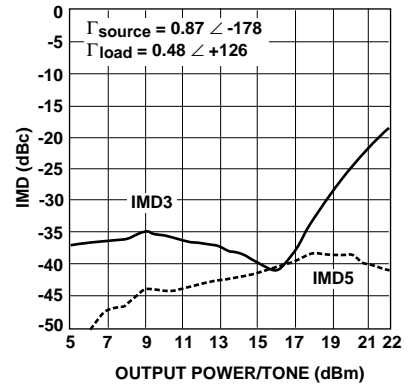

Figure 12. IMD3, IMD5 vs. Output Power Per Tone.
Note: Test circuit B (AMPS) used and re-tuned at 900 MHz.

AT-38086 Typical Large Signal Impedances (GSM)

Freq. = 900 MHz, $V_{CE} = 4.8$ V, $I_{CQ} = 20$ mA, Pulsed Operation, $P_{out} = +28.0$ dBm

Freq. MHz	Γ_{source}		Γ_{load}	
	Mag.	Ang.	Mag.	Ang.
880	0.743	-175.6	0.474	162.0
890	0.741	-176.4	0.476	161.5
900	0.747	-177.3	0.478	161.2
910	0.751	-178.1	0.481	160.0
915	0.752	-178.6	0.482	159.6
920	0.754	-179.1	0.483	158.9

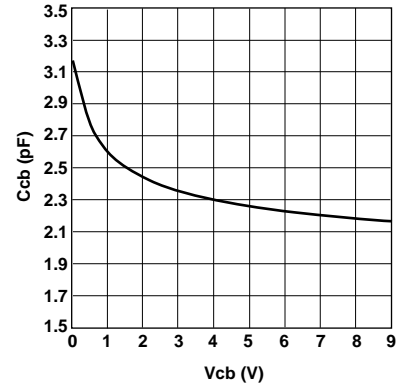

Figure 13. Collector-Base Capacitance vs. Collector-Base Voltage (DC Test).

AT-38086 Typical Large Signal Impedances (AMPS)

Freq. = 836.5 MHz, $V_{CE} = 4.8$ V, $I_{CQ} = 15$ mA, CW Operation, $P_{out} = +23.5$ dBm

Freq. MHz	Γ_{source}		Γ_{load}	
	Mag.	Ang.	Mag.	Ang.
824	0.856	-178.9	0.455	129.1
836.5	0.864	-179.9	0.459	128.2
849	0.870	-179.1	0.464	127.3

SPICE Model Parameters

Die Model

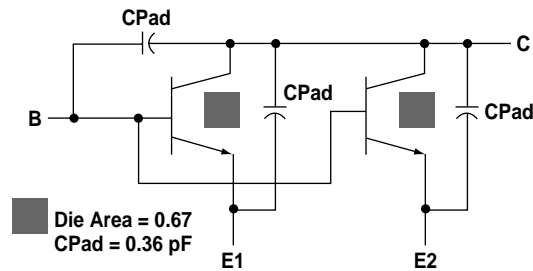

Label	Value	Label	Value
BF	280	NR	0.9886
IKF	299.9	TR	1E-9
ISE	9.9E-11	EG	1.11
NE	2.399	IS	3.598E-15
VAF	33.16	XTI	3
NF	0.9935	CJC	1.02 pF
TF	1.6E-11	VJC	0.4276
XTF	0.006656	MJC	0.2508
VTF	0.02785	XCJC	0.001
ITF	0.001	FC	0.999
PTF	23	CJE	0.98 pF
XTB	0	VJE	0.811
BR	54.61	MJE	0.596
IKR	81	RB	5.435
ISC	8.7E-13	RE	1.30
NC	1.587	RC	0.01
VAR	1.511		

Packaged Model

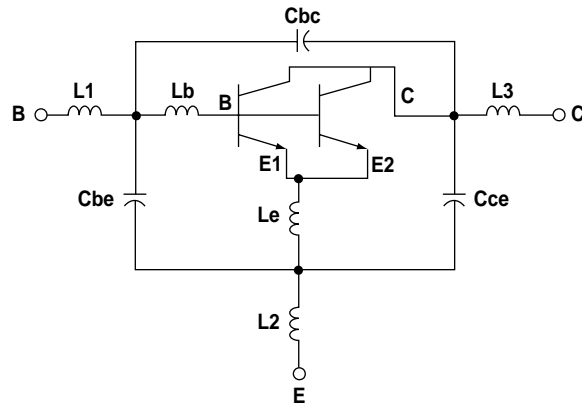

Label	Value
Cbe	0.032 pF
Cbc	0.036 pF
Cce	0.122 pF
L1	0.46 nH
L2	0.46 nH
L3	0.46 nH
Lb	0.47 nH
Le	0.14 nH

AT-38086 Typical Scattering Parameters, Common Emitter, $Z_0 = 50 \Omega$

$V_{CE} = 3.6 \text{ V}, I_c = 50 \text{ mA}, T_c = 25^\circ\text{C}$

Freq. GHz	S_{11}		dB	S_{21}		dB	S_{12}		S_{22}	
	Mag.	Ang.		Mag.	Ang.		Mag.	Ang.	Mag.	Ang.
0.05	0.71	-85	31.7	38.52	138	-31.7	0.026	54	0.75	-57
0.10	0.73	-124	28.2	25.72	118	-29.1	0.035	39	0.56	-90
0.25	0.75	-160	21.3	11.66	84	-27.3	0.043	35	0.39	-133
0.50	0.76	-176	15.5	5.95	76	-25.5	0.053	43	0.36	-155
0.75	0.76	175	12.0	3.98	72	-23.6	0.066	50	0.36	-165
0.90	0.77	171	10.4	3.32	69	-22.6	0.074	52	0.36	-168
1.00	0.77	169	9.5	2.99	63	-22.0	0.079	54	0.37	-170
1.25	0.78	164	7.6	2.39	57	-20.5	0.094	56	0.38	-174
1.50	0.78	160	6.0	1.99	51	-19.3	0.108	57	0.40	-176
1.75	0.79	156	4.7	1.71	46	-18.3	0.122	57	0.41	-179
2.00	0.80	152	3.5	1.49	41	-17.3	0.137	57	0.43	179
2.25	0.80	148	2.5	1.33	37	-16.4	0.151	57	0.45	176
2.50	0.81	145	1.5	1.19	32	-15.7	0.164	56	0.47	174
2.75	0.81	142	0.7	1.08	28	-15.0	0.178	55	0.49	172
3.00	0.82	139	-0.1	0.99	25	-14.4	0.191	54	0.51	169

$V_{CE} = 4.8 \text{ V}, I_c = 50 \text{ mA}, T_c = 25^\circ\text{C}$

0.05	0.72	-82	31.8	39.02	139	-31.7	0.026	54	0.76	-55
0.10	0.73	-121	28.4	26.32	119	-29.1	0.035	40	0.56	-87
0.25	0.75	-158	21.6	12.00	97	-27.3	0.043	35	0.38	-130
0.50	0.75	-176	15.8	6.14	85	-25.5	0.053	43	0.35	-154
0.75	0.76	176	12.3	4.10	76	-23.7	0.065	49	0.35	-163
0.90	0.76	172	10.7	3.42	72	-22.7	0.073	52	0.35	-167
1.00	0.76	169	9.8	3.08	69	-22.0	0.079	53	0.36	-169
1.25	0.77	164	7.8	2.46	63	-20.6	0.093	56	0.37	-172
1.50	0.78	160	6.2	2.05	57	-19.4	0.107	57	0.38	-175
1.75	0.78	156	4.9	1.76	51	-18.3	0.121	58	0.40	-178
2.00	0.79	152	3.8	1.54	46	-17.4	0.135	57	0.42	180
2.25	0.80	149	2.7	1.37	41	-16.5	0.150	57	0.44	177
2.50	0.80	145	1.8	1.23	37	-15.8	0.163	56	0.46	175
2.75	0.81	142	1.0	1.12	32	-15.0	0.177	55	0.48	173
3.00	0.82	139	0.2	1.02	28	-14.4	0.190	55	0.50	170

$V_{CE} = 6.0 \text{ V}, I_c = 50 \text{ mA}, T_c = 25^\circ\text{C}$

0.05	0.73	-79	31.8	39.07	140	-32.0	0.025	55	0.76	-54
0.10	0.74	-119	28.5	26.60	120	-29.1	0.035	40	0.56	-85
0.25	0.74	-157	21.7	12.21	98	-27.3	0.043	35	0.38	-128
0.50	0.75	-175	15.9	6.25	85	-25.5	0.053	42	0.34	-152
0.75	0.75	176	12.4	4.18	76	-23.7	0.065	49	0.34	-162
0.90	0.76	172	10.8	3.48	72	-22.7	0.073	52	0.34	-166
1.00	0.76	170	9.9	3.13	69	-22.2	0.078	53	0.34	-167
1.25	0.77	165	8.0	2.51	63	-20.7	0.092	56	0.36	-171
1.50	0.77	160	6.4	2.09	57	-19.5	0.106	57	0.37	-174
1.75	0.78	156	5.1	1.79	51	-18.4	0.120	57	0.39	-177
2.00	0.79	152	3.9	1.56	46	-17.5	0.134	58	0.41	-179
2.25	0.79	149	2.9	1.39	41	-16.6	0.148	57	0.43	178
2.50	0.80	146	1.9	1.25	37	-15.8	0.162	56	0.45	176
2.75	0.81	142	1.1	1.13	32	-15.1	0.175	56	0.47	174
3.00	0.81	139	0.3	1.03	28	-14.5	0.188	55	0.49	171

Typical Performance

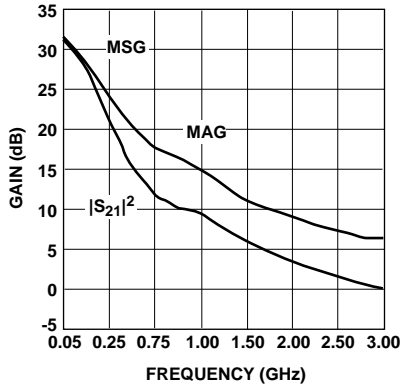

Figure 14. Insertion Power Gain, Maximum Available Gain, and Maximum Stable Gain vs. Frequency. $V_{CE} = 3.6V$, $I_C = 50$ mA.

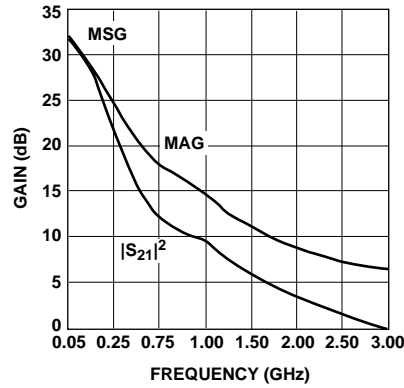

Figure 15. Insertion Power Gain, Maximum Available Gain, and Maximum Stable Gain vs. Frequency. $V_{CE} = 4.8V$, $I_C = 50$ mA.

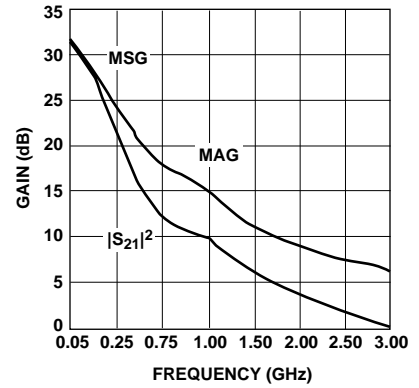

Figure 16. Insertion Power Gain, Maximum Available Gain, and Maximum Stable Gain vs. Frequency. $V_{CE} = 6.0V$, $I_C = 50$ mA.

Part Number Ordering Information

Part Number	No. of Devices	Container
AT-38086-TR1	1000	7" Reel
AT-38086-BLK	100	Antistatic Bag

Package Dimensions

Outline 86

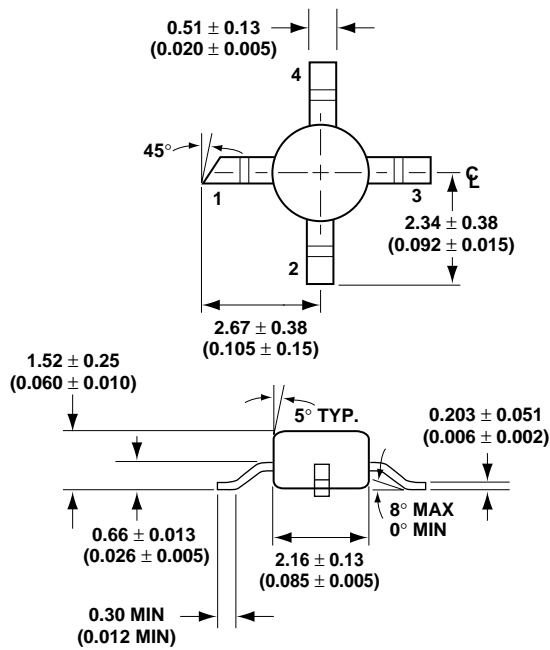

DIMENSIONS ARE IN MILLIMETERS (INCHES)

Test Circuit A: Test Circuit Board Layout @ 900 MHz for Pulsed Operation (GSM)

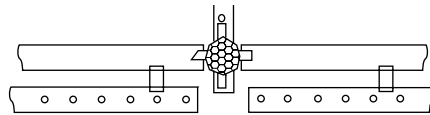
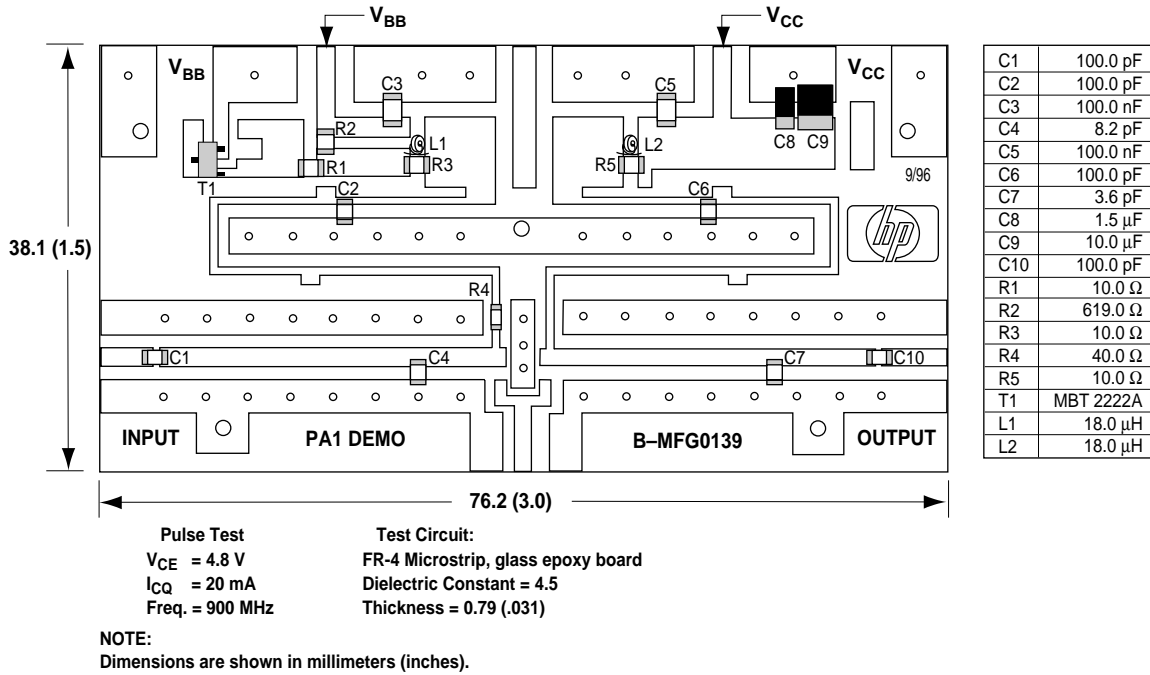

Test Circuit A: Test Circuit Schematic Diagram @ 900 MHz for Pulsed Operation (GSM)

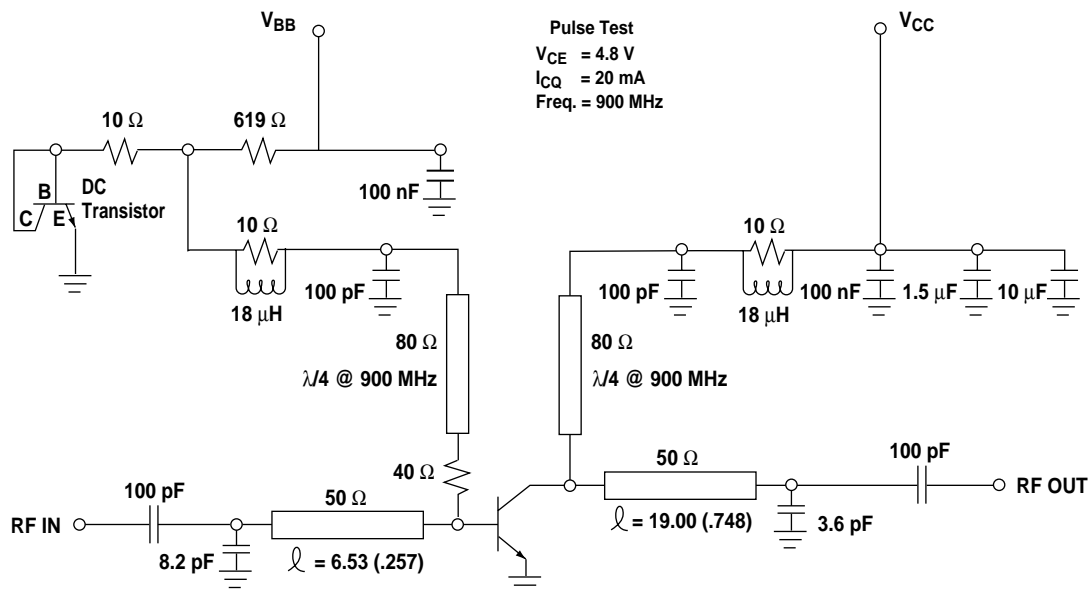

Test Circuit B: Test Circuit Board Layout @ 836.5 MHz for CW Operation (AMPS)

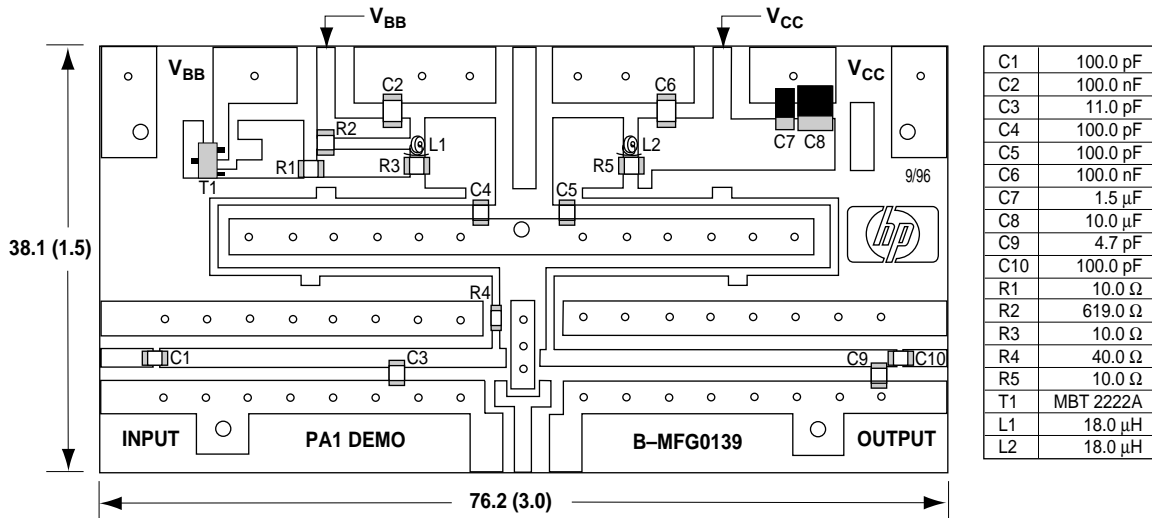

CW Test
 $V_{CE} = 4.8$ V
 $I_{CQ} = 15$ mA
 Freq. = 836.5 MHz

Test Circuit:
 FR-4 Microstrip, glass epoxy board
 Dielectric Constant = 4.5
 Thickness = 0.79 (.031)

NOTE:
 Dimensions are shown in millimeters (inches).

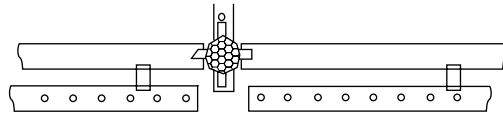

Test Circuit B: Test Circuit Schematic Diagram @ 836.5 MHz for CW Operation (AMPS)

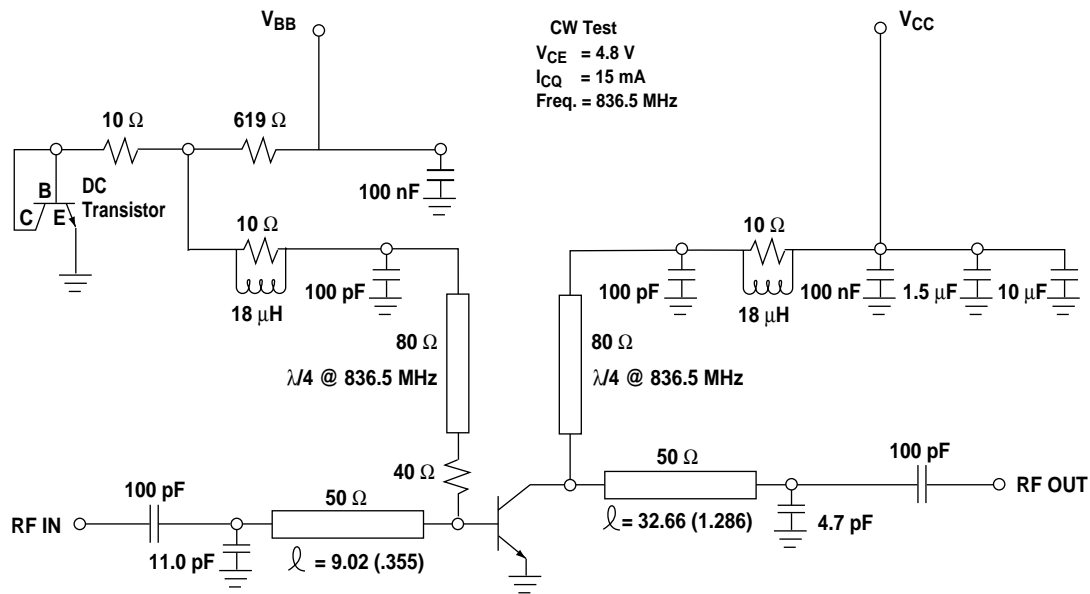

Tape Dimensions and Product Orientation for Outline 86

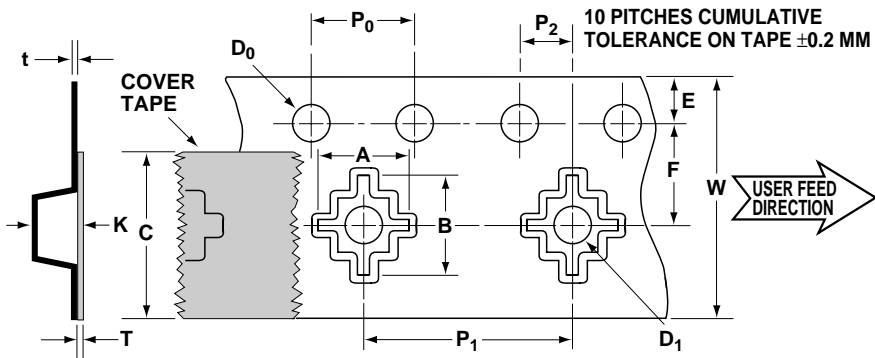
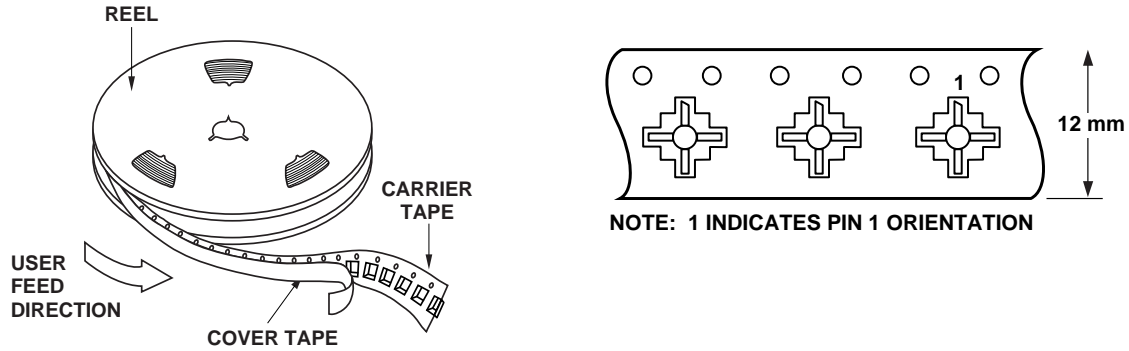

DESCRIPTION		SYMBOL	SIZE (mm)	SIZE (INCHES)
CAVITY	LENGTH	A	5.77 ± 0.10	0.227 ± 0.004
	WIDTH	B	6.10 ± 0.10	0.240 ± 0.004
	DEPTH	K	1.70 ± 0.10	0.067 ± 0.004
	PITCH	P_1	8.00 ± 0.10	0.314 ± 0.004
	BOTTOM HOLE DIAMETER	D_1	1.50 min.	0.059 min.
PERFORATION	DIAMETER	D_0	$1.50 + 0.10/-0.05$	$0.059 + 0.004/-0.002$
	PITCH	P_0	4.00 ± 0.10	0.157 ± 0.004
	POSITION	E	1.75 ± 0.10	0.069 ± 0.004
CARRIER TAPE	WIDTH	W	12.00 ± 0.20	0.472 ± 0.008
	THICKNESS	t	0.30 ± 0.05	0.012 ± 0.002
COVER TAPE	WIDTH	C	9.30 ± 0.10	0.366 ± 0.004
	TAPE THICKNESS	T	0.065 ± 0.010	0.0026 ± 0.0004
DISTANCE BETWEEN CENTERLINE	CAVITY TO PERFORATION (WIDTH DIRECTION)	F	5.50 ± 0.05	0.217 ± 0.002
	CAVITY TO PERFORATION (LENGTH DIRECTION)	P_2	2.00 ± 0.05	0.079 ± 0.002