

FEATURES

- Photo Mos Relay and Optocoupler in One Package
- Package - Single 8 Pin SO
- I/O Isolation, 1500 V_{RMS}
- Surface Mount Option
- Optocoupler
 - Bi-directional Current Detection
- Mos Relay
 - Typical R_{ON} 20Ω
 - Load Voltage 400 V
 - Load Current 130 mA
 - High Surge Capability
 - Linear, AC/DC Operation
 - Clean Bounce Free Switching
 - Low Power Consumption
 - High Reliability Monolithic Receptor
- Applications
 - Telecommunications
 - Telecom Switching
 - Tip/Ring Circuits
 - Modem Switching (Laptop, Notebook, Pocket Size)
 - Hookswitch
 - Dial Pulsing
 - Ground Start
 - Ringer Injection
 - Loop Detect
 - Ring Detect

DESCRIPTION

The AQW210TS Telecom switch consists of an optically coupled Photo Mos Relay and a bi-directional input optocoupler. The Relay is ideal for performing switchhook and dial-pulse switching while the optocoupler performs ring detection and loop current sensing functions. Both the Relay and opto coupler provide 1500 V_{RMS} of input to output isolation.

The Relay uses high voltage DMOS technology. The Relay features low ON-resistance, high breakdown voltage that protects the relay from telephone line induced lightning surges.

The optocoupler provides bi-directional current sensing via two antiparallel GaAs infrared emitting diodes. The opto channel provides a minimum CTR of 30% at ±1 mA.

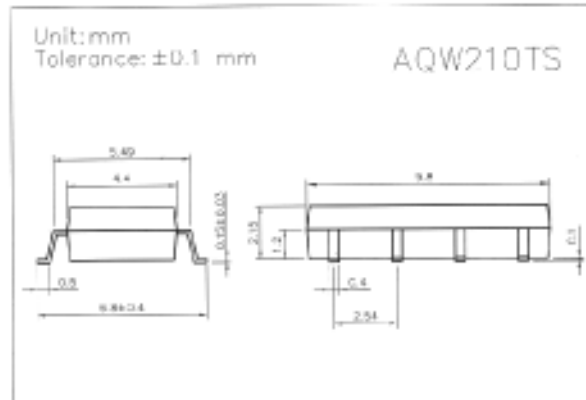

Absolute Maximum Ratings (T_A = 25°C)

Emitter (Input)

Reverse Voltage.....	5.0V
Continuous Forward Current.....	50mA
Peak Forward Current (1s).....	1A
Power Dissipation.....	100mW
Derate Linearly from 25°C.....	1.3mW/°C

Detector (Output)

Output Breakdown Voltage.....	±350V
Continuous Load Current.....	±130mA
Power Dissipation.....	500mW

General Characteristics

Isolation Test Voltage.....	1500VAC _{RMS}
Isolation Resistance	
V _{IO} = 500V, T _A = 25°C.....	≥10 ¹⁰ Ω
Total Power Dissipation.....	550mW
Derate Linearly from 25°C.....	2.5mW/°C
Storage Temperature Range.....	-40 to +150°C
Operating Temperature Range.....	-40 to +85°C
Junction Temperature.....	100°C
Soldering Temperature, 2mm from case, 10 sec... ..	260°C

- Turn on/Turn off Time
Relay

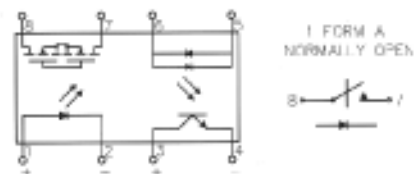

Characteristics

(T_A = 25°C)

Description	Symbol	Min.	Typ.	Max.	Unit	Test Condition
Emitter (Input)						
Forward Voltage	V _F		1.8	2.0	V	I _F = 10 mA
Operation Input Current	I _{FON}			5	mA	V _L = ± 20 V, I _L = 100 mA, t = 10 ms
Recovery Input Current	I _{FOFF}	0.2			mA	V _L = ± 20 V, I _L = < 5 μA
Detector (output)						
Output Breakdown Voltage	V _B	400			V	I _B = 50 μA
Output Off-State Leakage	I _{T(OFF)}		0.2	1	μA	V _T = 100 V, I _F = 0 mA
I/O Capacitance	C _{ISO}		6		pF	I _F = 0, f = 1 MHz
ON Resistance	R _{ON}		20	30	Ω	I _L = 100 mA, I _F = 10 mA
Turn-on Time	T _{ON}		0.3	1.0	ms	I _F = 10 mA, V _L = ± 20 V
Turn-off Time	T _{OFF}		0.7	1.5	ms	t = 10 ms, I _F = ± 100 mA

DATA CURVE

Load current vs. ambient temperature
 Allowable ambient temperature:
 -40°C to + 85°C

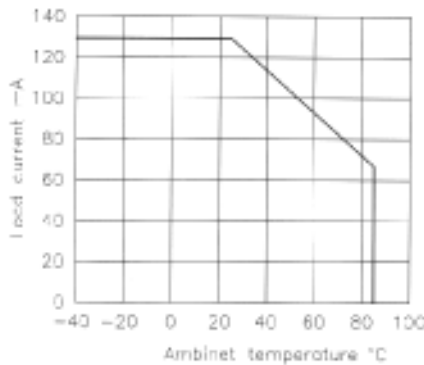

On resistance vs. ambient temperature
 Across terminals 7 and 8 pin
 LED current: 5 mA
 Continuous load current: 130 mA(DC)

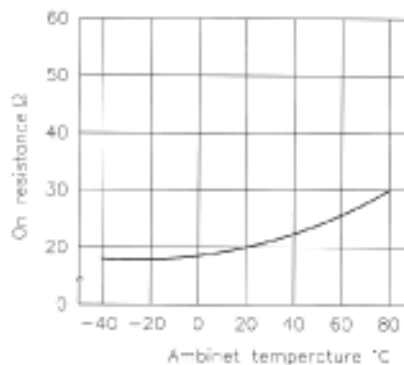

Turn on time vs. ambient temperature
 Load voltage 400 V(DC)
 LED current : 5 mA
 Continuous load current: 130 mA(DC)

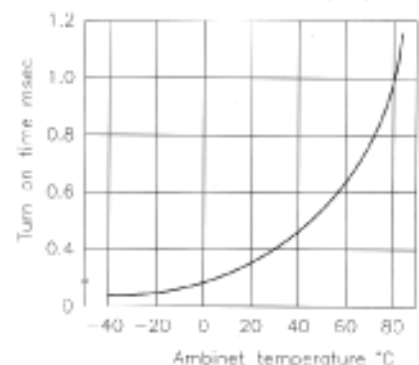

Turn off time vs. ambient temperature
 LED current: 5 mA
 Load voltage: 400 V(DC)
 Continuous load current: 130 mA(DC)

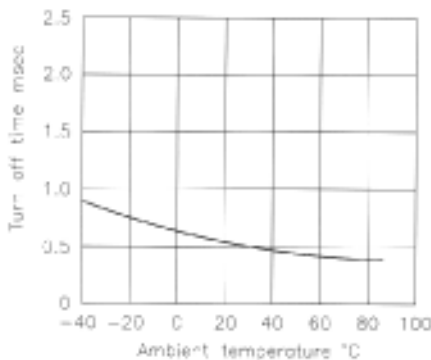

LED operate vs. ambient temperature
 Load voltage: 400 V (DC)
 Continuous load current: 130 mA(DC)

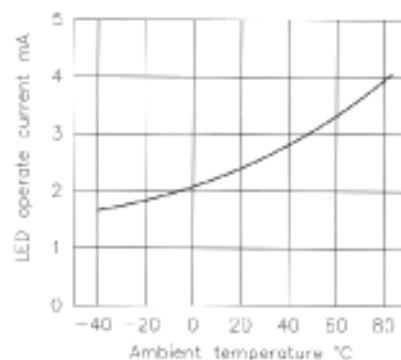

LED turn off current vs. ambient temperature;
 Load voltage: 400 V (DC)
 Continuous load current: 130 mA(DC)

