

Features

- **±1.5% LED Current Matching**
- **High Efficiency Up to 90% Over Li-ion Battery Discharge**
- **Output Current Up to 30mA per LED**
- **2.7V to 5.5V Operating Voltage**
- **Allow to Turn On or Off a Combination of LEDs**
- **1x/1.5x/2x Charge Pump Modes**
- **Low Shutdown Current: 2mA Maximum**
- **Low Input Ripple and EMI**
- **Internal Soft-Start Limits Inrush Current**
- **Short Circuit Current-Limit**
- **Thermal Shutdown Protection**
- **Output Over-Voltage Protection**
- **3mmx3mm 16-Pin QFN (QFN3X3-16) Package**
- **Lead Free and Green Devices Available (RoHS Compliant)**

Applications

- **Cellular Phone White LED Back Light**
- **Portable Device**
- **PDA and Handheld Computer**
- **DSC**

General Description

The APW7008 is a high efficiency charge pump white LED driver; the device drives up four white LEDs with regulated constant current for uniform intensity. The supply voltage ranges from 2.7V to 5.5V and it is optimized for a Li-ion battery application. The APW7008 operates in 1x, 1.5x, and 2x charge pump modes and automatically switches the charge pump modes depend on the input voltage to maintain the required power for high power efficiency. The APW7008 provides up to 30mA per LED for a total of 120mA and allows several methods, such as a PWM signal on the CTRL0 pin for LED dimming. Three control logic pins allow to disable or enable a combination of LEDs. The supply current is only 2mA in 2x mode, and the EN pin allows the device to enter shutdown mode with 2µA quiescent current. The APW7008 switches at 1MHz frequency and only requires four 1µF ceramic capacitors and one resistor, and ensures low input current ripple and EMI.

The APW7008 is available in a 16-pin QFN package.

Pin Configuration

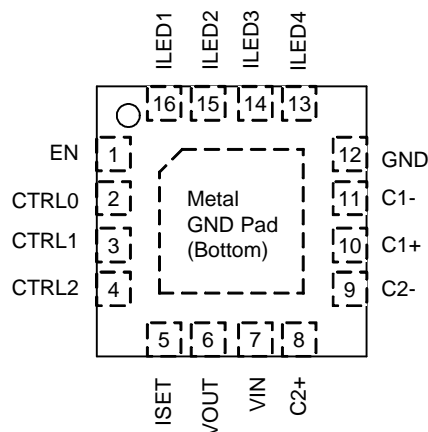

APW7008

QFN3x3-16 Top View

ANPEC reserves the right to make changes to improve reliability or manufacturability without notice, and advise customers to obtain the latest version of relevant information to verify before placing orders.

Ordering and Marking Information

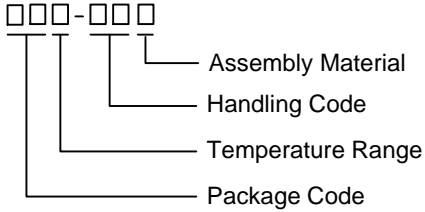
<p>APW7008 □□□-□□□</p>  <p> Assembly Material Handling Code Temperature Range Package Code </p>	<p> Package Code QA : QFN3x3-16 Operating Ambient Temperature Range I : -40 to 85 °C Handling Code TR : Tape & Reel Assembly Material G : Halogen and Lead Free Device </p>	
<p>APW7008 QA :</p> <table border="1" style="display: inline-table; margin-left: 20px;"> <tr> <td style="padding: 2px;"> APW 7008 XXXXX </td> </tr> </table>	APW 7008 XXXXX	<p>XXXXX - Date Code</p>
APW 7008 XXXXX		

Note : ANPEC lead-free products contain molding compounds/die attach materials and 100% matte tin plate termination finish; which are fully compliant with RoHS. ANPEC lead-free products meet or exceed the lead-free requirements of IPC/JEDEC J-STD-020C for MSL classification at lead-free peak reflow temperature. ANPEC defines "Green" to mean lead-free (RoHS compliant) and halogen free (Br or Cl does not exceed 900ppm by weight in homogeneous material and total of Br and Cl does not exceed 1500ppm by weight).

Absolute Maximum Ratings (Note 1, 2)

Symbol	Parameter	Rating	Unit
V _{OUT}	V _{OUT} to GND	-0.3 to +6	V
V _{IN}	V _{IN} to GND	-0.3 to +6	V
V _{C1+} , V _{C1-} , V _{C2+} , V _{C2-}	C1+, C1-, C2+, C2- to GND	-0.3 to +6	V
V _{ILED1-4}	I _{LED1-4} to GND	-0.3 to +6	V
V _{CTRL0/1/2} , V _{EN}	CTRL0/1/2, EN to GND	-0.3 to +6	V
V _{ISET}	I _{SET} to GND	-0.3 to 2	V
T _J	Maximum Junction Temperature	+150	°C
T _{STG}	Storage Temperature	-65 ~ 150	°C
T _{SDR}	Maximum Lead Soldering Temperature, 10 Seconds	260	°C

Note 1: Stresses beyond the absolute maximum rating may damage the device and operating in the absolute maximum rating conditions for extended periods may affect device reliability.

Note 2: The maximum allowable power dissipation at any T_A (ambient temperature) is calculated using: PD(max) = (T_J - T_A) / θ_{JA}; T_J=125°C. Exceeding the maximum allowable power dissipation will result in excessive die temperature.

Thermal Characteristics

Symbol	Parameter	Typical Value	Unit
R _{θJA}	Thermal Resistance – Junction to Ambient	40	°C/W

Recommended Operating Conditions

Symbol	Parameter	Rating	Unit
V _{IN}	Input Voltage	2.8 to 4.5	V
V _{OUT}	Output Voltage	3 to 4	V
I _{LED}	LED Current	5 to 30	mA
I _{OUT}	Output Current, V _{IN} >3.5V, V _F =3.1V, 1x Mode	180	mA
	Output Current, 3.5V<V _{IN} >3.1V, V _F =3.1V, 1.5x Mode	120	
	Output Current, 3.1V<V _{IN} >2.8V, V _F =3.1V, 2x Mode	90	
T _A	Ambient Temperature	-40 to 85	°C

Electrical Characteristics

V_{IN} = 2.85 to 5.5V, C_{IN} = C_{OUT} = C1 = C2 = 1μF (ESR = 0.03Ω), I_{LED} = 20mA, T_A = -40°C to +85°C, unless otherwise noted. Typical values are at T_A = +25°C.

Symbol	Parameter	Test Conditions	APW7008			Unit
			Min.	Typ.	Max.	
V _{IN}	Input Voltage		2.7	-	5.5	V
V _{UVLO}	Under-Voltage Lockout Threshold	V _{IN} falling	2.2	2.4	2.6	V
	Under-Voltage Lockout Hysteresis		-	50	-	mV
I _Q	Quiescent Current	in 1.5x/2x mode	-	2	4	mA
		No switching in 1x mode	-	0.5	1	mA
		EN=0	-	0.1	2	μA
I _{LED-ERR}	LED Current Accuracy	5mA<I _{LED} <30mA (Note 3)	-	±2	±8	%
	Current Matching	5mA<I _{LED} <30mA (Note 4)	-	±1.5	±5	%
I _{ISET}	ISET Current		5	-	1000	μA
	ISET to LED Current Ratio	I _{ILED} / (1.2V / R _{EST}) 5mA<I _{LED} <30mA, T _A = +25°C	370	400	420	
V _{ILED-TH}	ILED Threshold Voltage	V _{ILED} falling	-	100	-	mV
	1.5x mode to 1x mode Transition Hysteresis	V _{IN} rising, V _{IN} -V _{OUT}	-	300	-	mV
	2x mode to 1.5x mode Transition Hysteresis	V _{IN} rising, V _{OUT} -V _{IN}	-	300	-	mV
F _{OSC}	Switching Frequency		0.8	1	1.2	MHz
R _{OUT}	Open Loop VOUT Resistance	1x mode (V _{IN} -V _{OUT}) / I _{OUT}	-	1.6	3	Ω
		1.5x mode (1.5xV _{IN} -V _{OUT}) / I _{OUT}	-	7	12	
		2x mode (2xV _{IN} -V _{OUT}) / I _{OUT}	-	16	28	
I _{SHORT}	Short Circuit Current-Limit	V _{OUT} < 1V	-	40	-	mA
V _{OVP}	OVP Threshold		5	5.5	6	
V _{IH}	Logic Pins High Threshold		1.3	0.7	-	V

Electrical Characteristics (Cont.)

$V_{IN} = 2.85$ to $5.5V$, $C_{IN} = C_{OUT} = C1 = C2 = 1\mu F$ (ESR = 0.03Ω), $I_{LED} = 20mA$, $T_A = -40^\circ C$ to $+85^\circ C$, unless otherwise noted. Typical values are at $T_A = +25^\circ C$.

Symbol	Parameter	Test Conditions	APW7008			Unit
			Min.	Typ.	Max.	
V_{IL}	Logic Pins Low Threshold		-	0.6	0.3	V
I_{IH}	Logic Pins High Current	$V_{IH} = V_{IN}$	-	-	1	μA
I_{IL}	Logic Pins Low Current	$V_{IL} = GND$	-	-	1	μA
	Thermal Shutdown		-	150	-	$^\circ C$
	Thermal Shutdown Hysteresis		-	20	-	$^\circ C$

Note 3: LED current accuracy is defined as: $\pm (ILED-MEASURED - ILED-SET) / ILED-SET$

Note 4: LED current matching is defined as: $\pm (ILED-MAX - ILED-MIN) / (ILED-MAX + ILED-MIN)$

Typical Operating Characteristics

Efficiency vs. Input Voltage

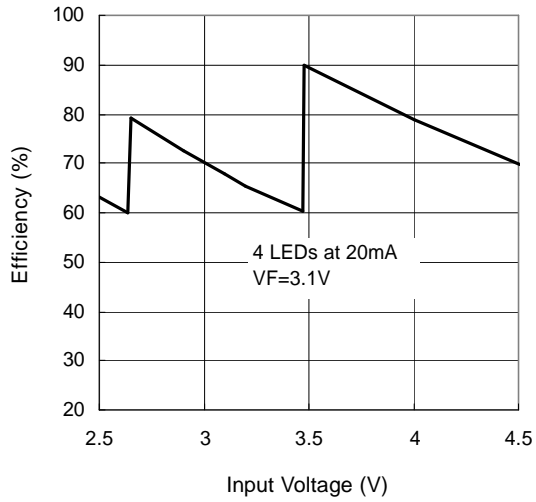

Efficiency vs. Input Voltage

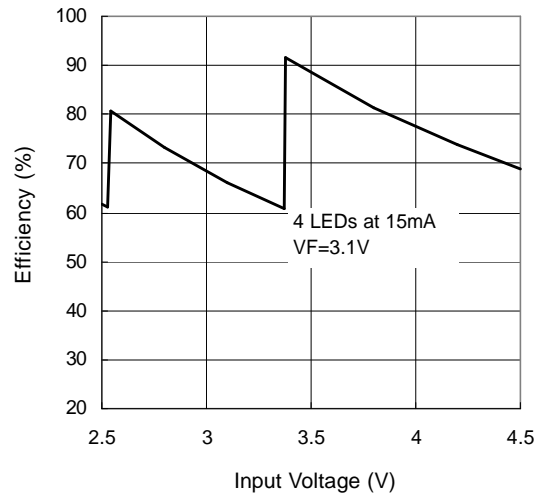

Efficiency vs. Input Voltage

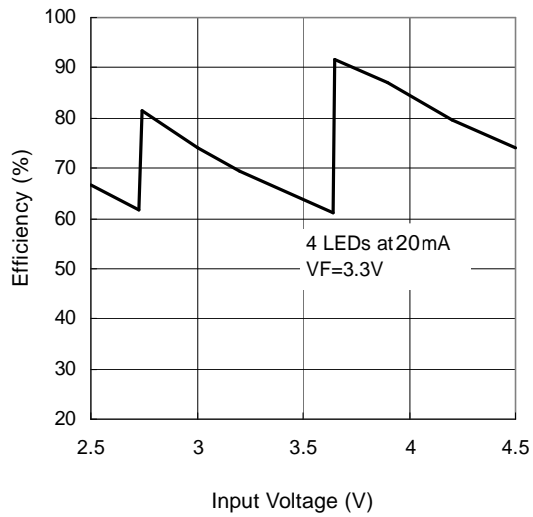

Efficiency vs. Input Voltage

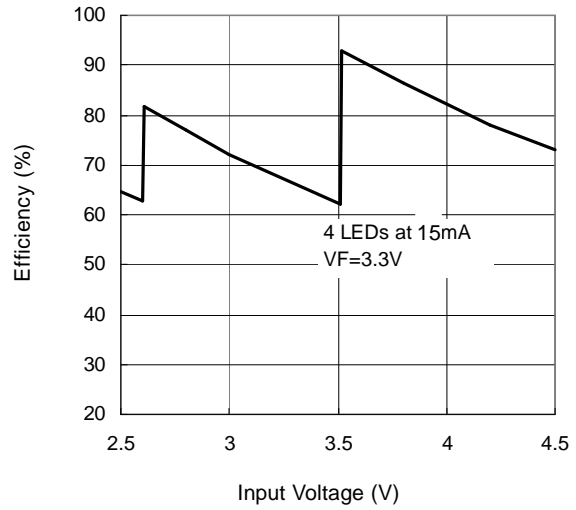

Typical Operating Characteristics (Cont.)

Input Current vs. Input Voltage

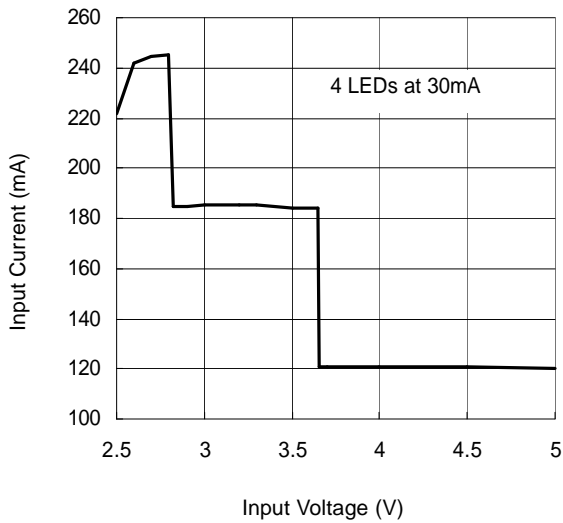

Input Current vs. Input Voltage

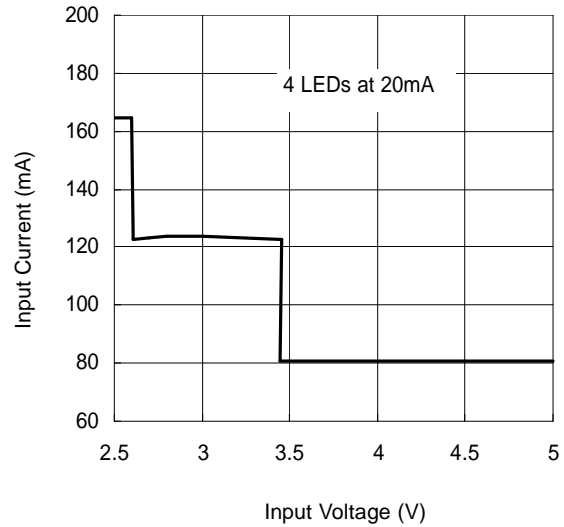

LED Current vs. Input Voltage

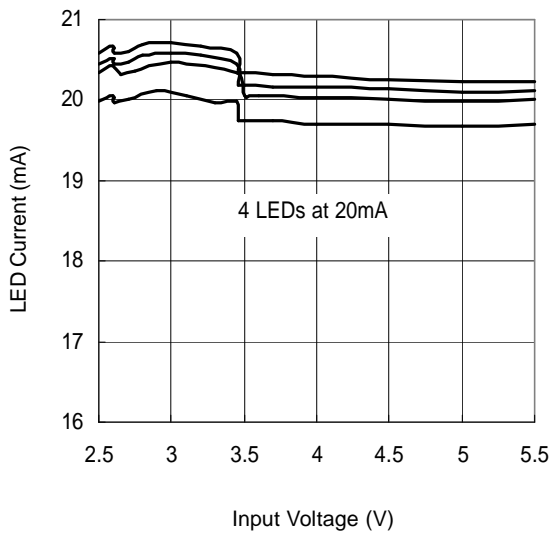

LED Current vs. Input Voltage

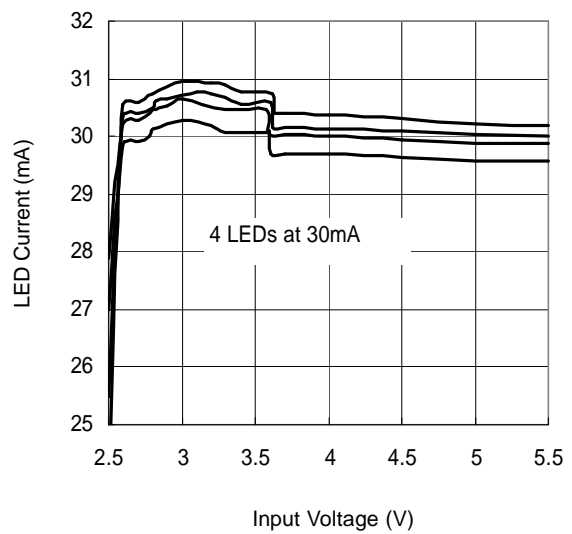

Typical Operating Characteristics (Cont.)

Logic Threshold Voltage vs. Input Voltage

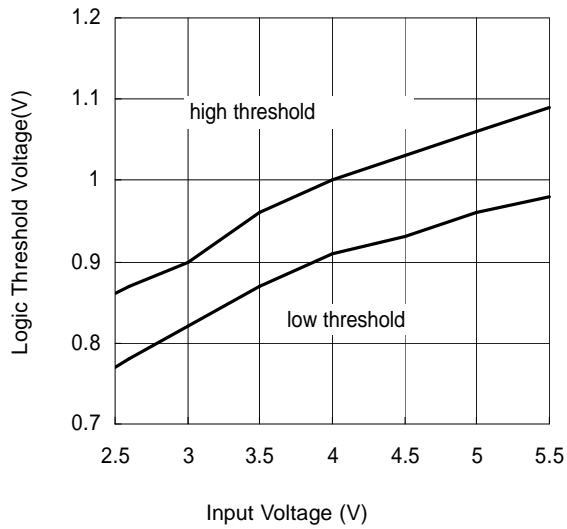

Switching Frequency vs. Input Voltage

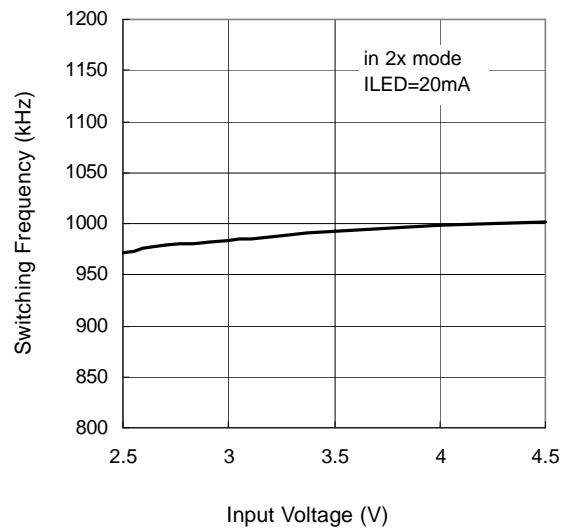

Switching Frequency vs. Temperature

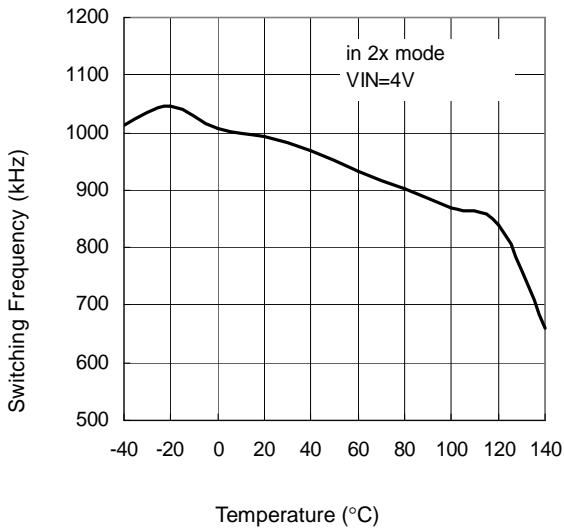

LED Current vs. Temperature

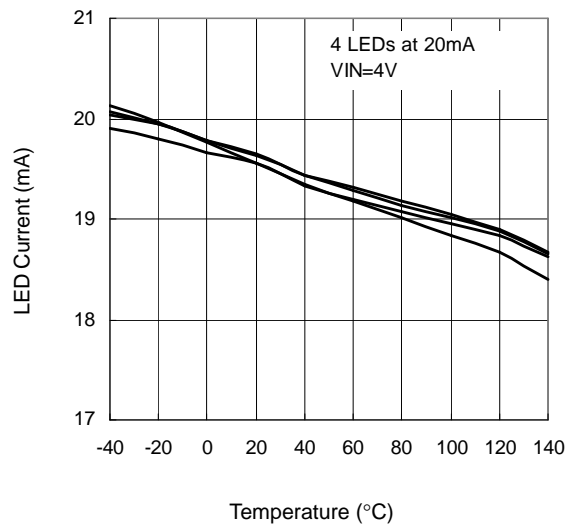

Typical Operating Characteristics (Cont.)

LED Current vs. Temperature

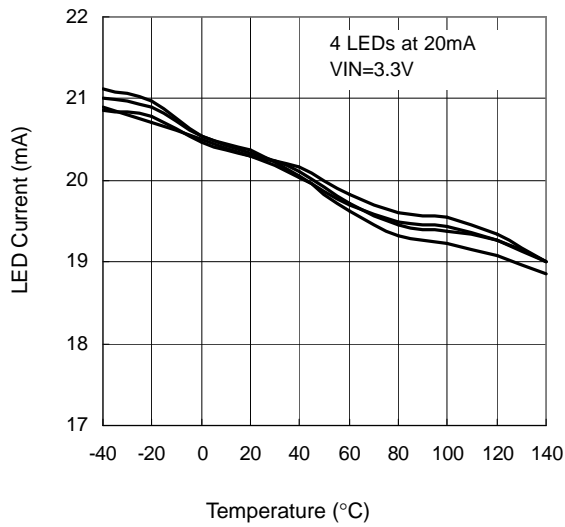

LED Current vs. Temperature

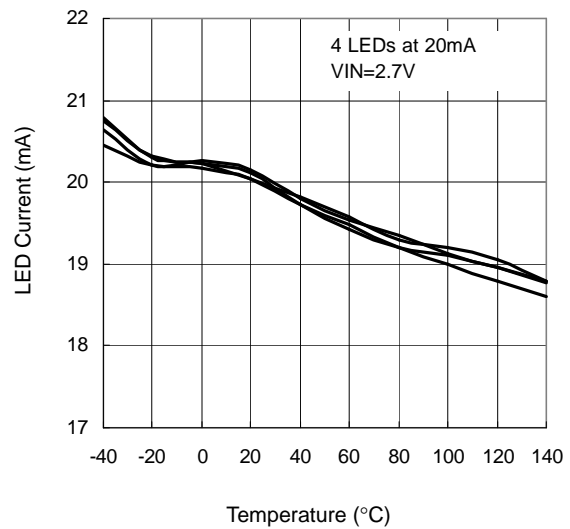

Quiescent Current vs. Temperature

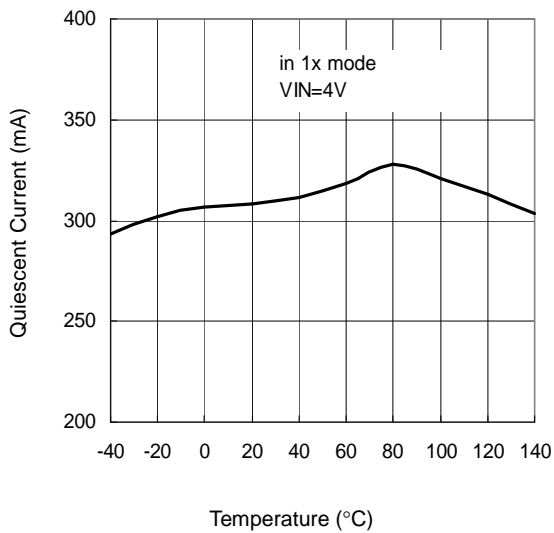

Quiescent Current vs. Input Voltage

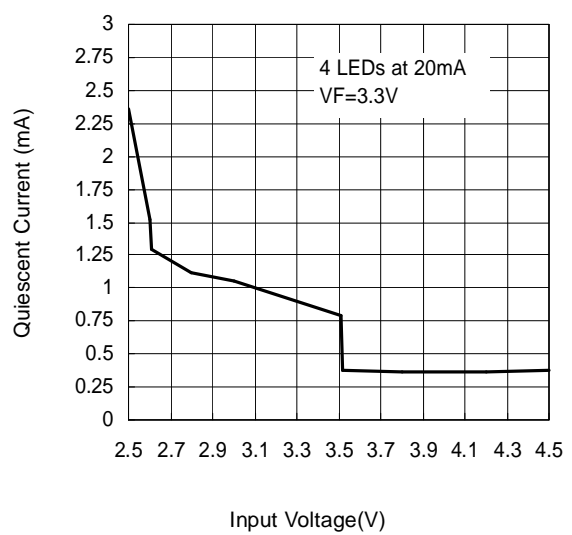

Typical Operating Characteristics (Cont.)

StartUp in 1x Mode

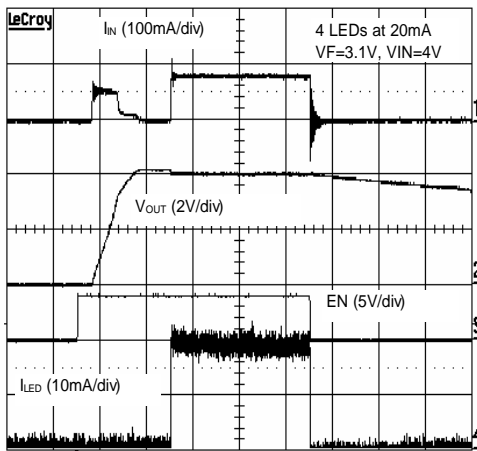

TIME (0.1ms/div)

StartUp in 1.5x Mode

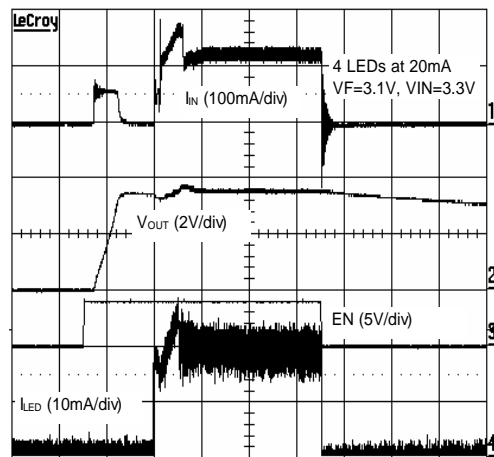

TIME (0.1ms/div)

StartUp in 2x Mode

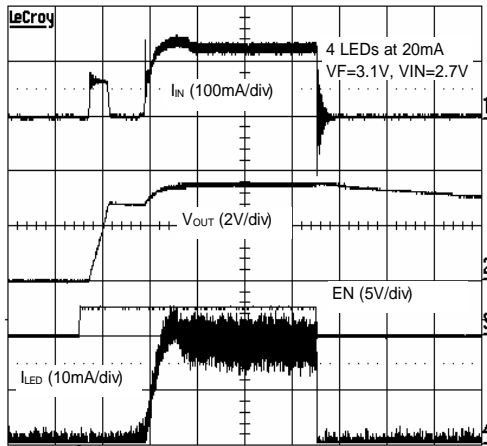

TIME (0.1ms/div)

Dimming in 1x Mode

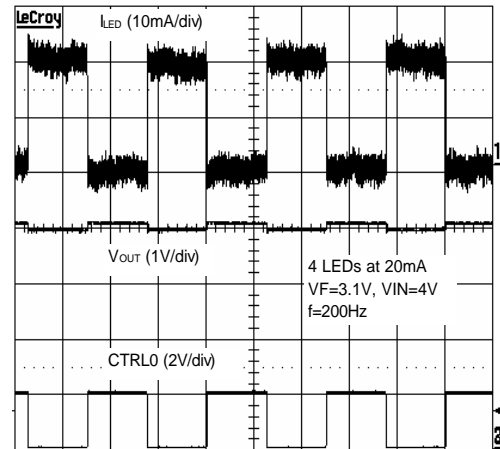

TIME (2ms/div)

Typical Operating Characteristics (Cont.)

Dimming in 1.5x Mode

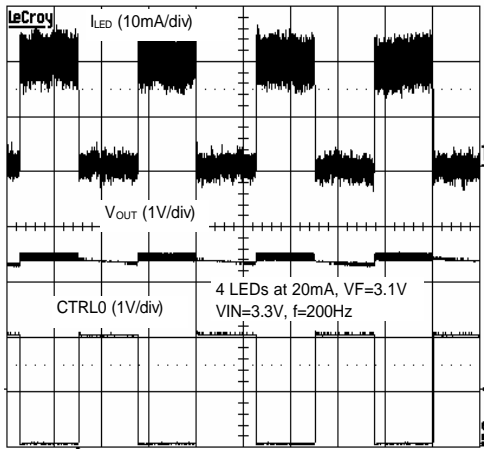

TIME (2ms/div)

Dimming in 2x Mode

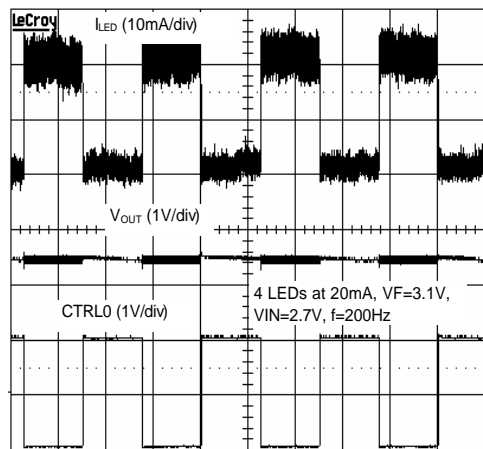

TIME (2ms/div)

OVP Even with LED Open Circuit

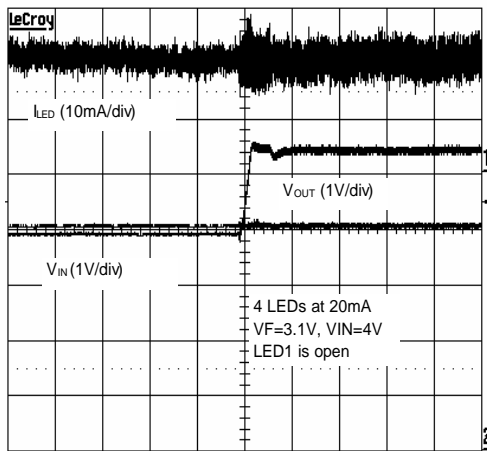

TIME (0.2ms/div)

Line Transient Response in 1x to 1.5x Mode

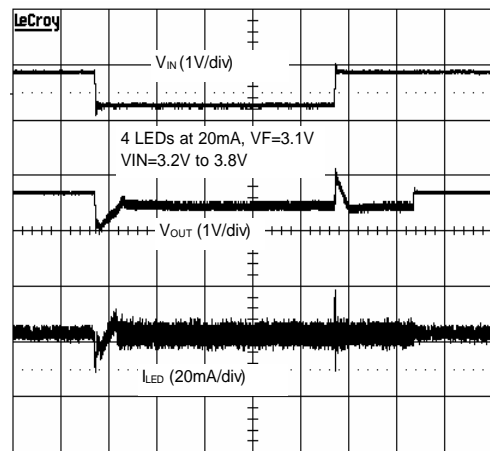

TIME (0.1ms/div)

Typical Operating Characteristics (Cont.)

Line Transient Response in 1.5x to 2x Mode

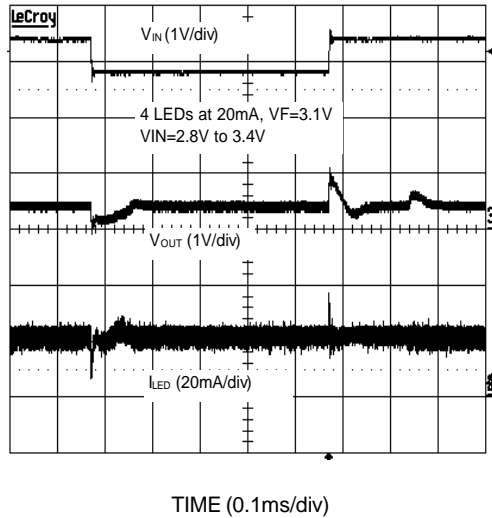

Pin Description

PIN		FUNCTION
NO.	NAME	
1	EN	Enable Input Pin. The EN pin is an active high Control. Pull EN pin above 1.3V to enable the device; pull EN pin below 0.3V to disable the device.
2	CTRL0	LED On/Off Control Pin. Allow disabling or enabling a combination of LEDs.
3	CTRL1	
4	CTRL2	
5	ISET	LED Current Set Input. Connect a resistor from ISET to GND to set the LED current. V _{ISET} is typically 1.2V.
6	VOUT	Output Voltage Pin. Connect VO _{UT} to the LED anode. Connect a 1μF capacitor from VO _{UT} to GND.
7	VIN	Supply Voltage Input Pin. Connect a 1μF capacitor from VIN to GND.
8	C2+	Bucket Capacitor1 Positive Terminal. Connect a 1μF capacitor from C2+ to C2-.
9	C2-	Bucket Capacitor1 Negative Terminal. Connect a 1μF capacitor from C2+ to C2-.
10	C1+	Bucket Capacitor1 Positive Terminal. Connect a 1μF capacitor from C1+ to C1-.
11	C1-	Bucket Capacitor1 Negative Terminal. Connect a 1μF capacitor from C1+ to C1-.
12	GND	Device Ground Pin.
13	ILED4	LEDs Cathode Connection. The LED current flows from VO _{UT} through LED into ILED_ pin. The charge pump regulates the lowest V _{ILED} to 180mV. Connect ILED_ pin to VO _{UT} if the LED is not used.
14	ILED3	
15	ILED2	
16	ILED1	

Block Diagram

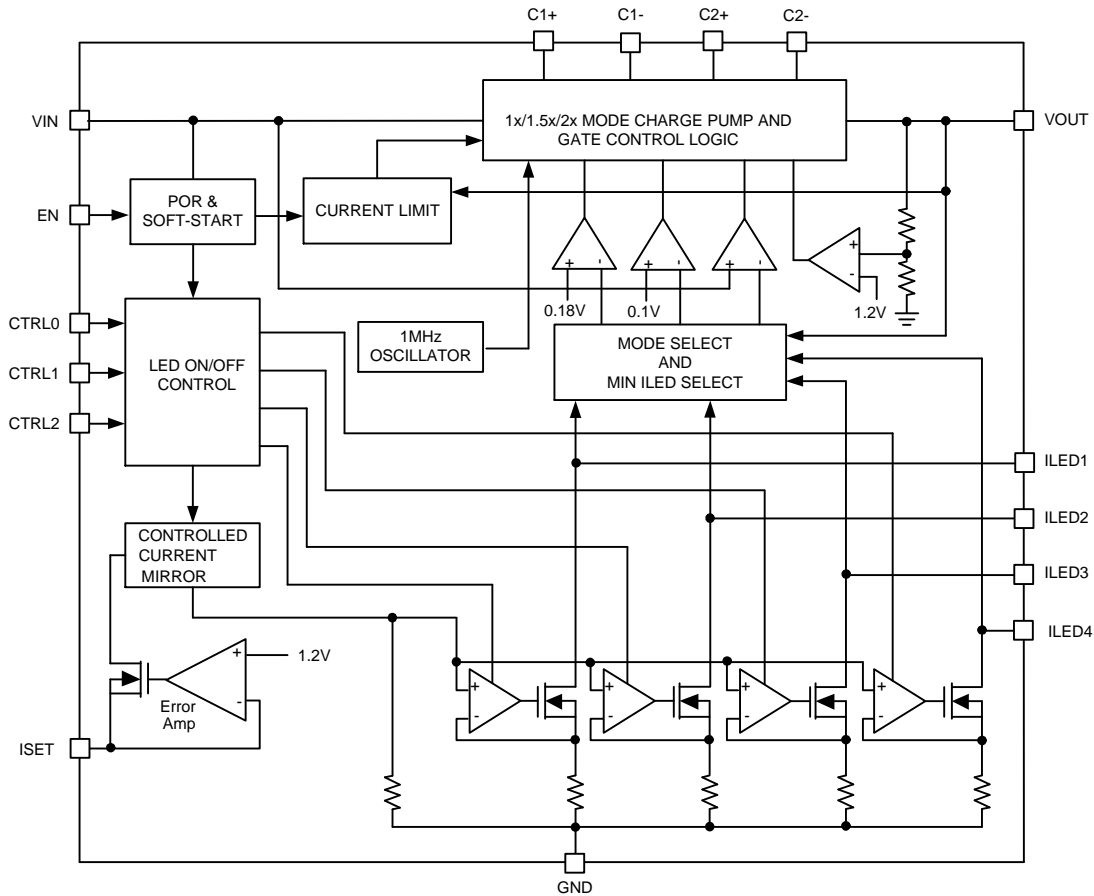

Typical Application Circuit

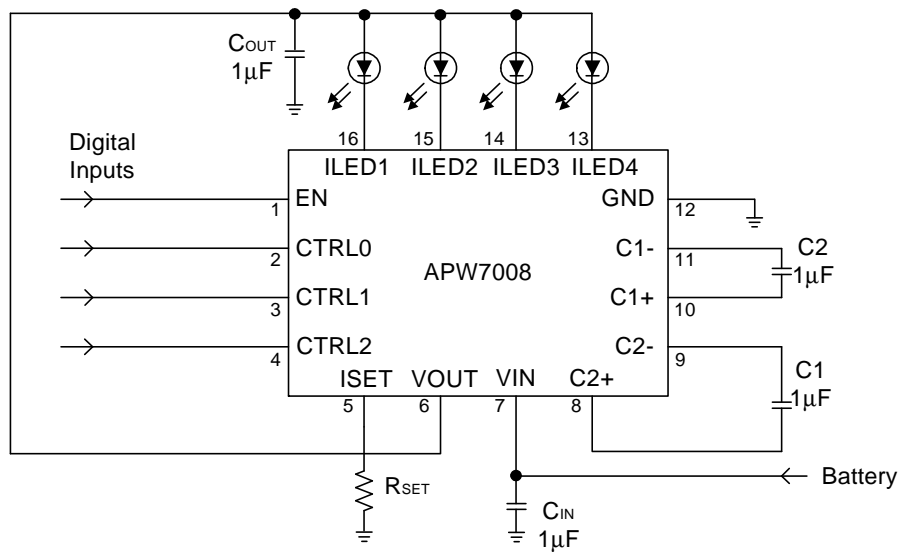

Function Description

Soft-Start

The APW7008 provides the soft-start function to limit the inrush current during start-up. When the input voltage is supplied to the device and exceeds the UVLO voltage, the output capacitor is charged directly from input with a limited current source. Approximate 100μs after the output voltage approaches the input voltage, the device starts to provide the programmed LED current and determines which of 1x and 1.5x, or 2x mode is required. When the programmed LED current can be reached with 1x mode, the soft-start is completed and the device operates in 1x mode. When the programmed LED current cannot be reached, the charge pump goes into 1.5x mode. If the 1.5x mode charge pump cannot suffice for the LED current need, the charge pump will switch to 2x mode.

Mode Transition

The APW7008 operates in 1x, 1.5x, and 2x charge pump modes and automatically switches the charge pump modes depend on the input voltage to maintain the required power for high power efficiency. If the APW7008 operates in 1x mode, the VOUT is pulled up to the VIN. When the VIN decreases, the VILED will decrease to maintain the regulated LED current. Until the VILED is below 100mV, the device will switch to 1.5x mode. In 1.5x mode, the VILED is regulated to 0.18V, and the output voltage is VF+0.18V. If the VIN continues to decrease until the VILED is below 100mV again, the device will switch to 2x mode. When the VIN rises and reaches by approximately VOUT-300mV, the APW7008 switches back to 1.5x mode. If the VIN continues to rise and reach by approximately VOUT+300mV, the APW7008 switches back to 1x mode. The 2x charge pump is enough to suffice the White LED for a Li-ion battery application. The APW7008 ensures that in the 1x mode for as long as possible to increase the efficiency and extend the operating range by using the 2x mode. The transition voltages from 1x to 1.5x and 1.5x to 2x are given by:

$$V_{TRANS1X} = VF + 0.1V + (I_{OUT} \times R_{OUT1X})$$

$$V_{TRANS1.5X} = [VF + 0.1V + (I_{OUT} \times R_{OUT1.5X})] / 1.5$$

where VF is the forward voltage of LED

I_{OUT} is the output current

R_{OUT1X} is the output impedance in 1x mode = 1.6Ω

R_{OUT1.5X} is the output impedance in 1.5x mode = 7Ω

Control Logic Pins

The APW7008 provides three logic input pins to enable or disable a combination of LEDs. Table1 shows the truth table of the logic pins. If the LED channels are not used, connecting the ILED pins to VOUT to turn off the respective LED channels.

Table 1. The Truth Table of Control Logic Pins

Control Logic Pin			LED Status			
CTRL2	CTRL1	CTRL0	LED4	LED3	LED2	LED1
0	0	0	OFF	OFF	OFF	ON
0	0	1	OFF	OFF	ON	OFF
0	1	0	OFF	ON	OFF	OFF
0	1	1	ON	OFF	OFF	OFF
1	0	0	OFF	OFF	ON	ON
1	0	1	OFF	ON	ON	ON
1	1	0	ON	ON	ON	ON
1	1	1	OFF	OFF	OFF	OFF

LED Current Setting

Connect a resistor from ISET pin to GND to set the LED current. The ISET voltage is typically 1.2V, the LED current is typically 400 times the current through the ISET resistor. The LED current is given by:

$$R_{SET} = \frac{400 \times 1.2V}{I_{LED}}$$

The APW7008 provides up 30mA of LED current per LED and the device has a max current matching of ±5% between any two LED currents and a max current accuracy of ±8%. If high accuracy is required, using a 1% precision surface mount resistor for the need.

Table 2. RSET Value Selection

I _{LED} (mA)	R _{SET} (kΩ)
5	92
10	47
15	32
20	24
30	16.5

Function Description (Cont.)

LED Current Setting (Cont.)

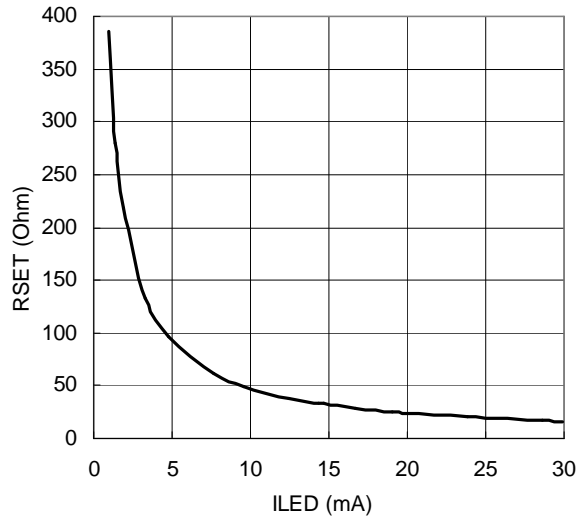

Figure 1. RSET Value vs. LED Current

Shutdown/Enable

Pull the EN above 1.3V to enable the device and pull EN pin below 0.3V to disable the device. In shutdown mode, all internal control circuits are turned off and the quiescent current is below 2 μ A. When the device exits shutdown mode, the output has soft-start function as the input voltage startup.

Over-Voltage Protection

If any of LEDs is failed or unused LED channel is not connected to VOUT, the charge pump mode will go into 2x mode and the output voltage will be pumped to 2 times the input voltage. If the output voltage is over 5.5V, the over-voltage protection circuit will limit the output voltage to approximately 5.5V.

Application Information

Capacitor Selection

For lower input and output voltage ripples, both input and output capacitors should be larger values and lower ESR capacitors. However, the larger output capacitor values will increase the soft-start time. The lower charge pump flying capacitors values and ESR improve the efficiency, but lower capacitor values may limit the LED's currents at low input voltage.

It is recommended that the low ESR and low variation over temperature, such as the ceramic capacitors with X7R or X5R and the value is 1μF for the input capacitor, output capacitor, and the charge pump flying capacitors.

Brightness Control

1. PWM dimming using CTRL0, CTRL1, CTRL2

The first method for dimming the LEDs is to apply a PWM signal into the CTRL0, CTRL1, and CTRL2 pins. Figure 2 shows the application circuit. The average LED current is proportional to the PWM signal duty cycle. Note that the frequency of PWM signal will affect the minimum dimming duty. Figure 3 shows the LED current vs. dimming frequency and dimming duty, the recommend dimming frequency is below 10kHz. The average LED current is calculated by the following equation:

$$I_{LED(avg)} = \frac{toff \times I_{LED(max)}}{ton + toff}$$

Where:

$I_{LED(max)}$ is programmed LED current by ISET pin
 toff is the off time of the PWM signal
 ton is the on time of the PWM signal

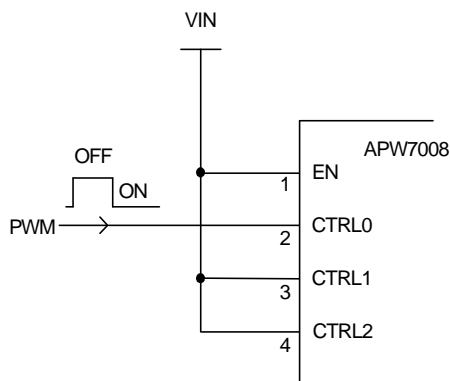

Figure 2. PWM Dimming Application Circuit

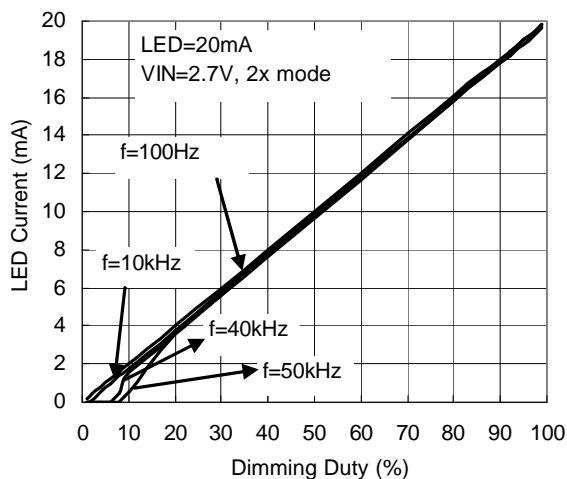

Figure 3. PWM Dimming Frequency vs. LED Current

2. Analog dimming with analog voltage

The second method for dimming the LEDs is to apply a voltage through a resistor into the ISET pin. The variation of LED current is proportional to the variation of the analog voltage. If the resistor values are chosen correctly, the analog control voltage varies the output current from 0mA to full LED current. Figure4 shows the application circuit. See the table2 and choose the required maximum LED current and the corresponsive R_{SET} value, using the below equation to calculate the values of R1 and R2, note that the V_{ADJ} will need to be greater than 1.2V.

$$\frac{V_{ADJ}}{R1} = \frac{(V_{ADJ} - V_{ISET})}{R2} + \frac{V_{ADJ}}{R_{SET}}$$

Where:

$V_{ISET} = 1.2V$

V_{ADJ} = the analog voltage for dimming the LEDs

R_{SET} = the equivalent RSET resistance (see table 2).

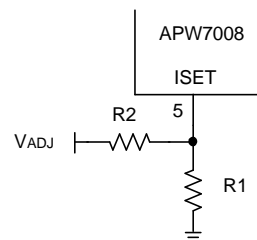

Figure 4. Analog Voltage Dimming Application Circuit

Application Information (Cont.)

Brightness Control (Cont.)

3. Digital dimming with external NMOS transistors

The third method for dimming the LEDs is to change the equivalent resistance for RSET with the external NMOS transistors. The equivalent resistance is the parallel combinations of the R1, R2, R3, and R4. R4 is always connected and selected for the minimum LED current. Figure 5 shows the application circuit.

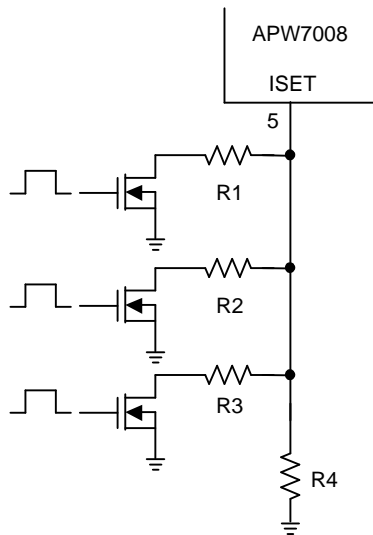

Figure 5. Digital Dimming Application Circuit

4. PWM dimming with EN pin

Another method for dimming the LEDs is to apply a PWM signal into the EN pin. The average LED current is proportional to the PWM signal duty cycle. Note that the frequency of PWM signal will affect the minimum dimming duty. The recommend dimming frequency is between 100Hz and 1kHz. The average LED current is calculated by the following equation:

$$I_{LED(avg)} = \frac{ton \times I_{LED(max)}}{ton + toff}$$

Where:

$I_{LED(max)}$ is programmed LED current by ISET pin

toff is the off time of the PWM signal

ton is the on time of the PWM signal

Layout Consideration

The APW7008 is a high frequency charge pump for white LED driver and requires some care when laying out the printed circuit board. The metal GND pad of the bottom of the package must be soldered to the PCB and connected to the GND plane on the backside through several thermal vias. Place the CIN, COUT, C1, and C2 as close to IC as possible for reducing the switching noise.

Package Information

QFN3x3-16

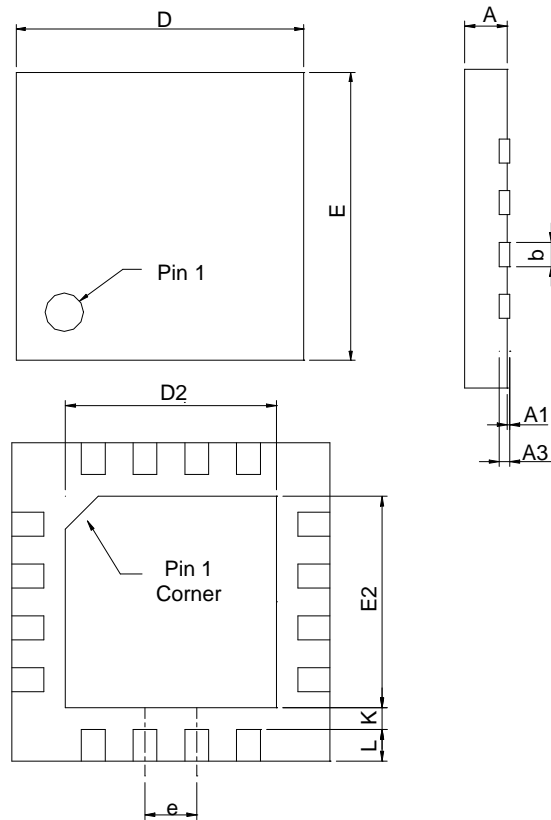

SYMBOL	QFN3x3-16			
	MILLIMETERS		INCHES	
	MIN.	MAX.	MIN.	MAX.
A	0.80	1.00	0.031	0.039
A1	0.00	0.05	0.000	0.002
A3	0.20 REF		0.008 REF	
b	0.18	0.30	0.007	0.012
D	2.90	3.10	0.114	0.122
D2	1.50	1.80	0.059	0.071
E	2.90	3.10	0.114	0.122
E2	1.50	1.80	0.059	0.071
e	0.50 BSC		0.020 BSC	
L	0.30	0.50	0.012	0.020
K	0.20		0.008	

Note : 1. Followed from JEDEC MO-220 WEED-4.

Carrier Tape & Reel Dimensions

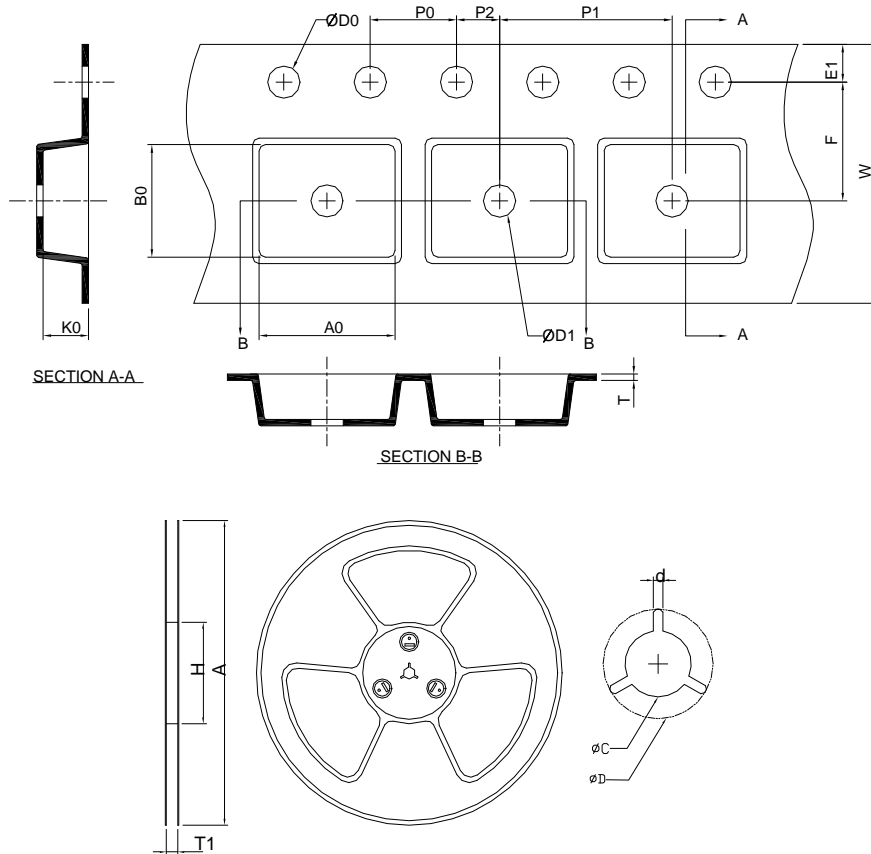

Application	A	H	T1	C	d	D	W	E1	F
QFN3x3-16	178 ±0.00	50 MIN.	12.4+2.00 -0.00	13.0+0.50 -0.20	1.5 MIN.	20.2 MIN.	12.0 ±0.30	1.75 ±0.10	5.5 ±0.05
	P0	P1	P2	D0	D1	T	A0	B0	K0
	4.0 ±0.10	4.0 ±0.10	2.0 ±0.05	1.5+0.10 -0.00	1.5 MIN.	0.6+0.00 -0.40	3.30 ±0.20	3.30 ±0.20	1.30 ±0.20

(mm)

Devices Per Unit

Package Type	Unit	Quantity
QFN3x3-16	Tape & Reel	3000

Taping Direction Information

QFN3x3-16

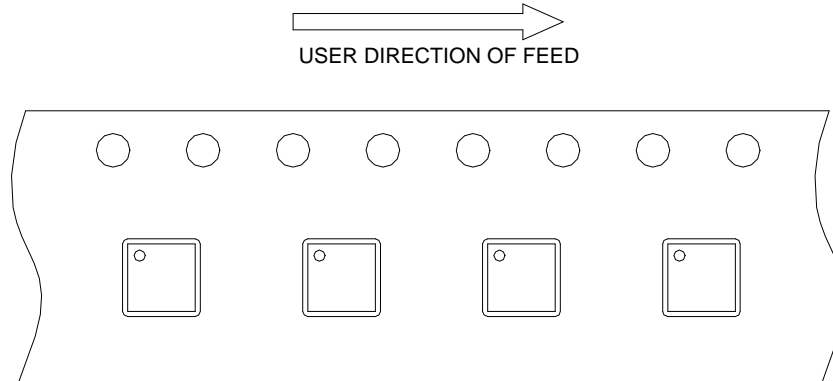

Classification Profile

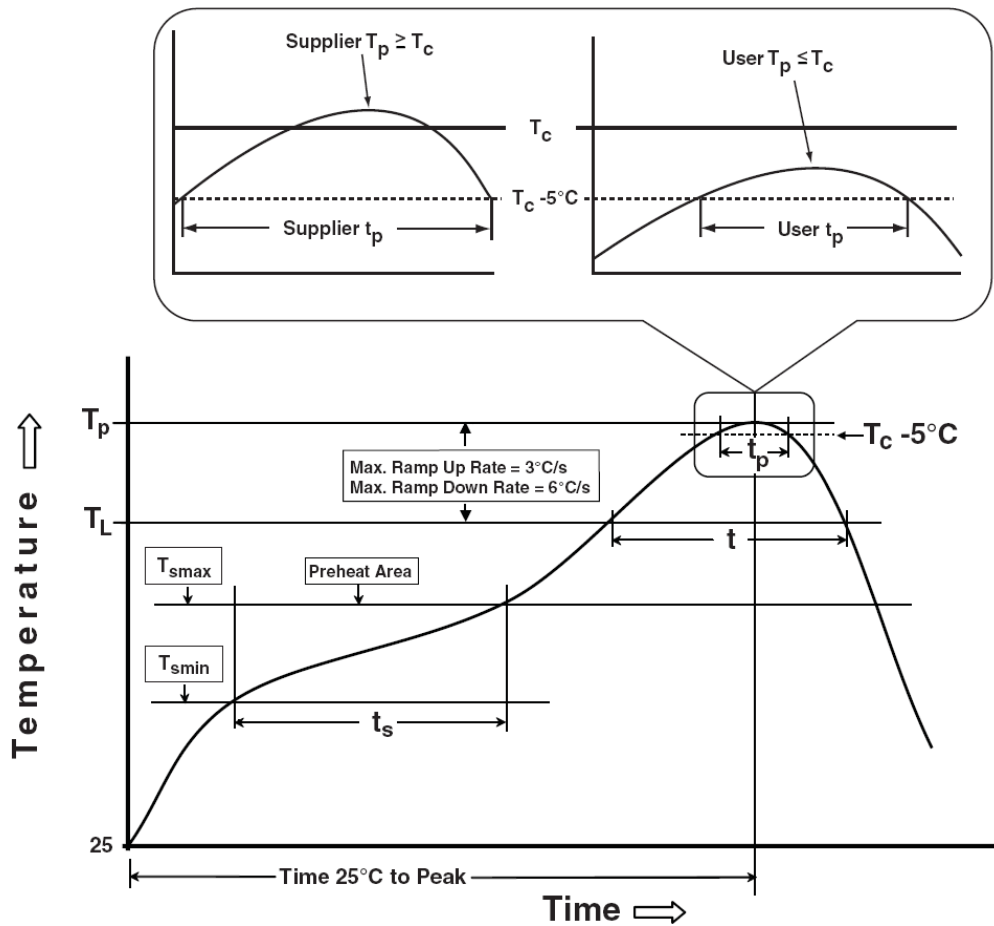

Classification Reflow Profiles

Profile Feature	Sn-Pb Eutectic Assembly	Pb-Free Assembly
Preheat & Soak Temperature min (T_{smin}) Temperature max (T_{smax}) Time (T_{smin} to T_{smax}) (t_s)	100 °C 150 °C 60-120 seconds	150 °C 200 °C 60-120 seconds
Average ramp-up rate (T_{smax} to T_p)	3 °C/second max.	3°C/second max.
Liquidous temperature (T_L) Time at liquidous (t_L)	183 °C 60-150 seconds	217 °C 60-150 seconds
Peak package body Temperature (T_p)*	See Classification Temp in table 1	See Classification Temp in table 2
Time (t_p)** within 5°C of the specified classification temperature (T_c)	20** seconds	30** seconds
Average ramp-down rate (T_p to T_{smax})	6 °C/second max.	6 °C/second max.
Time 25°C to peak temperature	6 minutes max.	8 minutes max.
* Tolerance for peak profile Temperature (T_p) is defined as a supplier minimum and a user maximum. ** Tolerance for time at peak profile temperature (t_p) is defined as a supplier minimum and a user maximum.		

Table 1. SnPb Eutectic Process – Classification Temperatures (T_c)

Package Thickness	Volume mm ³ <350	Volume mm ³ ≥350
<2.5 mm	235 °C	220 °C
≥2.5 mm	220 °C	220 °C

Table 2. Pb-free Process – Classification Temperatures (T_c)

Package Thickness	Volume mm ³ <350	Volume mm ³ 350-2000	Volume mm ³ >2000
<1.6 mm	260 °C	260 °C	260 °C
1.6 mm – 2.5 mm	260 °C	250 °C	245 °C
≥2.5 mm	250 °C	245 °C	245 °C

Reliability Test Program

Test item	Method	Description
SOLDERABILITY	JESD-22, B102	5 Sec, 245°C
HOLT	JESD-22, A108	1000 Hrs, Bias @ 125°C
PCT	JESD-22, A102	168 Hrs, 100%RH, 2atm, 121°C
TCT	JESD-22, A104	500 Cycles, -65°C~150°C
HBM	MIL-STD-883-3015.7	VHBM 2KV
MM	JESD-22, A115	VMM 200V
Latch-Up	JESD 78	10ms, 1 _{tr} 100mA

Customer Service

Anpec Electronics Corp.

Head Office :

No.6, Dusing 1st Road, SBIP,
Hsin-Chu, Taiwan, R.O.C.
Tel : 886-3-5642000
Fax : 886-3-5642050

Taipei Branch :

2F, No. 11, Lane 218, Sec 2 Jhongsing Rd.,
Sindian City, Taipei County 23146, Taiwan
Tel : 886-2-2910-3838
Fax : 886-2-2917-3838

