

Features

- Input Voltage Range is up to 7V
- Dropout Voltage 400mV at 300mA Output Current
- Guaranteed 300mA Output Current
- Internal $R_{ON} = 1.5\Omega$ PMOS Draws No Base Current
- Low Quiescent Current 50 μ A
- Output Voltage: 1.5V/1.8V/2.0V/2.5V/2.8V/3.0V/3.3V/3.5; Accuracy 2%
- Fast Transient Response
- Good Load Regulation
- Current Limit and Thermal Shutdown Protection
- Short Circuit Current Fold-Back
- Lead Free Finish/RoHS Compliant for Lead Free products (Note 1)
- Lead-Free Packages: SC59R-3L, SOT89-3L, and SOT89R-3L
- Green Package: SC59R-3L

General Description

The AP130 is a 300mA, fixed output voltage, low dropout linear regulator. The device includes pass element, error amplifier, band-gap, current-limit and thermal shutdown circuitry. The characteristics of low dropout voltage and less quiescent current make it good for some critical current application, for example, some battery powered devices. The typical quiescent current is approximately 50 μ A from zero to maximum load. Due to internal flexible design, result in extensively fixed output voltage versions and make it convenient to use for applications. Built-in current-limit and thermal-shutdown functions prevent any fault condition from IC damage.



Applications

- Battery Powered Device
- CD-ROM, DVD, and LAN Card
- Wireless Peripheral
- Wireless Communication

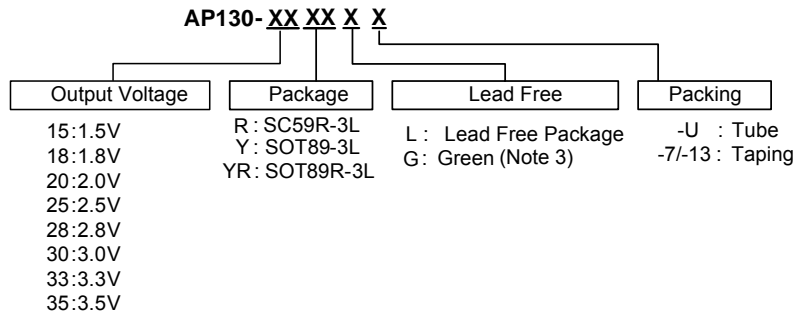
Ordering Information



Note: 1. RoHS revision 13.2.2003. Glass and High Temperature Solder Exemptions Applied, see *EU Directive Annex Notes 5 and 7*.

Device	Package Code	Packaging (Note 2)	7" Tape and Reel		13" Tape and Reel	
			Quantity	Part Number Suffix	Quantity	Quantity
 AP130-XXR	R	SC59R-3L	3000/Tape & Reel	-7	NA	NA
 AP130-XXY	Y	SOT89-3L	NA	NA	2500/Tape & Reel	-13
 AP130-XXYR	YR	SOT89R-3L	NA	NA	2500/Tape & Reel	-13

Note: 2. Pad layout as shown on Diodes Inc. suggested pad layout document AP02001, which can be found on our website at <http://www.diodes.com/datasheets/ap02001.pdf>.
 3. Green is only for SC59R-3L.

Pin Configuration

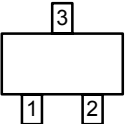
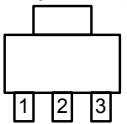
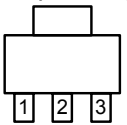
Package		No.	Name	Description
Type	Code			
(Top View)  (SC59R)	R	1	GND	IN: Power Input OUT: Output Voltage GND: Ground
		2	OUT	
		3	IN	
(Top View)  (SOT89)	Y	1	OUT	
		2	GND	
		3	IN	
(Top View)  (SOT89R)	YR	1	GND	
		2	IN	
		3	OUT	

Block Diagram

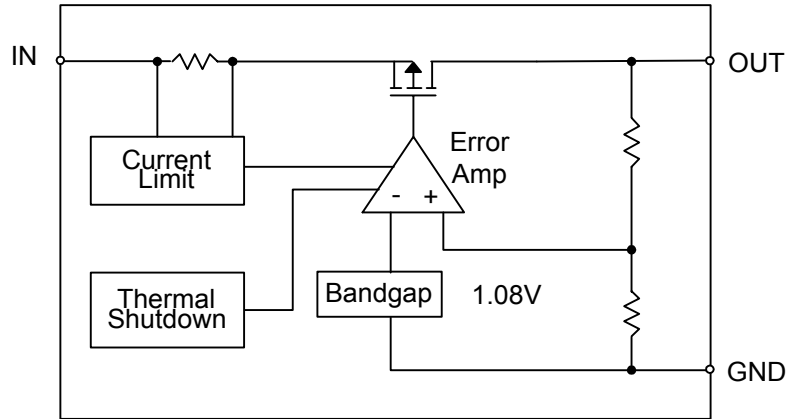

Absolute Maximum Ratings

Symbol	Parameter	Rating	Unit
V_{CC}	Input Voltage	+7	V
T_{OP}	Operating Ambient Temperature Range	-40 to +125	°C
T_{ST}	Storage Temperature Range	-65 to +150	°C
P_D	Power Dissipation, $P_D @ T_A = 25^\circ C$		
	SOT89-3L/SOT89R-3L	+0.5	W
	SC59R-3L	+0.25	W
θ_{JA}	Package Thermal Resistance		
	SOT89-3L/SOT89R-3L	+100	°C/W
	SC59R-3L	+250	°C/W

Electrical Characteristics

$T_A = 25^\circ\text{C}$, $C_{IN} = 1\mu\text{F}$, $C_{OUT} = 10\mu\text{F}$, unless otherwise specified.

Symbol	Parameter	Conditions	Min.	Typ.	Max.	Unit
V_{DROP}	Dropout Voltage (Note 4)	$I_L = 300\text{mA}$	-	400	500	mV
I_{LIMIT}	Current Limit (Note 5)	$V_{IN} = 5\text{V}$, $V_{OUT} = 0\text{V}$	350	450	-	mA
I_{short}	Short Circuit Current	$V_{OUT} < 1.05\text{V}$	-	150	300	mA
ΔV_{LINE}	Line Regulation	$I_{OUT} = 1\text{mA}$, $V_{IN} = (V_{OUT} + 1\text{V})$ to 5.5V	-	0.1	0.3	%/V
PSRR	Ripple Rejection	$F = 100\text{Hz}$, $C_{IN} = 1\mu\text{F}$, $C_O = 10\mu\text{F}$, $I_L = 100\text{mA}$	-	58	-	dB
ΔV_{LOAD}	Load Regulation (Note 6)	$I_L = 1\sim 300\text{mA}$, $V_{IN} = 5\text{V}$	-	30	40	mV
ΔV_{OUT}	Output Voltage Accuracy	$I_L = 1\text{mA}$, $V_{IN} = 5\text{V}$	-2	-	+2	%
	Output Voltage Temperature Coefficient (Note 7)		-	50	150	PPM/ $^\circ\text{C}$
I_Q	Quiescent Current	$I_L = 0\text{mA}$, $V_{IN} = 5\text{V}$	-	50	100	μA

- Note:
4. Dropout voltage is defined as the input to output differential voltage. Dropout is measured at constant junction temperature by using pulsed ON time, and the criterion is V_{OUT} inside target value $\pm 2\%$. This test is skipped at the condition of $V_{IN} < 3\text{V}$.
 5. Current limit is measured at constant junction temperature by using pulsed testing with a low ON time.
 6. Regulation is measured at constant junction temperature by using pulsed testing with a low ON time.
 7. Guaranteed by design.

Typical Characteristics

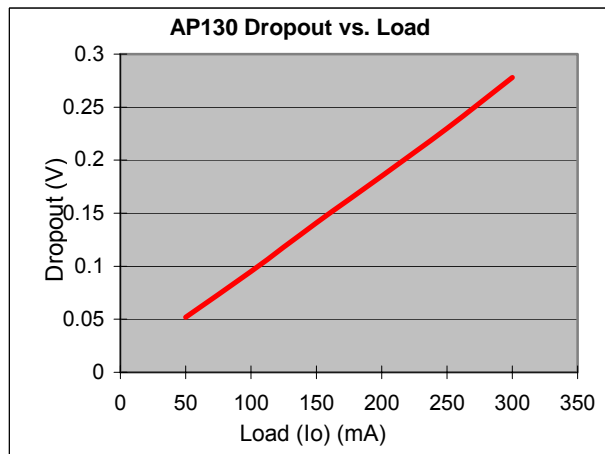
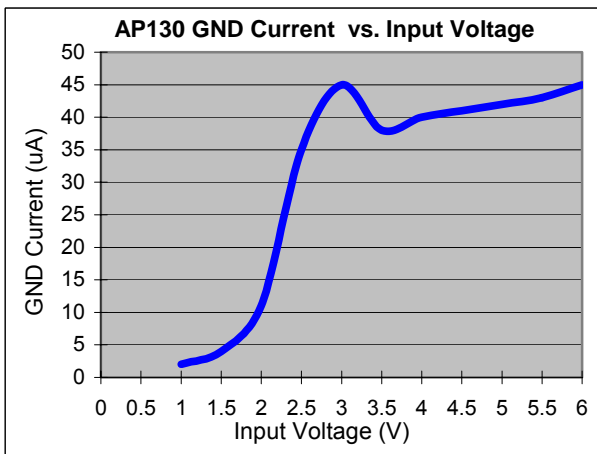
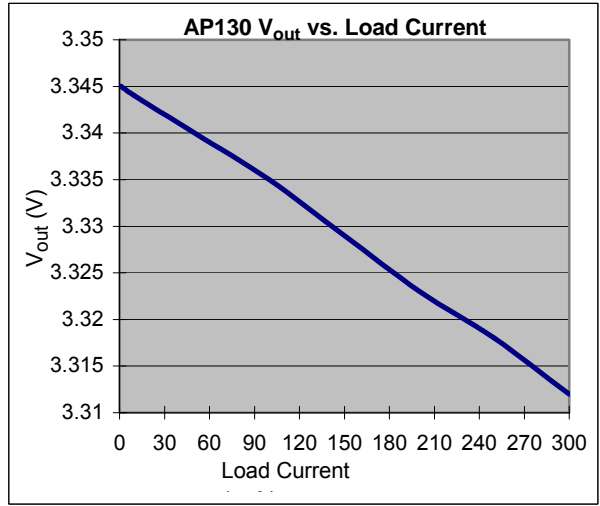
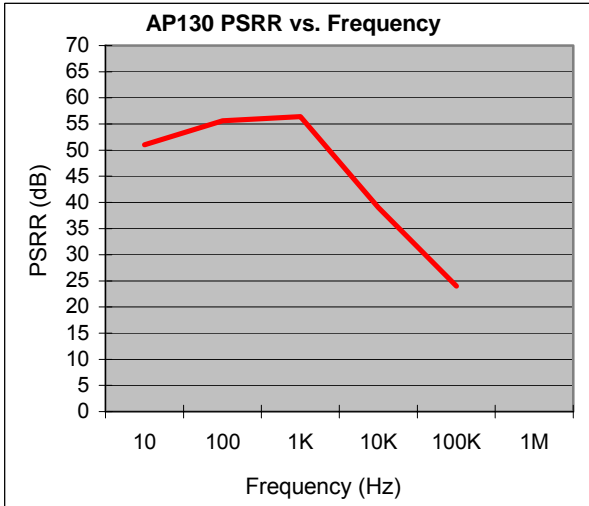

Typical Application Circuit

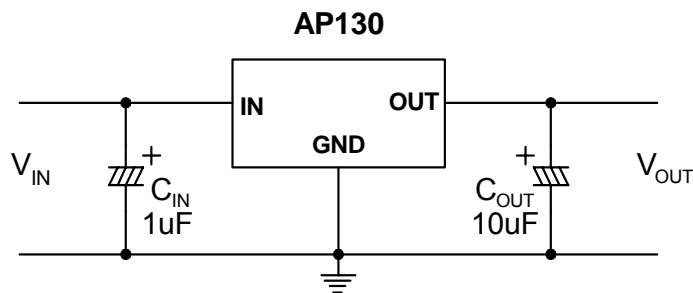

Function Description

A minimum of 10µF capacitor must be connected from OUT to ground to insure stability. Typically a large storage capacitor is connected from V_{IN} to ground to ensure that the input voltage does not sag below the minimum dropout voltage during the load transient response. This pin must always be 0.7V higher than V_{OUT} in order for the device to regulate properly.

Marking Information

(1) SC59R-3L

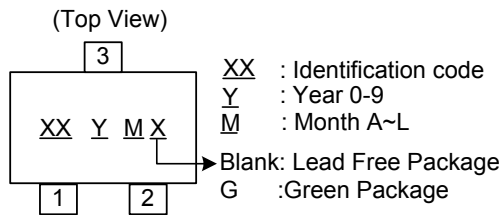

Device	Package (Note 8)	Identification Code	Date Code
AP130-15R	SC59R-3L	GO	YM
AP130-18R	SC59R-3L	GR	YM
AP130-20R	SC59R-3L	GT	YM
AP130-25R	SC59R-3L	GY	YM
AP130-28R	SC59R-3L	H1	YM
AP130-30R	SC59R-3L	H3	YM
AP130-33R	SC59R-3L	H9	YM
AP130-35R	SC59R-3L	HB	YM

(2) SOT89-3L/SOT89R-3L

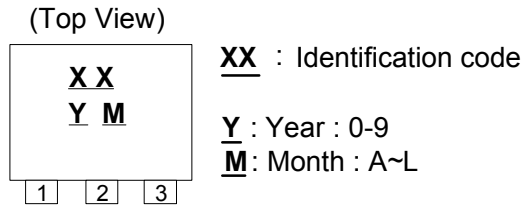

Device	Package (Note 8)	Identification Code	Date Code
AP130-15Y	SOT89-3L	CA	YM
AP130-18Y	SOT89-3L	CD	YM
AP130-20Y	SOT89-3L	CF	YM
AP130-25Y	SOT89-3L	CK	YM
AP130-28Y	SOT89-3L	CN	YM
AP130-30Y	SOT89-3L	CP	YM
AP130-33Y	SOT89-3L	CS	YM
AP130-35Y	SOT89-3L	CU	YM
AP130-15YR	SOT89R-3L	GO	YM
AP130-18YR	SOT89R-3L	GR	YM
AP130-20YR	SOT89R-3L	GT	YM
AP130-25YR	SOT89R-3L	GY	YM
AP130-28YR	SOT89R-3L	H1	YM
AP130-30YR	SOT89R-3L	H3	YM
AP130-33YR	SOT89R-3L	H9	YM
AP130-35YR	SOT89R-3L	HB	YM

Note: 8. For Packaging Details, go to our website at <http://www.diodes.com/datasheets/ap02007.pdf>.

Package Diagrams (All Dimensions in mm)

(1) Package Type: SC59R-3L

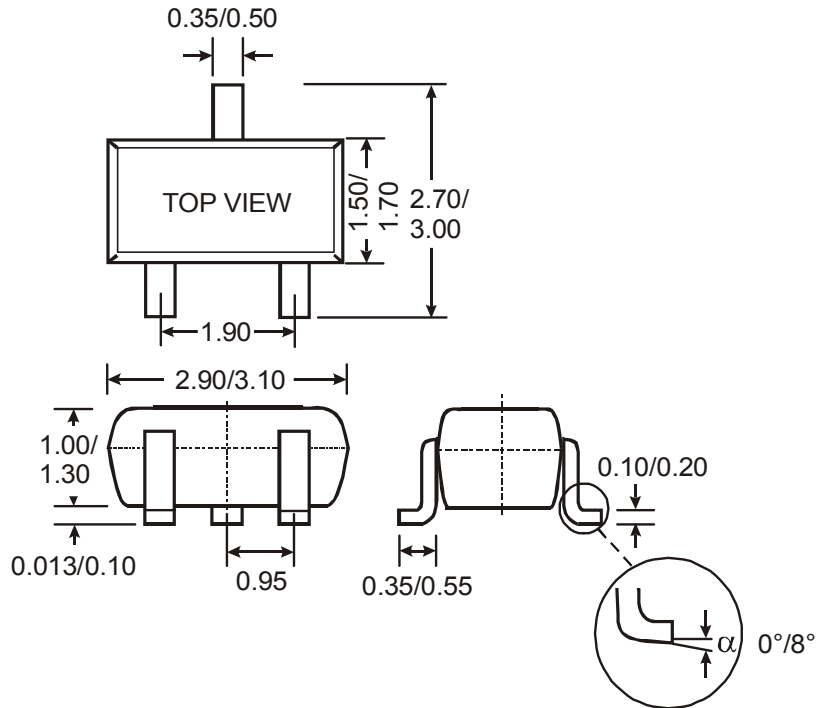

(2) Package Type: SOT89-3L/SOT89R-3L

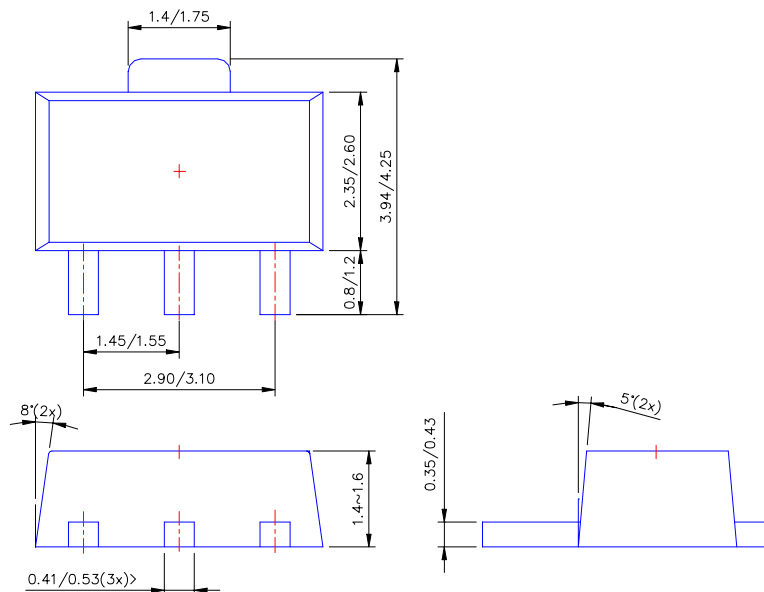

IMPORTANT NOTICE

Diodes Incorporated and its subsidiaries reserve the right to make modifications, enhancements, improvements, corrections or other changes without further notice to any product herein. Diodes Incorporated does not assume any liability arising out of the application or use of any product described herein; neither does it convey any license under its patent rights, nor the rights of others. The user of products in such applications shall assume all risks of such use and will agree to hold Diodes Incorporated and all the companies whose products are represented on our website, harmless against all damages.

LIFE SUPPORT

Diodes Incorporated products are not authorized for use as critical components in life support devices or systems without the expressed written approval of the President of Diodes Incorporated.