

Panasonic

2012

Digital Television Solution



DTV

Offering Panasonic's latest di

Our company as a semiconductor manufacturer with a wide range of industry-customers during development of television-related products.

We will continue to provide ever-higher levels of technological innovation to products and solutions with the aim of contributing to the creation of new

Contents

1 Application Block Diagram.....	2
2 Recommended Product List.....	3
3 Details of Units Comprising TV Systems.....	4
1. Digital Video Processing Units.....	4
1-1 Front-end Demodulator LSIs.....	4
1-2 Digital Back-ends.....	4
2. TV Tuner Unit: Head Amp IC.....	5
3. Audio Multiplexer Units: Audio Multiplexer/Demodulator ICs.....	5
4. Power Supply Unit.....	6
4-1 Intelligent Power Device (IPD).....	6
4-2 MOS FET for DC-DC Converters.....	6
4-3 Fast Recovery Diodes (FRD).....	7
4-4 Schottky Barrier Diodes (SBD).....	7
4-5 DC-DC Converter IC.....	8
4-6 DTV System Power Supply.....	8
5. Luminance Sensor.....	9
6. Remote Control Receptor: Photo IC.....	9
7. SD Card Interface.....	10
7-1 SD-IP.....	10
7-2 SDXC Power Supply.....	10
7-3 Switching Diodes.....	11
7-4 ESD Protective Diode.....	11
7-5 Zener Diodes.....	12
7-6 Bipolar Transistors.....	12
8. PDP Panel Control Units.....	13
8-1 IGBT.....	13
8-2 Fast Recovery Diodes (FRD).....	13
8-3 Luminance Sensor.....	14
8-4 Power Supply Unit (Intelligent Power Device (IPD)).....	14
8-4 Power Supply Unit (MOS FET).....	15
8-4 Power Supply Unit (Schottky Barrier Diodes (SBD)).....	15
9. LCD Panel Control Units.....	16
9-1 Source Driver/Gate Driver.....	16
9-2 Luminance Sensor.....	16
9-3 Power Supply Unit (MOS FET).....	17
9-3 Power Supply Unit (Schottky Barrier Diodes (SBD)).....	17
10. Backlight Units.....	18
10-1 LED driver ICs for LCD TV backlights.....	18
10-2 Inverter Units (MOS FET).....	18
10-3 Inverter Unit (SBD).....	19
10-4 LCD Panel Fluorescent Lamp Circuit Boards (MOS FET).....	19

Digital television solutions.

prominent product groups and solutions, can respond to the various needs of provide comprehensive high-performance as well as ecological semiconductor lifestyles through the products of our customers.

Application Block Diagram

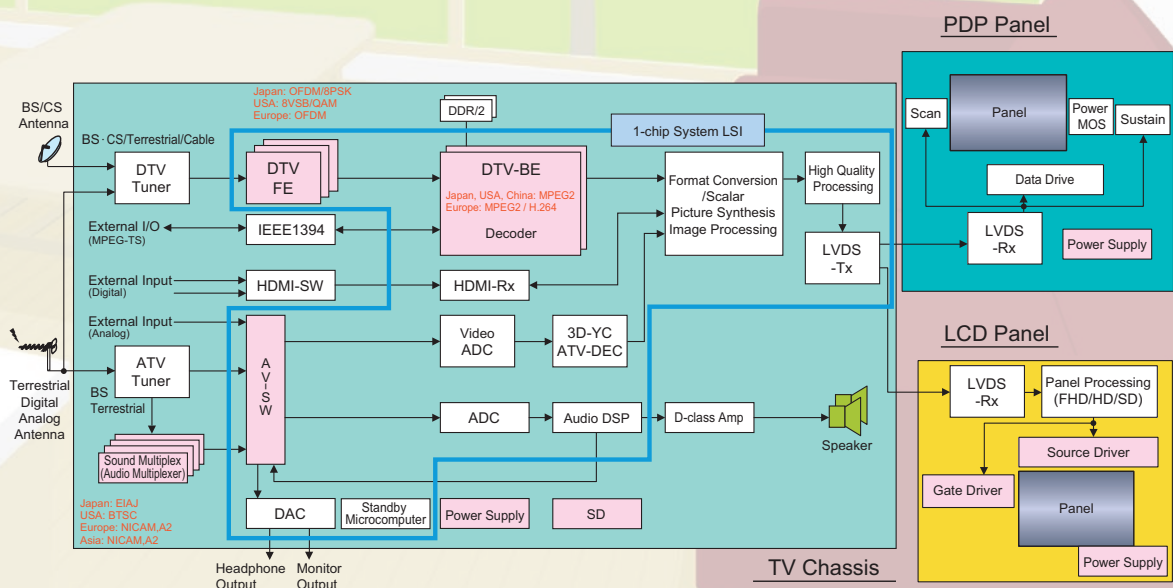

2 Recommended Product List

TV Component Units	Recommended Product	Part No.		Reference page	
Digital Video Signal Processing	Front-end Demodulator LSI	MN884433 MN88472 MN884442UB	MN884434 MN884441UB	4	
	Digital Back-end	PH1-sLD2H	PH1-Lite II s	4	
Digital TV Tuner	Head Amplifier ICs	AN26112A	AN26113A	5	
		AN26130A AN26132A	AN26131A		
Audio Multiplexer Units	Audio Multiplexer/Demodulator ICs	AN16903A	AN27013A	5	
Power Supply Unit	Intelligent Power Device (IPD) (Customer limitation)	MIP2Ex Series MIP2Fx Series MIP2Mx Series	MIP3Ex Series MIP2Kx Series MIP004xx	6	
	MOS FET for DC-DC Converters	SK860301 SK860302 SK850305 SK850306 SK840303 SK830305 SK830306	FK8V0303 FK8V0305 FC8V3303 FC8J3304 FK8V0304 FK8V0306	6	
	Fast Recovery Diodes (FRD)	DA22F21 DA24F41	▲ DA3DF30A DA2DF63	7	
	Schottky Barrier Diodes (SBD)	DB2X415 DB24404	DB24307 DB24417	7	
	DC-DC Converter IC	AN30310A others		8	
	DTV System Power Supply	AN34042A AN34044A	AN34043A	8	
	Other Units	Luminance Sensor	PNJ4K01F	PNJ4K11F	9
Remote Control Receptor (Photo IC)		PNJ4805M		9	
SD Card Interface Unit	SD-IP	MVCA1Z	MVCA2Z	10	
	SDXC Power Supply	AN34070A	AN34078A	10	
	Switching Diodes	DA2J101		11	
	ESD Protection Diode	DE2S062 DE3S062D DZ2S068C	DE2S068 DE5S062D	11	
	Zener Diodes	DZ2Jxxx Series	DZ4JxxxK Series	12	
	Bipolar Transistors	DSA5001 DRA51xxx DSC5501	DSC5001 DRC51xxx	12	
	Panel Component Units	Recommended Product	Part No.		Reference page
PDP Panel Control Unit		IGBT	▲ DG3C301	▲ DG3C302	13
	Fast Recovery Diodes (FRD)	▲ DA3DF30A	▲ DA3DF42A	13	
		▲ DA3DF51A			
	Luminance Sensor	PNJ4K01F	PNJ4K11F	14	
	Power Supply Unit (IPD) (Customer limitation)	MIP2Ex Series MIP2Mx Series	MIP3Ex Series MIP9L02MBS	14	
		(MOS FET)	FJ330301 FK3F0301 FC694301 FG694301	FK330301 FK330601 FC694601	15
	(SBD)	DB2X415 DB24404	DB24307 DB24417	15	
LCD Panel Control Units	Source Driver/Gate Driver	MN8389xx Series	MN8635xx Series	16	
	Luminance Sensor	PNJ4K01F	PNJ4K11F	16	
	Power Supply Unit (MOS FET)	FJ330301 FK330301 FK3F0301 FK330601	FC694301 FC694601 FG694301		17
		Power Supply Unit (SBD)	DB2X415 DB24404	DB24307 DB24417	17
	Backlight Units (LED drivers for backlights)	AN37010A △ AN37012A △ AN37015A	AN37011B △ AN37012B △ AN37017A		18
		(MOS FET)	FJ330301 FK330301 FK3F0301 FK330601	FC694301 FC694601 FG694301	18
	(SBD)	DB2X415 DB24404	DB24307 DB24417	19	
	LCD Panel Fluorescent Lamp Circuit Board (MOS FET)	AN37010A AN37012A AN37015A	AN37011B AN37012B AN37017A	19	

▲ : Under development

△ : Engineering samples available

3 Details of Units Comprising TV Systems

1. Digital Video Processing Units

1-1 Front-end Demodulator LSIs

■ Overview

Front-end demodulator LSIs for home-use applications in products have developed based on abundant market experience in the Japanese domestic and North American markets. Furthermore, in the Japanese domestic market, they are used for the development of products for car and portable applications.

■ Product Information

Part No.	Application	Function · Characteristics	Package
MN884433	For home-use Japanese terrestrial/satellite TV applications	<ul style="list-style-type: none"> ISDB-T OFDM demodulation ISDB-S PSK demodulation 	TQFP100-P-1212D (TQFP100 □12 mm)
MN884434	For home-use Japanese terrestrial/satellite TV applications	<ul style="list-style-type: none"> ISDB-T OFDM demodulation ×2 systems ISDB-S PSK demodulation ×2 systems 	TQFP128-P-1414C (TQFP128 □14 mm)
MN88472	For home-use European terrestrial/cable TV applications	<ul style="list-style-type: none"> DVB-T2/T OFDM demodulation DVB-C QAM demodulation 	HQFP064-P-1010B (HQFP64 □10 mm)
MN884441UB MN884442UB	For car and portable Japanese terrestrial TV applications	<ul style="list-style-type: none"> ISDB-T OFDM demodulation Quad diversity 	FBGA177-P-1313A (FBGA177 □13 mm)

■ Applications

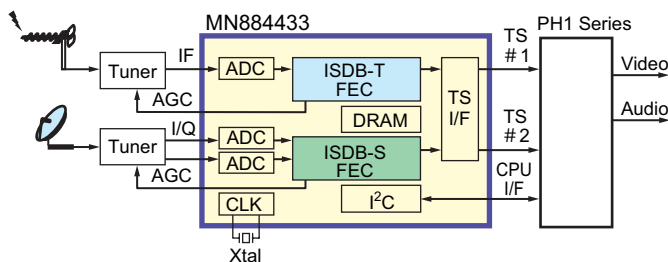

■ Image Sample

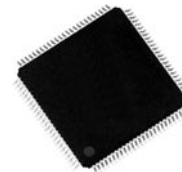

TQFP100-P-1212D

■ Points on Appeal (Features) (MN884433)

- Compatible with terrestrial digital broadcasting systems (13 seg/3 seg/1 seg).
- Compatible with satellite digital broadcasting systems (BS/CS 110°/Japanese domestic CS).
- Simultaneous or selectable reception of terrestrial and BS broadcasting.

1-2 Digital Back-ends

■ Overview

PH1 series includes flat-panel display signal processing functions and other important functions on a single chip. In addition, PH1-sLD2H has an internal multi front end (Japan/North America/Europe), making it a single-chip solution that enables digital television systems to expand globally.

■ Product Information

Part No.	Application	Function · Characteristics	Package
PH1-sLD2H	HDTV (Digital TV) Supports H.264/ MPEG2	<ul style="list-style-type: none"> Signal processing for FPDs (full HD compatibility) and current broadcasting reception on a single chip. (FE, HDMI-RX, analog AV input, peripheral functions such as TCON, etc. integrated on a single chip) Supports various media codes (VC1/JPEG, etc.) in addition to H.264/MPEG-2. Compatible with Japanese/North American/European HDTV, and current NTSC/PAL/SECAM broadcasting 	*BGA573-P-2727F1 (MN2WS0172)
PH1-Lite II s	Digital TV for car use Supports MPEG2	<ul style="list-style-type: none"> Supports TV (full-seg/one-seg) for car use. Expands home-use high-performance, high-image-quality DTV-BE to car use. 	*BGA545-P-2727A1 (MN2WS0041)

■ Applications

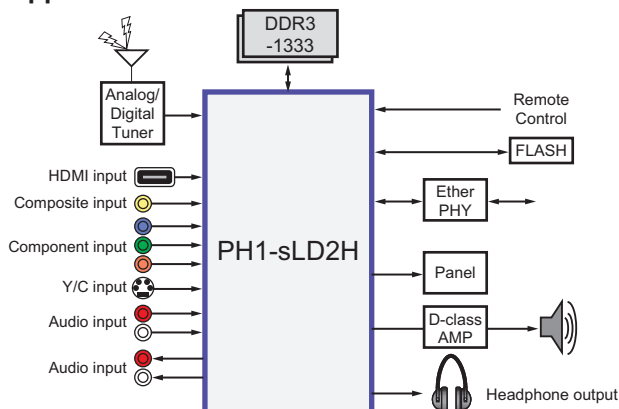

■ Image Sample



BGA545-P-2727A1

■ Points on Appeal (Features)

- Advanced one-chip DTV solution based on experience in digital TV back-end market
- Global compatibility Digital TV; Japanese/North American/European systems; Current analog NTSC/PAL/SECAM broadcasting
- Achieves high video quality HDTV in high-class to popular-class models Equipped with original high video quality circuits providing resolution covering up to full HD and a variety of customer-settable settings.

2. TV Tuner Unit: Head Amp IC

Overview

Head amp IC for TV tuners with support for VHF and UHF bands (50 MHz to 900 MHz).

Functions such as distribution, high isolation, etc. are offered to match various applications, enabling it to contribute to rationalization of TV tuner design.

Product Information

Part No.	Function	Characteristics	Package
AN26112A	Single head amp with pass-through function	DTV, STB	ULGA006-F-1517A
AN26113A	Splitter amp	DTV (TV with 2-screen support, TV with internal recorder)	ULGA006-F-1517A
AN26130A	Distribution amp with off pass-through function	STB, DVR	XLGA012-L-0303
AN26131A	Distribution amp with loop-through function	DTV, STB	XLGA012-L-0303
AN26132A	Distribution amp with loop-through function	Satellite broadcasts	XLGA012-L-0303

Applications

- High isolation

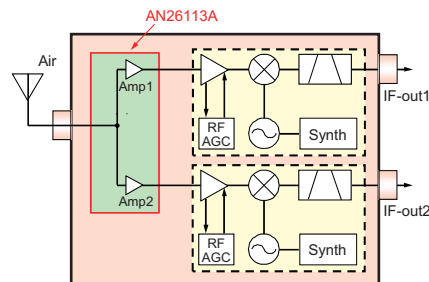

- Distribution with off pass-through function

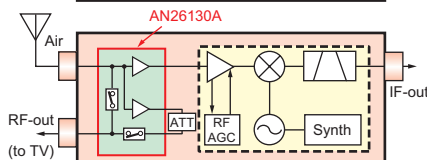
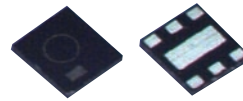
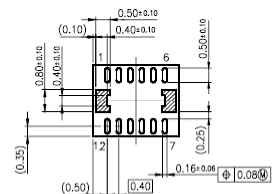

Image Sample



ULGA006-L-1517A



XLGA012-L-0303

Points on Appeal (Features)

- Low distortion (AN26113A: IIP3 + 11 dBm)
- Small package contributes to space-saving design

3. Audio Multiplexer Units: Audio Multiplexer/Demodulator ICs

Overview

TV audio multiplexer/demodulator IC. Equipped with SIF, stereo demodulation, and bilingual demodulation functions, and is compatible with both I²C control and parallel control. In addition, the AN27013A is also equipped with VIF functions. These units contribute to the rationalization of analog broadcasting equipment such as TVs, tuners, etc.

Product Information

Part No.	Function	Characteristics	Package
AN16903A	SIF / Multiplex decoder for JPN TV	MPX decode, SIF demod, AGC, dbx	SSOP024-P-0300E (SSOP24)
AN27013A	VIF / SIF / Multiplex decoder for JPN TV	VIF integrated with digital / analog AFT	LQFP048-P-0707A (QFP48)

Applications

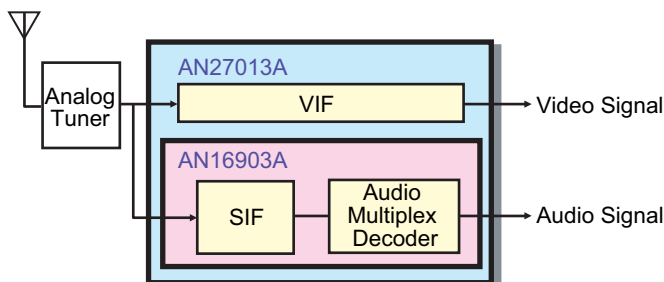

Image Sample



LQFP048-P-0707A

Points on Appeal (Features)

- Low power consumption (typ. $V_{CC} : 5\text{ V}$, $I_{tot} : 22\text{ mA}$)
- Built-in SIF demodulation circuit
- Fully adjustment-free (when using SIF input)
- Reduced external components
- Built-in VIF demodulation circuit (AN27013A)

4. Power Supply Unit

4-1 Intelligent Power Device (IPD) (Customer limitation)

Overview

The IPD employs PWM control^{*1} by the peak current control method under the rated load and intermittent oscillation control under light loads, providing high efficiency from light loads to heavy loads and contributing to low power consumption during standby. ^{*1}: MIP004xx provides peak current control type RCC control (quasi-resonance).



Product Information

⇒ For details, go to: <http://www.semicon.panasonic.co.jp/e-ipd>

Series Example	Part No.	Over-heating Protection	Overload Protection	Overvoltage Protection	Package
3 terminal saving energy at standby	MIP2Ex/3Ex series	Latch	Timer intermittence	None	TO-220-A2 DIP7-A1
For standby power supply	MIP2Mx series	Latch	Timer intermittence	Latch	DIP7-A1
For compact power supplies	MIP2Fx/2Kx series	Latch	Foldback	Latch	DIP7-A1
Control ICs	MIP004xx	Self resetting	Timer intermittence	Latch	DIP7-A1

Applications

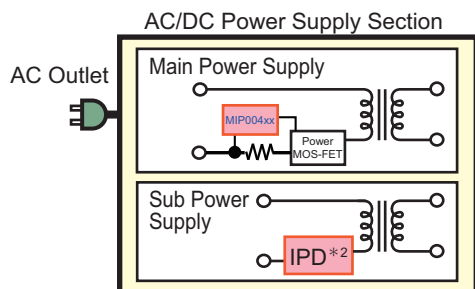

*2: Target models: MIP2Ex/3Ex, MIP2Mx, MIP2Fx/2Kx

Image Sample



Points on Appeal (Features)

- The MIP2Ex/3Ex series can be used with power sources of up to 60 W class. By limiting the number of external parts, these components allow construction of compact, simple power supplies.
- The MIP2Mx series can be used with power sources of up to 12 W class and incorporates built-in AC input detection functionality.
- The MIP2Fx/2Kx series can be used with power sources of up to 15 W class. These parts incorporate a built-in ILIMIT input compensation circuit and reduce the dependency of the maximum output voltage on the input voltage.
- In addition to dramatically simplifying noise countermeasures through a combination of quasi-resonance and jitter control, MIP004xx provides a high level of efficiency from standby through rated load operation.

Precautions

The sales and/or the export of IPD products to any customer or customers located in any country other than Japan is expressly restricted.

4-2 MOS FET for DC-DC Converters

Overview

An advanced fine process is used to achieve the industry's top class of low $R_{DS(on)}$ and low Qg values. These energy-saving devices help increase efficiency.

Product Information

Polarity	Part No.	V_{DSS} (V)	V_{GSS} (V)	I_D (A)	$R_{DS(on)}$ (m Ω) typ.		Qg (nC)	C_{iss} (pF)	Package
					$V_{GS} = 4.5$ V	$V_{GS} = 10$ V			
Nch Single	SK860301	33	± 20	44	2.5	2	22.5	3500	HSO8-F1-B
	SK860302			38	3.1	2.5	19	3000	
	SK850305			18	10	7	7	950	HSO8-F2-B
	SK850306			15	13	9	6	730	
	SK840303			22	7	5	10	1450	HSSO8-F1-B
	SK830305			16	10	7	7	950	HSSO8-F2-B
	SK830306			14	13	9	6	730	
	FK8V0303			12	8	5	10.2	1100	WMini8-F1
	FK8V0304			10	11	7	7.2	750	
	FK8V0305			8	16	11	5.1	520	
FK8V0306	6.5	22	15	3.8	360				
Nch Dual	FC8V3303	33	± 20	6.5	22	15	3.8	360	WMini8-F1
	FC8J3304			5.0	48	32	2.8	220	

Applications

- Voltage increase circuit

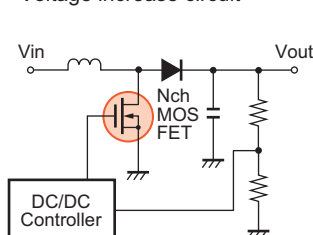

- Voltage reduction circuit/Synchronized rectifier

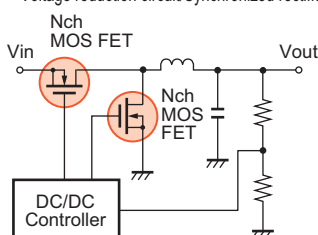

Image Sample



Points on Appeal (Features)

- Low $R_{DS(on)}$, low Qg
- Package with integrated heat sink on bottom (HSO8, HSSO8)

4-3 Fast Recovery Diodes (FRD)

Overview

Fast-recovery diodes that achieve ultra-high-speed switching characteristics and low forward voltage characteristics through the use of high-speed processes and a new structure design to greatly reduce power loss.

Product Information

Part No.	V_{RRM} (V)	I_F (A)	V_F (V)	I_{RRM} (max, μ A)	t_{rr} (max, ns)	Package
DA22F21	200	1	0.98	10	35	Mini2-F4-B
▲ DA3DF30A	350	20	1.4	10	25	TO-220D-A1
DA24F41	400	1	1.2	10	45	TMiniP2-F2-B
DA2DF63	600	10	1.7	10	40	TO-220D-B1

▲ : Under development

Applications (Switching Power Supply)

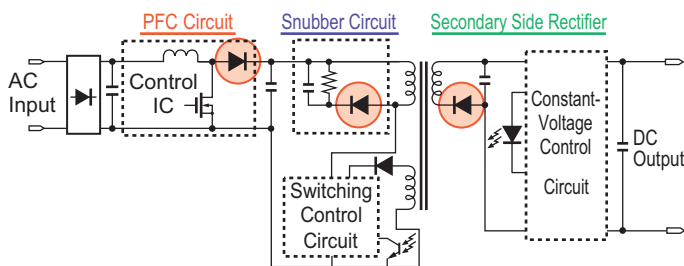

Image Sample (Units: mm)



Points on Appeal (Features)

- Ultra-high-speed switching characteristics, low I_R characteristics, low noise characteristics
- Low forward voltage characteristics

4-4 Schottky Barrier Diodes (SBD)

Overview

This series of 3 A to 5 A Schottky barrier diodes use a newly developed thin package and are ideal for on-board power supplies or secondary-side rectifiers. The TMP package uses our company's original wireless structure, providing high surge withstand levels. The lineup that we have developed, can meet a wide range of needs and includes products with low V_F , products with low I_R , and balanced type products with both low V_F and low I_R .

Product Information

Part No.	I_F	V_R	I_{FSM}^*	V_F max. (@ I_F)	I_R max. (@ V_R)	Feature	Package
	(A)	(V)	(A)	(V)	(μ A)		
DB2X415	3.0	40	15	0.55	200	Low V_F / Low I_R	Mini2-F4-B
DB24404	3.0	40	60	0.53	50	Ultra-low I_R	TMiniP2-F2-B
DB24307	3.0	30	60	0.37	2000	Ultra-low V_F	
DB24417	5.0	40	50	0.54	300	Low V_F / Low I_R	

* : Non-repetitive peak value for 1 cycle of 50 Hz sine wave

Applications

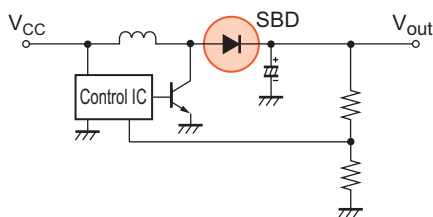
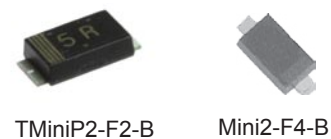

Image Sample



Points on Appeal (Features)

- Wireless structure ensures high surge withstand levels.
- Broad lineup allows selection according to the application.
- Use halogen-free resin in all part numbers

4-5 DC-DC Converter ICs

Overview

This product series can be used to boost power supply efficiency in the high-current range of up to 10 A, lowering the power consumption of host devices. It also facilitates more compact designs by implementing a high-performance power supply in a small footprint.

Product Information

	High current, medium breakdown voltage DC-DC series			High current, low breakdown voltage DC-DC series		
	NN30310A	NN30311A	NN30312A	NN30194A	NN30195A	NN30196A
Input voltage	4.5 V to 30 V			4.5 V to 5.6 V		
Absolute maximum rating	33 V			6 V		
Output voltage	0.75 V to 5.5 V			0.6 V to 3.5 V		
Output current	3 A	6 A	10 A	3 A	6 A	9 A
Step-down DC-DC	1ch			1ch		
Power transistors	2 built-in low-on-resistance trench MOS FETs					
On-resistance	High-side	25 m Ω	25 m Ω	9 m Ω	25 m Ω	25 m Ω
	Low-side	25 m Ω	9 m Ω	9 m Ω	25 m Ω	9 m Ω
Control method	Step-down hysteretic control			Step-down hysteretic control		
Oscillation frequency	0.25 M/0.75 M/1.25 MHz			0.5 M/1 M/2 MHz		
Rectification method	Synchronous rectification					
Protective functionality	Undervoltage, overheat, overvoltage, over-current, short					
Package	HQFN24-A3-0404	HQFN40-A3-0606		HQFN24-A3-0404		HQFN40-A3-0606

Applications

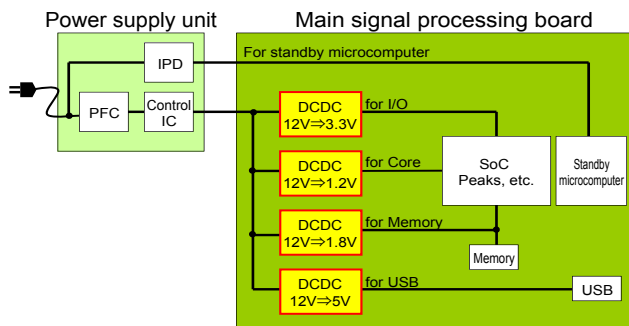

Image Sample



Points on Appeal (Features)

- Built-in low-on-resistance trench MOS FETs provide high efficiency, reducing host device power consumption and heat dissipation.
- This product series can be used to implement a high-speed-response DC-DC converter. The large safety margin provided for the operating supply voltage range contributes to the safety of the host device.
- Having fewer mounted components contributes to space-saving set designs, helping to reduce the size of host devices.

4-6 DTV System Power Supply

Overview

System power supply IC equipped with multi-channel LDO.

In addition to LDO, various other functions useful for DTV are also provided, contributing to the rationalization of DTV design.

Product Information

Part No.	LDO Output Voltage				5 V Voltage Detection	CPU Reset	Analog Mute	PWM Signal Detection	5 V → 3.3 V Level Shifter	Panel Detection	Driver Detection	Package
	9V	Built-in 3.3 V backup function	3.3 V / 1.8 V switchable	1.2 V								
AN34042A	×	○	×	○	○	○	○	○	○ (1 ch)	×	×	SSOP032-P-0300B
AN34043A	○	○	○	○					○ (2 ch)	×	×	SSOP032-P-0300B
AN34044A	○	○	○	○					○ (With 1 ch buffer)	○	○	SSOP032-P-0300B

Applications

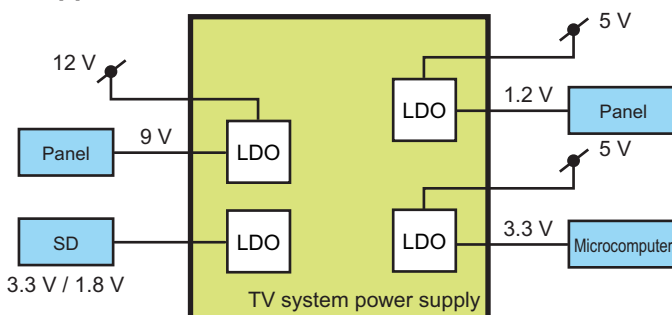

Image Sample



Points on Appeal (Features)

- Contributes to reducing space required for power supply
- Equipped with various functions for DTV
- Internal protection functions

5. Luminance Sensor

Overview

Photo IC with built-in photodiode and current amplifier circuit.
Senses ambient brightness and controls the screen brightness to maintain the screen's ease of viewing.
Has wavelength characteristics similar to the visual sensitivity of the human eye to enable control close to human senses.

Product Information

Part No.	I _{CC} typ. (μA)	I _O (V _{CC} = 3.0 V)		λ _P (nm)	Package
		L = 0 lx (μA)	L = 100 lx (μA)		
PNJ4K01F	480	4.3	43	560	KPTFTN6K0001
PNJ4K11F					KPTFTN4K0002

Applications

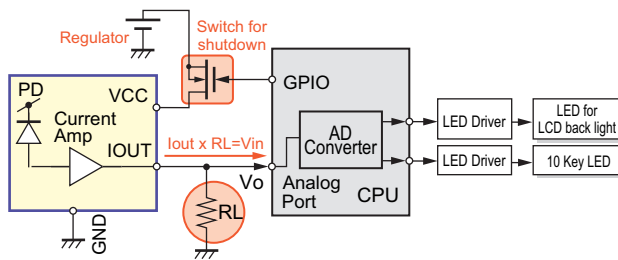
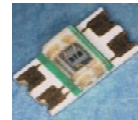

Image Sample



PNJ4K01F



PNJ4K11F

Points on Appeal (Features)

- Small package: 1.5 × 1.55 × 0.55 mm (PNJ4K01F)
- Wavelength characteristics similar to the visual sensitivity of the human eye
- Good linearity of output current in response to incident luminance
 - PNJ4K01F: Linear output
 - PNJ4K11F: Product for back-surface mounting

6. Remote Control Receptor: Photo IC

Overview

PNJ4805M is a low-current-consumption type infrared remote control receptor photo IC. Multi-voltage compatible (V_{CC} = 2.7 V to 5.5 V), so current consumption is reduced compared to previous products.
Can be used for a wide range of remote-control applications, such as digital equipment like TVs, DVD equipment, etc., home appliances such as air conditioners, etc., and game equipment or electronic toys, etc.

Product Information

(T_a = 25°C, V_{CC} = 3.3 V)

Part No.	Application	Operating Supply Voltage V _{CC} (V)			Supply Current I _{CC} (mA)			Maximum Reception Distance L (m)	Center Frequency f ₀ (kHz)	Package
		Min.	Typ.	Max.	Min.	Typ.	Max.			
PNJ4805M	For IR remote control	2.7	3.3	5.5	—	0.3	0.4	9	32.7, 36.7, 38, 40, 56.9	Miniature lead type

Applications

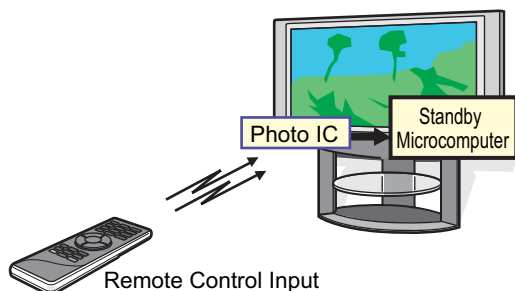

Image Sample



PNJ4805M

Points on Appeal (Features)

- Low current consumption: I_{CC} = 0.3 mA (typ.)
- Compact general-purpose package (lead type) 6.5 × 4.7 × 4.0 mm
- Abundant BPF central frequency lineup: 32.7, 36.7, 38.0, 40.0, 56.9 kHz
- Compatible with lead forming shape
- Metal holder compatible for improved EMF noise characteristics
- Pb-free (conforms to RoHS directive)

7. SD Card Interface

7-1 SD-IP

Overview

The SD Memory Card, which is being jointly developed by Panasonic Corporation, Toshiba Corporation and SanDisk Corporation, is a memory card with a copyright protection function. Matsushita was the first company to develop an SD host I/F controller embedded with an authentication and cryptographic calculation module. We ensured the quality of the controller by detailed verification with the RTL and an evaluation board. Finally, we designated the controller as IP (Intellectual Property) by means of careful documentation and have maintained the design data which is easily reusable.

Product Information

IP for SD Host

Part No.	Operating Voltage (V)	Functions	Package
MVCA1Z	—	With UHS-II-compatible CPRM, IP, SD-IO <small>Note1), Note2)</small>	—
MVCA2Z		Without UHS-II-compatible CPRM, IP, SD-IO <small>Note 1)</small>	

Note 1) For using this IP, it is necessary to enter into the SD HALA (Host/Ancillary Product License Agreement) in advance with SD-3C-LLC which is a limited liability company in Delaware in the USA, and with the SD Card Association which is a nonprofit company in California, USA. This function is not available if you have not entered into the SD HALA.

Note 2) For using the CPRM technology of this IP, it is necessary to enter into the 4C CPPM/CPRM License Agreement or CPRM For SD-binding License Agreement in advance with 4C Entity in Delaware, USA, and Founders (International Business Machines Corporation, Intel Corporation, Panasonic Corporation, and Toshiba Corporation). This function is not available if you have not entered into the 4C CPPM/CPRM License Agreement or CPRM For SD-binding License Agreement.

Note: Detailed information regarding this product will be disclosed upon conclusion of an NDA (Non-Disclosure Agreement).

Applications

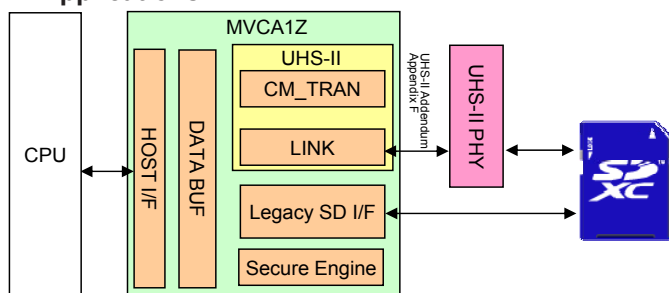

IP deliverable

- Verilog-HDL RTL source code for function simulation and synthesis
- Verilog-HDL test-bench/test-pattern source code for function simulation
- CPRM/UHS-II PHY/SD card operation encrypted model for function simulation
- Execution scripts
Simulation execution scripts, expected value comparison scripts, logic synthesis scripts, etc.
- Implementation tool for CPRM
- Sample software
Card driver, file system, authentication library
- Documentation
Register specifications, implementation manual, function specifications, how to implement CPRM, key implementation environment manual, etc.

7-2 SDXC Power Supply

Overview

AN34070A and AN34078A are high-side switching ICs for SDXC.

Provides 1.8 V / 3.3 V switching to maintain interchangeability between new and old SDXC standards.

Product Information

Part No.	Operating Voltage (V)	ON Resistance	Output Voltage (V)	Standby Current	No-load Consumption Current	Package
AN34070A	2.7 to 3.6	3 Ω	Input Voltage	Max 1 μA	Max 100 μA	SSMINI-5DC
AN34078A	2.7 to 3.6	0.45 Ω	Input Voltage / 1.8	Max 1 μA	Max 110 μA	SMINI-5DE

Applications

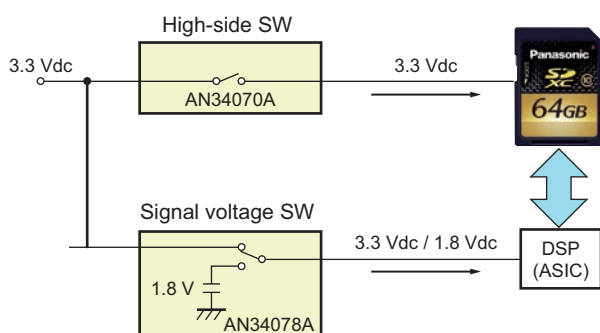
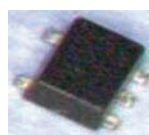
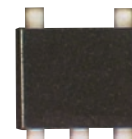

Image Sample



SSMINI-5DC



SMINI-5DE

Points on Appeal (Features)

- Compact package to contribute to space-saving design
- AN34070A is equipped with ground fault protection circuit and soft-start function.

7-3 Switching Diodes

Overview



Switching diode with high general applicability for use in a variety of applications.

Product Information

Basic Type

Part No.	V_R (V)	I_F (mA)	I_R (μ A)	V_F (V)	t_{rr} (ns)	C_t (pF)	Package
DA2J101	80	100	0.1	1.2	max. 3	typ. 1.2	SMini2-F5-B 

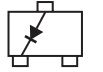
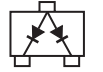
Package development (examples)

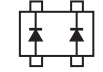
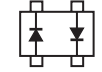
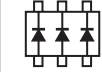
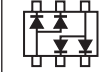
Mini3-G3-B SMini3-F2-B				Mini4-G4-B SMini4-F3-B	Mini4-G4-B	Mini6-G4-B SMini6-F3-B	Mini6-G4-B	
								

Applications

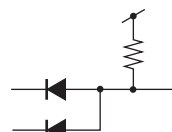

• AND Logic Circuit

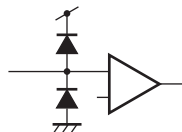

• IC Protection Circuit

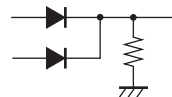

• OR Logic Circuit

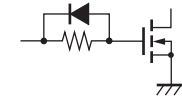

• MOS FET Gate Control

Image Sample



SMini2-F5-B

Points on Appeal (Features)

- High-density mounting can be performed.
- Short reverse recovery time t_{rr}
- Small terminal capacitance C_t
- Diverse package development to reduce number of items

7-4 ESD Protective Diode

Overview

Surge protection diodes are diodes that can handle ESD protection surges on signal lines for AV equipment, etc. and IC power lines. Full lineup of products for use in various set locations, including ESD protection type offering higher protection than previous products, low C_t type products, and bidirectional type products.

Product Information

Type	Part No.	V_{BR} (V) @1 mA	I_R (μ A)	Typ C_t (pF) @0 V / 1 MHz	ESD withstand (KV) @330 Ω / 150 pF	Number of Elements	Package
High ESD	DE2S062	5.8 to 6.6	1.0	55	± 30	1 element	SSMini2-F5-B
	DE2S068	6.4 to 7.2	500	50			
	DE3S062D	5.8 to 6.6	1.0	55	± 30	2 elements with common anode	SSMini3-F3-B
	DE5S062D	5.8 to 6.6	1.0	55	± 30	4 elements with common anode	SSMini5-F4-B
Bidirectional	DZ2S068C	6.5 to 7.5	0.05	15	± 15	1 element	SSMini2-F5-B

Applications

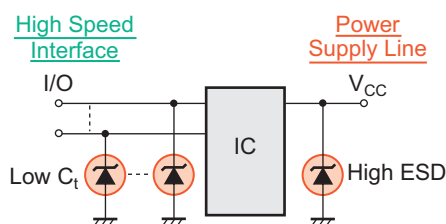

Image Sample



SSMini2-F5-B



SSMini3-F3-B

Points on Appeal (Features)

- High surge withstand of 30 kV withstand voltage guaranteed (High ESD type)
- Low C_t for high-speed I/F compatibility (Low C_t type)
- Bipolar signal line compatible for audio/video, etc. (Bidirectional type)
- Compatible with high-density mounting using SSMini package that is smaller than previous packages.

7-5 Zener Diodes

Overview

Zener diode to respond to needs for small noise voltage reduces noise voltage to 1/3 to 1/10 of that of previous products. Wide lineup with zener voltages from 2.4 V to 39 V. In the lineup is the DZ2Jxxx series with finely divided voltage rank to enable voltage selection according to the application and the DZ4JxxxK series with 2 independent elements to enable the number of mounted components to be reduced.

Product Information

Part No.	I_{FRM} (mA)	P_D (mW)	V_F (max, V)	Package
DZ2Jxxx Series	200	200	1.0	SMini2-F5-B
DZ4JxxxK Series				SMini4-F3-B

Applications

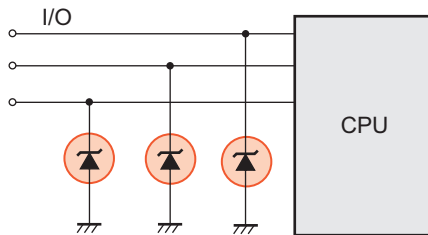

Image Sample



DZ2Jxxx
SMini2-F5-B



DZ4JxxxK
SMini4-F3-B

Points on Appeal (Features)

- Noise voltage generated from diode is extremely small.
- Good startup characteristics in low current region
- Use halogen-free resin in all part numbers

7-6 Bipolar Transistors

Overview

Our company's bipolar transistors have diverse lineups to meet various circuit needs, from general-purpose types to low noise, low $V_{CE(sat)}$ types.

Product Information

※ NV (mV)

Application	Part No.	Absolute Maximum Ratings ($T_a = 25^\circ\text{C}$)		Electrical Characteristics ($T_a = 25^\circ\text{C}$)		Package
		V_{CEO} (V)	I_C (A)	$V_{CE(sat)}$ (V)	h_{FE}	
General Purpose	DSA5001 / DSC5001	50	0.1	< 0.5 / < 0.3	210 to 460	SMini3-F2-B
General Purpose (Built-in Resistors)	DRA51xxx / DRC51xxx	-50 / 50	-0.1 / 0.1	—	—	
Low $V_{CE(sat)}$	DSC5501	20	0.5	< 0.4	200 to 800	

Applications

- General Switching Circuit
- Power Circuits
- Others

Package



SMini3-F2-B
2.0 × 2.1 × 0.9 mm
JEITA : SC-85

Points on Appeal (Features)

- Various product lineup
- Use halogen-free resin in all part numbers

8. PDP Panel Control Units

8-1 IGBT

■ Overview

IGBTs for driving PDPs that respond to the high-speed switching characteristics and low loss characteristics demands that accompany reduced power consumption and higher video quality. We have achieved the ideal IGBTs for driving PDPs by taking full advantage of the IGBT characteristic of lower power loss in the high current region compared to power MOS FETs.

■ Product Information

形名	V_{CES} (V)	I_C (A)	I_{CP} (A)	$V_{CE(sat)}$ (max, V)	t_f (typ, ns)	パッケージ
▲ DG3C301	330	40	250	1.4	115	TO-220C-G2
▲ DG3C302	330	45	250	1.3	240	TO-220C-G2

▲ : Under development

■ Applications

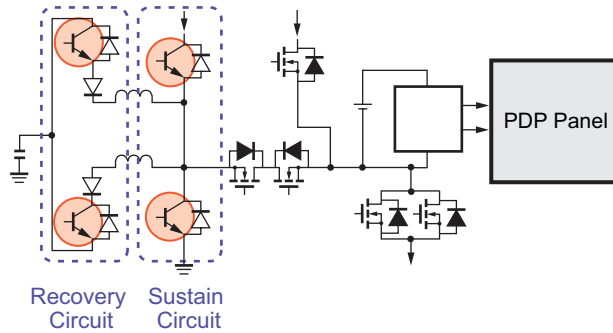

■ Image Sample



TO-220C-G2

■ Points on Appeal (Features)

- Can control high currents.
- Heat generation during circuit operation is minimized through high-speed switching and low $V_{CE(sat)}$ characteristics.

8-2 Fast Recovery Diodes (FRD)

■ Overview

Fast recovery diodes that achieve ultra-high-speed t_{rr} characteristics of 15 ns (typ.) by employing an ultra-high-speed process and a new structure design. They provide high performance for the power recovery section of PDP panel drive circuits or in applications such as high-voltage, high-frequency rectification, etc.

■ Product Information

Part No.	V_R (V)	I_F (A)	V_F (max, V)	t_{rr} (ns)	Package
▲ DA3DF30A	350	20	1.4	25	TO-220D-A1
▲ DA3DF42A	430		1.5	30	
▲ DA3DF51A	540		1.6	35	

▲ : Under development

■ Applications

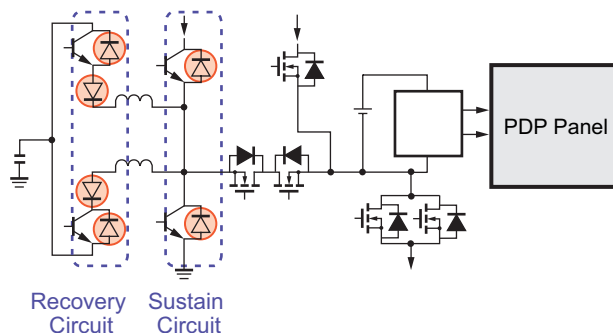

■ Image Sample



TO-220D-A1

■ Points on Appeal (Features)

- Switching loss is reduced due to high-speed t_{rr} characteristics.

8-3 Luminance Sensor

Overview

Photo IC with built-in photodiode and current amplifier circuit.
Senses ambient brightness and controls the screen brightness to maintain the screen's ease of viewing.
Has wavelength characteristics similar to the visual sensitivity of the human eye to enable control close to human senses.

Product Information

Part No.	I _{CC} typ. (μA)	I _O (V _{CC} = 3.0 V)		λ _P (nm)	Package
		L = 0 lx (μA)	L = 100 lx (μA)		
PNJ4K01F	480	4.3	43	560	KPTFTN6K0001
PNJ4K11F					KPTFTN4K0002

Applications

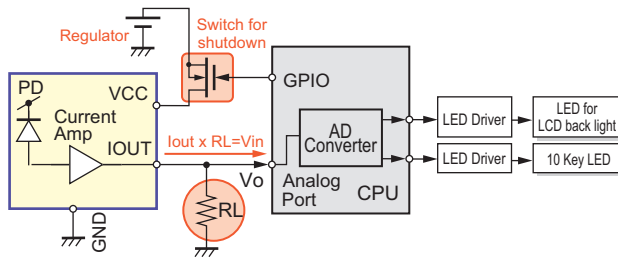

Image Sample



PNJ4K01F



PNJ4K11F

Points on Appeal (Features)

- Small package: 1.5 × 1.55 × 0.55 mm (PNJ4K01F)
 - Wavelength characteristics similar to the visual sensitivity of the human eye
 - Good linearity of output current in response to incident luminance
- PNJ4K01F: Linear output
PNJ4K11F: Product for back-surface mounting

8-4 Power Supply Unit (Intelligent Power Device (IPD)) (Customer limitation)

Overview

- MIP2Ex/3Ex/2Mx series have the 700 V breakdown voltage necessary for high voltage DC-DC converters and can be used for building compact, simple power supplies with a low number of components.
- MIP9L02MBS has a built-in output voltage detection circuit, and adjustment of output voltage is possible using an external resistor. In addition, even when the difference between input and output voltages is small, stable output can be performed.

Product Information ⇒ For details, go to: <http://www.semicon.panasonic.co.jp/e-ipd>

Part No.	Over-heating Protection	Overload Protection	Overvoltage Protection	Breakdown Voltage	fosc [kHz]	Package
MIP2Ex/3Ex Series	Latch	Timer intermittence	None	700	100	TO-220-A2 DIP7-A1
MIP2Mx Series	Latch	Timer intermittence	Latch	700	67	DIP7-A1
MIP9L02MBS	Self resetting	None	None	600	65	SDIP10-A1 (CF)

Applications

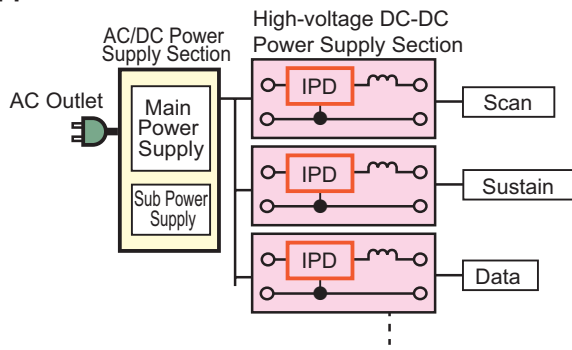
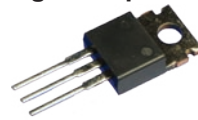
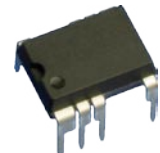

Image Sample



TO-220-A2



SDIP10-A1(CF)

Points on Appeal (Features)

- The MIP2Ex/3Ex series can be used with power sources of up to 60 W class. By limiting the number of external parts, these components allow construction of compact, simple power supplies.
- The MIP2Mx series can be used with power sources of up to 12 W class and incorporates built-in AC input detection functionality.
- MIP9L02MBS reduces the external component count and enables smaller power supplies, and can also handle power supply circuits with high output voltages and small differences between input and output voltages.

Precautions

The sales and/or the export of IPD products to any customer or customers located in any country other than Japan is expressly restricted.

8-4 Power Supply Unit (MOS FET)

Overview

Achieves the industry's top class of low $R_{DS(on)}$ through the use of cutting-edge processes. In addition, expansion into compact packages contributes to reduction of set size.

Product Information

Polarity	Function	Configuration	V_{DSS} (V)	I_D (A)	$R_{DS(on)}$ typ. (Ω)		C_{iss} (pF)	Package
					$V_{GS} = 2.5$ V	$V_{GS} = 4$ V		
Pch	FJ330301	Single	-30	-0.1	7	4	12	SSSMini3-F2-B
Nch	FK330301		30	0.1	3	2		SSSMini3-F2-B
	FK3F0301		60	0.1	8	6		ML3-N4-B
	FK330601		30	0.1	3	2		SSSMini3-F2-B
Nch × 2	FC694301	Dual	30	0.1	3	2	SSMini6-F3-B	
	FC694601		60	0.1	8	6		
Pch + Nch	FG694301		-30	-0.1	7	4		
			30	0.1	3	2		

Applications

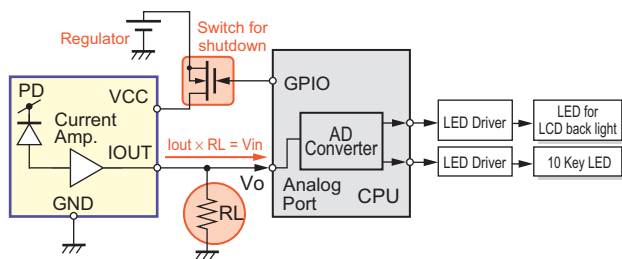

Image Sample

SSSMini3-F2-B

SSMini6-F3-B



0.8 × 1.2 × 0.51

1.2 × 1.6 × 0.55

Points on Appeal (Features)

- Low $R_{DS(on)}$
- Compact package
- Use halogen-free resin in all products

8-4 Power Supply Unit (Schottky Barrier Diodes (SBD))

Overview

This series of 3 A to 5 A Schottky barrier diodes use a newly developed thin package and are ideal for on-board power supplies or secondary-side rectifiers. The TMP package uses our company's original wireless structure, providing high surge withstand levels. The lineup that we have developed, can meet a wide range of needs and includes products with low V_F , products with low I_R , and balanced type products with both low V_F and low I_R .

Product Information

Part No.	I_F	V_R	I_{FSM}^*	V_F max. (@ I_F)	I_R max. (@ V_R)	Feature	Package
	(A)	(V)	(A)	(V)	(μ A)		
DB2X415	3.0	40	15	0.55	200	Low V_F / Low I_R	Mini2-F4-B
DB24404	3.0	40	60	0.53	50	Ultra-low I_R	TMiniP2-F2-B
DB24307	3.0	30	60	0.37	2000	Ultra-low V_F	
DB24417	5.0	40	50	0.54	300	Low V_F / Low I_R	

* : Non-repetitive peak value for 1 cycle of 50 Hz sine wave

Applications

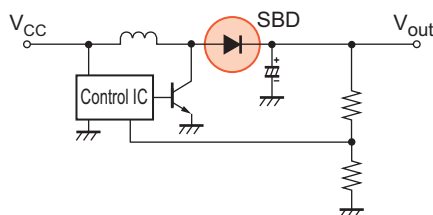

Image Sample



TMiniP2-F2-B

Mini2-F4-B

Points on Appeal (Features)

- Wireless structure ensures high surge withstand levels.
- Broad lineup allows selection according to the application.
- Use halogen-free resin in all part numbers

9. LCD Panel Control Units

9-1 Source Driver/Gate Driver

■ Overview

Driver LSIs for driving LCD panels.

Provides increased image quality on LCDs in the market and double-speed frame rates for full HD display and vivid moving images on the screen. The source driver enables multiple outputs using a newly developed low heat generation function, reducing the number of components and not only contributing to reducing the cost of LCD panel modules but also reducing the assembly labor involved, resulting in improved quality of LCD panel modules.

■ Product Information

Part No.	Application	Feature	Package
MN8389xx Series	Source driver for LCD TVs	16.5 V/720 output/250 MHz min-LVDS™	COF / BOF
MN8635xx Series	Gate driver for LCD TVs	42 V/384 output 53 V/384 output	

■ Applications

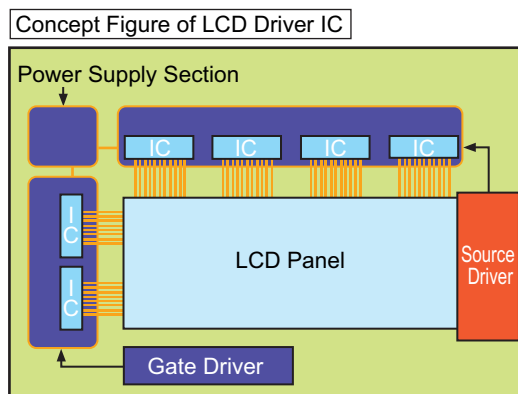

■ Image Sample



Source Driver

■ Points on Appeal (Features)

- Original low power consumption circuits reduce heat generation by half, enabling multiple outputs and contributing to reduced system cost.
- Industry's highest speed data transfer I/F is ideal for full HD double-speed drive.

9-2 Luminance Sensor

■ Overview

Photo IC with built-in photodiode and current amplifier circuit.

Senses ambient brightness and controls the screen brightness to maintain the screen's ease of viewing.

Has wavelength characteristics similar to the visual sensitivity of the human eye to enable control close to human senses.

■ Product Information

Part No.	I _{CC} typ. (μA)	I _O (V _{CC} = 3.0 V)		λ _P (nm)	Package
		L = 0 lx (μA)	L = 100 lx (μA)		
PNJ4K01F	480	4.3	43	560	KPTFTN6K0001
PNJ4K11F					KPTFTN4K0002

■ Applications

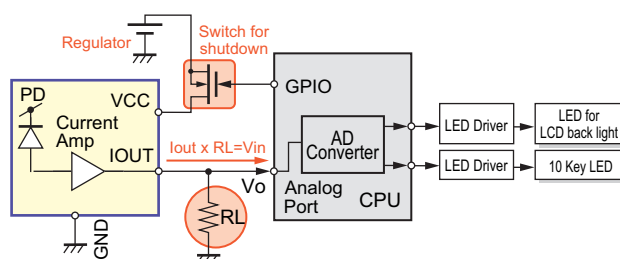

■ Image Sample



PNJ4K01F



PNJ4K11F

■ Points on Appeal (Features)

- Small package: 1.5 × 1.55 × 0.55 mm (PNJ4K01F)
- Wavelength characteristics similar to the visual sensitivity of the human eye
- Good linearity of output current in response to incident luminance
 - PNJ4K01F: Linear output
 - PNJ4K11F: Product for back-surface mounting

9-3 Power Supply Unit (MOS FET)

Overview

Achieves the industry's top class of low $R_{DS(on)}$ through the use of cutting-edge processes. In addition, expansion into compact packages contributes to reduction of set size.

Product Information

Polarity	Function	Configuration	V_{DSS} (V)	I_D (A)	$R_{DS(on)}$ typ. (Ω)		C_{iss} (pF)	Package
					$V_{GS} = 2.5$ V	$V_{GS} = 4$ V		
Pch	FJ330301	Single	-30	-0.1	7	4	12	SSSMini3-F2-B
Nch	FK330301		30	0.1	3	2		SSSMini3-F2-B
	FK3F0301		60	0.1	8	6		ML3-N4-B
Nch × 2	FC694301	Dual	30	0.1	3	2		SSMini6-F3-B
	FC694601		60	0.1	8	6		
Pch + Nch	FG694301		-30	-0.1	7	4		
			30	0.1	3	2		

Applications

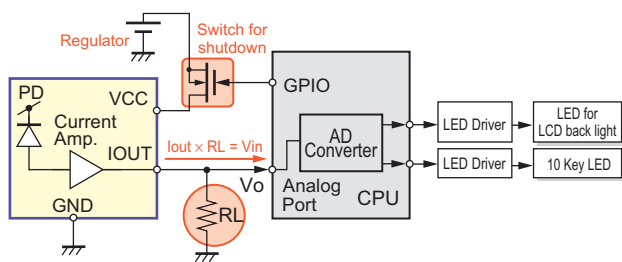

Image Sample

SSSMini3-F2-B

SSMini6-F3-B



0.8 × 1.2 × 0.51

1.2 × 1.6 × 0.55

Points on Appeal (Features)

- Low $R_{DS(on)}$
- Compact package
- Use halogen-free resin in all products

9-3 Power Supply Unit (Schottky Barrier Diodes (SBD))

Overview

This series of 3 A to 5 A Schottky barrier diodes use a newly developed thin package and are ideal for on-board power supplies or secondary-side rectifiers. The TMP package uses our company's original wireless structure, providing high surge withstand levels. The lineup that we have developed, can meet a wide range of needs and includes products with low V_F , products with low I_R , and balanced type products with both low V_F and low I_R .

Product Information

Part No.	I_F	V_R	I_{FSM}^*	V_F max. (@ I_F)	I_R max. (@ V_R)	Feature	Package
	(A)	(V)	(A)	(V)	(μ A)		
DB2X415	3.0	40	15	0.55	200	Low V_F / Low I_R	Mini2-F4-B
DB24404	3.0	40	60	0.53	50	Ultra-low I_R	TMiniP2-F2-B
DB24307	3.0	30	60	0.37	2000	Ultra-low V_F	
DB24417	5.0	40	50	0.54	300	Low V_F / Low I_R	

* : Non-repetitive peak value for 1 cycle of 50 Hz sine wave

Applications

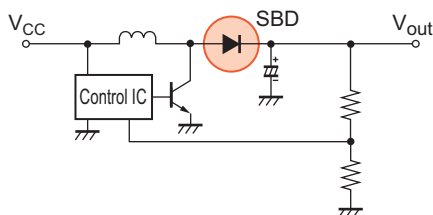

Image Sample



TMiniP2-F2-B

Mini2-F4-B

Points on Appeal (Features)

- Wireless structure ensures high surge withstand levels.
- Broad lineup allows selection according to the application.
- Use halogen-free resin in all part numbers

10. Backlight Units

10-1 LED driver ICs for LCD TV backlights

Overview

These parts are LED driver ICs for LCD TV backlights.

AN37010A: Uses a high-breakdown-voltage process and incorporates 185 V-rated output transistors to enable serial drive of multiple LEDs.

AN37012A: Incorporates a built-in heat generation countermeasures circuit to reduce the amount of heat generated by the IC.

Product Information

Part No.	Input Voltage (V)	Output Voltage (V)	Function	Package
AN37010A	10.5 to 55	max185V	4ch internal support (200 mA DC max. per channel); Boost DC-DC (external power MOS transistor); PWM intensity adjustment; Linear intensity adjustment support; Built-in protection functions	HSOP042-P-0400H
AN37011B	10.5 to 55	max185V	4ch internal support (185 V/200 mA DC max. per channel); PWM intensity adjustment; Linear intensity adjustment support; Built-in protection functions	HSOP056-P-0300F
△ AN37012A	10.5 to 40	max58V	6ch internal support (58 V/200 mA DC max. per channel); Heat generation countermeasures circuit; Boost DC-DC (external power MOS transistor); PWM intensity adjustment; Linear intensity adjustment support; Built-in protection functions	LQFP064-P-1414
△ AN37012B	10.5 to 40	max58V	6ch internal support (58 V/200 mA DC max. per channel); Heat generation countermeasures circuit; Boost DC-DC (external power MOS transistor); PWM intensity adjustment; Linear intensity adjustment support; Built-in protection functions	HSOP056-P-0300F
△ AN37015A	10.5 to 40	max58V	4ch internal support (58 V/300 mA DC max. per channel); Heat generation countermeasures circuit; Boost DC-DC (external power MOS transistor); PWM intensity adjustment; Linear intensity adjustment support; Built-in protection functions	HSOP042-P-0400H
△ AN37017A	10.5 to 55	max185V	2ch internal support (185 V/300 mA DC max. per channel); Heat generation countermeasures circuit; Boost DC-DC (external power MOS transistor); PWM intensity adjustment; Linear intensity adjustment support; Built-in protection functions	HSOP042-P-0400H

△ : Engineering samples available

Applications

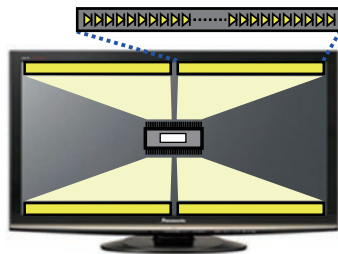

Example of 4ch architecture

Image Sample



HSOP056-P-0300F HSOP042-P-0400H LQFP064-P-1414

Points on Appeal (Features)

- Internal high-efficiency DC-DC converter (except AN37011B)
- High-breakdown-voltage process (with an IC rating of 185 V) is used to enable serial drive of multistage LEDs (AN37010A/AN37011B/AN37017A).
- Internal protection functions (over-voltage, over-current, temperature, LED open-circuit/short-circuit detection)
- Internal heat generation countermeasures circuit (AN37012A/37012B/AN37015A/AN37017A)

10-2 Inverter Units (MOS FET)

Overview

Achieves the industry's top class of low $R_{DS(on)}$ through the use of cutting-edge processes. In addition, expansion into compact packages contributes to reduction of set size.

Product Information

Polarity	Function	Configuration	V_{DSS} (V)	I_D (A)	$R_{DS(on)}$ typ. (Ω)		C_{iss} (pF)	Package
					$V_{GS} = 2.5$ V	$V_{GS} = 4$ V		
Pch	FJ330301	Single	-30	-0.1	7	4	12	SSSMini3-F2-B
Nch	FK330301		30	0.1	3	2		SSSMini3-F2-B
	FK3F0301		60	0.1	8	6		ML3-N4-B
Nch × 2	FC694301	Dual	30	0.1	3	2		SSSMini3-F2-B
	FC694601		60	0.1	8	6		
Pch + Nch	FG694301		-30	-0.1	7	4		
			30	0.1	3	2		

Applications

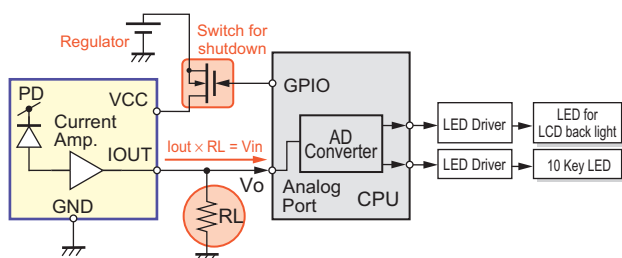

Image Sample

SSSMini3-F2-B

SSMini6-F3-B



0.8 × 1.2 × 0.51

1.2 × 1.6 × 0.55

Points on Appeal (Features)

- Low $R_{DS(on)}$
- Compact package
- Use halogen-free resin in all products

10-3 Inverter Unit (SBD)

Overview

This series of 3 A to 5 A Schottky barrier diodes use a newly developed thin package and are ideal for on-board power supplies or secondary-side rectifiers. The TMP package uses our company's original wireless structure, providing high surge withstand levels. The lineup that we have developed, can meet a wide range of needs and includes products with low V_F , products with low I_R , and balanced type products with both low V_F and low I_R .

Product Information

Part No.	I_F	V_R	I_{FSM}^*	V_F max. (@ I_F)	I_R max. (@ V_R)	Feature	Package
	(A)	(V)	(A)	(V)	(μ A)		
DB2X415	3.0	40	15	0.55	200	Low V_F / Low I_R	Mini2-F4-B
DB24404	3.0	40	60	0.53	50	Ultra-low I_R	TMiniP2-F2-B
DB24307	3.0	30	60	0.37	2000	Ultra-low V_F	
DB24417	5.0	40	50	0.54	300	Low V_F / Low I_R	

* : Non-repetitive peak value for 1 cycle of 50 Hz sine wave

Applications

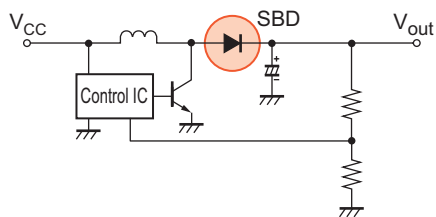

Image Sample



TMiniP2-F2-B



Mini2-F4-B

Points on Appeal (Features)

- Wireless structure ensures high surge withstand levels.
- Broad lineup allows selection according to the application.

10-4 LCD Panel Fluorescent Lamp Circuit Boards (MOS FET)

Overview

Achieves the industry's top class of low $R_{DS(on)}$ through the use of cutting-edge processes. In addition, expansion into compact packages contributes to reduction of set size.

Product Information

Polarity	Function	Configuration	V_{DSS} (V)	I_D (A)	$R_{DS(on)}$ typ. (Ω)		C_{iss} (pF)	Package
					$V_{GS} = 2.5$ V	$V_{GS} = 4$ V		
Pch	FJ330301	Single	-30	-0.1	7	4	12	SSSMini3-F2-B
Nch	FK330301		30	0.1	3	2		SSSMini3-F2-B
	FK3F0301		60	0.1	8	6		ML3-N4-B
Nch \times 2	FC694301	Dual	30	0.1	3	2		SSSMini3-F2-B
	FC694601		60	0.1	8	6		
Pch + Nch	FG694301		-30	-0.1	7	4	SSMini6-F3-B	
			30	0.1	3	2		

Applications

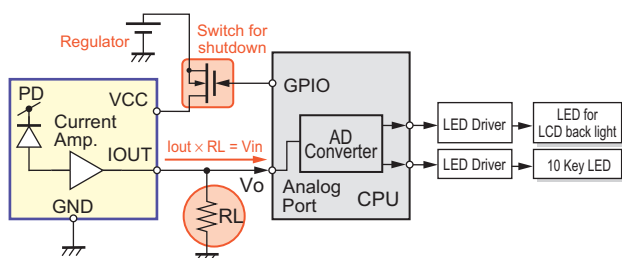

Image Sample

SSSMini3-F2-B



0.8 \times 1.2 \times 0.51

SSMini6-F3-B



1.2 \times 1.6 \times 0.55

Points on Appeal (Features)

- Low $R_{DS(on)}$
- Compact package
- Use halogen-free resin in all products

MEMO

A series of horizontal dashed lines for writing.

MEMO

A series of horizontal dashed lines for writing.

Precautions on the Sales of IPDs

- 1) The sale and/or the export of IPD products to customers located in certain countries is restricted by the Agreement made and executed by and between Power Integrations, Inc. and Panasonic Corporation. For details, refer to the following Attached table "IPD availability by customer."
- 2) IPD products purchased from our company, or its authorized agents, hereinafter referred to as our company, shall be used only for production purposes by those parties who have duly purchased IPD products. Those who have purchased IPD products shall not use such IPD products in unmodified form for re-sale, loan, or sample shipment for evaluation purposes to any other parties.
- 3) If a party who has duly purchased IPD products subcontracts its production to any other parties, including its subsidiaries or any other third parties inside and/or out of Japan, and the IPD products are consigned to such subcontracting parties thereat, such party is obligated to monitor and control the quantity of IPD products to prevent any of the aforementioned re-sale, loan or sample shipments from taking place.
- 4) In the event that any actual or threatened breach or violation of any of the above mentioned 2) or 3) has occurred or is about to occur, our company will hold all shipments of IPD products and may request the customer to disclose necessary documentation describing the status of our end-users and/or distribution channels.

Note) The products of MIP50□, MIP51□, and MIP7□□ are excluded from above-mentioned precautions, 1) to 3).

Attached table "IPD availability by customer"

Parts No.			Companies/areas to which products can be sold	Companies/areas to which products cannot be sold	Application
MIP0□□□ MIP3□□□ MIP9L□□	MIP1□□ MIP4□□□	MIP2□□□ MIP9A□□	· Japanese companies in Japan · Japanese companies in Asia (50% or more owned)	· Companies in European and American countries · Asian companies in Asia · Other local companies	· For power supply · For DC-DC converter
MIP52□ MIP816/826	MIP55□ MIP9E□□	MIP803/804	· Japanese companies in Japan · Japanese companies in Asia (50% or more owned) · Asian companies in Asia	· Companies in European and American countries · Other local companies	· For power supply · For EL driver · For LED lighting driver
MIP50□	MIP51□	MIP7□□	· No restrictions in terms of contract	· No restrictions in terms of contract	· For lamp driver/ car electronics accessories

Note) For details, contact our sales division.

The corporation names, logotype and product names written in this book are trademarks or registered trademarks of their corresponding corporations.

Inquiries URL : <https://www.semicon.panasonic.co.jp/semi-spt/general/?lang=en>

Request for your special attention and precautions in using the technical information and semiconductors described in this book

- (1) If any of the products or technical information described in this book is to be exported or provided to non-residents, the laws and regulations of the exporting country, especially, those with regard to security export control, must be observed.
- (2) The technical information described in this book is intended only to show the main characteristics and application circuit examples of the products. No license is granted in and to any intellectual property right or other right owned by Panasonic Corporation or any other company. Therefore, no responsibility is assumed by our company as to the infringement upon any such right owned by any other company which may arise as a result of the use of technical information described in this book.
- (3) The products described in this book are intended to be used for general applications (such as office equipment, communications equipment, measuring instruments and household appliances), or for specific applications as expressly stated in this book. Consult our sales staff in advance for information on the following applications: Special applications (such as for airplanes, aerospace, automotive equipment, traffic signaling equipment, combustion equipment, life support systems and safety devices) in which exceptional quality and reliability are required, or if the failure or malfunction of the products may directly jeopardize life or harm the human body. It is to be understood that our company shall not be held responsible for any damage incurred as a result of or in connection with your using the products described in this book for any special application, unless our company agrees to your using the products in this book for any special application.
- (4) The products and product specifications described in this book are subject to change without notice for modification and/or improvement. At the final stage of your design, purchasing, or use of the products, therefore, ask for the most up-to-date Product Standards in advance to make sure that the latest specifications satisfy your requirements.
- (5) When designing your equipment, comply with the range of absolute maximum rating and the guaranteed operating conditions (operating power supply voltage and operating environment etc.). Especially, please be careful not to exceed the range of absolute maximum rating on the transient state, such as power-on, power-off and mode-switching. Otherwise, we will not be liable for any defect which may arise later in your equipment. Even when the products are used within the guaranteed values, take into the consideration of incidence of break down and failure mode, possible to occur to semiconductor products. Measures on the systems such as redundant design, arresting the spread of fire or preventing glitch are recommended in order to prevent physical injury, fire, social damages, for example, by using the products.
- (6) Comply with the instructions for use in order to prevent breakdown and characteristics change due to external factors (ESD, EOS, thermal stress and mechanical stress) at the time of handling, mounting or at customer's process. When using products for which damp-proof packing is required, satisfy the conditions, such as shelf life and the elapsed time since first opening the packages.
- (7) This book may be not reprinted or reproduced whether wholly or partially, without the prior written permission of our company.

Semiconductor Business Division
Automotive & Industrial Systems Company
Panasonic Corporation

1 Kotari-yakemachi, Nagaokakyo City, Kyoto
617-8520, Japan
Tel : 81-75-951-8151

<http://www.semicon.panasonic.co.jp/en>