

### FEATURES

- Fixed and Adjustable Versions Available
- Output Current up to 500mA
- Very Low Quiescent Current
- Reverse Battery Protection
- Input-output Differential less than 0.6V
- Short Circuit Protection
- Internal Thermal Overload Protection
- Overvoltage Protection
- ON/OFF Pin

### APPLICATIONS

- Cellular Telephones
- Portable Consumer Equipment
- Portable (Notebook) Computers
- Battery Powered Systems
- Portable Instrumentation
- Radio Control Systems
- CD/DVD drives
- Automotive

### GENERAL DESCRIPTION

The AMS500 series consists of positive fixed and adjustable voltage regulators ideally suited for use in battery-powered systems. These devices feature very low quiescent current of 0.8mA or less when supplying 50mA loads. This unique characteristic and the low input-output differential required for proper regulation (0.2V for output currents of 100mA) make the AMS500 ideal to use for standby power systems.

Internal circuitry of AMS500 is protected from input fault conditions caused by input voltages that exceed maximum rated input voltage. During line transients, when the input voltage to the regulator can momentarily exceed the specified maximum operating voltage, the regulator will automatically shut down to protect both internal circuits and the load. The AMS500 series also includes internal current limiting, thermal shutdown.

The AMS500 is offered in 3 lead TO-92, SOT-89 and 5 leads SOT-23 packages.

### ORDERING INFORMATION

| OUTPUT<br>VOLTAGE | PACKAGE TYPE |           |            | TEMP.<br>RANGE |
|-------------------|--------------|-----------|------------|----------------|
|                   | 3L TO-92     | SOT-89    | SOT-23-5   |                |
| FIXED             | AMS500N-X    | AMS500L-X | AMS500M1-X | IND            |
| ADJ.              |              |           | AMS500M1   | IND            |

X = 2.0V, 2.5V, 3.0V, 3.3V, 3.5V, 4.0V, 5.0V.

### PIN CONNECTIONS

**TO-92**  
Plastic Package (N)

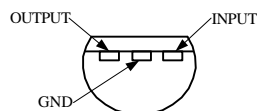

**Bottom View**

**SOT-89**  
(L)

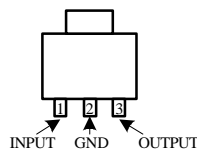

**Top View**

**5 Lead SOT-23**  
(M1)

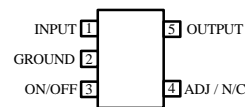

**Top View**

## ABSOLUTE MAXIMUM RATINGS (Note 1)

|                                     |                    |                                     |                 |
|-------------------------------------|--------------------|-------------------------------------|-----------------|
| Input Voltage                       |                    | Maximum Junction Temperature        | +125°C          |
| Operating                           | 25V                | Storage Temperature                 | -65°C to +150°C |
| Overvoltage Protection              | 26V to 40V         | Lead Temperature (Soldering 10 sec) | 230°C           |
| Internal Power Dissipation (Note 4) | Internally Limited | ESD                                 | 2000V           |

## ELECTRICAL CHARACTERISTICS

Electrical Characteristics at  $V_{IN}=6.3V$ ,  $I_O=5mA$ ,  $T_J=25^\circ C$ ,  $C_2 = 22\mu F$  unless otherwise specified.

| PARAMETER                            | CONDITIONS   | AMS500-X |           |      | Units       |
|--------------------------------------|--|----------|-----------|------|-------------|
|                                      |  | Min.     | Typ.      | Max. |             |
| <b>Fixed Output Voltage Versions</b> |  |          |           |      |             |
| Output Voltage Tolerance             |  | -4.0     |           | +4.0 | %           |
|                                      | $6.3V \leq V_{IN} \leq 25V$ , $I_O=100mA$                            |          | $\pm 5.0$ |      | %           |
| Line Regulation                      | $6V \leq V_{IN} \leq 15V$  |          | 5         | 10   | mV          |
|                                      | $15V \leq V_{IN} \leq 25V$   |          | 5         | 30   | mV          |
| Load Regulation                      | $5mA \leq I_O \leq 100mA$  |          | 5         | 25   | mV          |
|                                      | $5mA \leq I_O \leq 200mA$  |          | 15        | 40   | mV          |
|                                      | $5mA \leq I_O \leq 350mA$  |          | 20        | 60   | mV          |
|                                      | $5mA \leq I_O \leq 500mA$  |          | 20        | 75   | mV          |
| Dropout Voltage                      | $I_O = 100mA$  |          | 0.25      | 0.40 | mV          |
|                                      | $I_O = 200mA$  |          | 0.40      | 0.50 | mV          |
|                                      | $I_O = 350mA$  |          | 0.45      | 0.60 | mV          |
|                                      | $I_O = 500mA$  |          | 0.55      | 0.80 | mV          |
| Quiescent Current                    | $I_O \leq 10mA$ ,  |          | 0.2       | 0.5  | mA          |
|                                      | $I_O = 100mA$  |          | 2         | 4    | mA          |
|                                      | $I_O \leq 200mA$   |          | 5         | 10   | mA          |
|                                      | $I_O = 350mA$  |          | 12        |      | mA          |
| Output Noise Voltage                 | 10Hz-100kHz, $C_{OUT} = 100\mu F$                                    |          | 50        |      | $\mu V$ rms |
| Output Bypass Capacitor              | ESR=0.1 to 10 $\Omega$   |          | 10        |      | $\mu F$     |
| Ripple Rejection                     | $f_o = 120Hz$  |          | 80        |      | dB          |
| Maximum Operational Input Voltage    |  | 25       | 28        |      | V           |
| Maximum Line Transient               | $R_L = 500\Omega$ , $V_O \leq 5.5V$<br>$T = 1ms$ , $\tau \leq 100ms$ | 35       | 40        |      | V           |

## ELECTRICAL CHARACTERISTICS

Electrical Characteristics at  $V_{IN}=6V$ ,  $V_{OUT}=3V$   $I_O=5mA$ ,  $T_J=25^\circ C$ ,  $R1=27k$ ,  $C2=2\mu F$  unless otherwise specified.

| PARAMETER                         | CONDITIONS<br>(Note 2)  | AMS500-X     |              |              | Units           |
|-----------------------------------|---|--------------|--------------|--------------|-----------------|
|                                   |   | Min.         | Typ.         | Max.         |                 |
| <b>Adjustable Version</b>         |   |              |              |              |                 |
| Reference Voltage                 |   | 1.20         | 1.235        | 1.27         | V               |
|                                   | $I_O \leq 100$ mA, $-40^\circ C \leq T_J \leq 125^\circ C$ ,<br>R1=27k, Measured from $V_{OUT}$ to Adj. Pin | <b>1.180</b> | <b>1.235</b> | <b>1.290</b> | V               |
| Output Voltage Range              |   | 2            |              | 24           | V               |
| Line Regulation                   | $6V \leq V_{IN} \leq 25V$   |              | .02          | 1.5          | mV/V            |
| Load Regulation                   | $5mA \leq I_O \leq 100$ mA  |              | 0.3          | 0.5          | %               |
|                                   | $5mA \leq I_O \leq 200$ mA  |              | 0.5          | 1            | %               |
|                                   | $5mA \leq I_O \leq 350$ mA  |              | 1.0          | 1.5          | %               |
|                                   | $5mA \leq I_O \leq 500$ mA  |              | 1.0          | 2.0          | %               |
| Dropout Voltage                   | $I_O = 100$ mA  |              | 0.05         | 0.40         | V               |
|                                   | $I_O = 200$ mA  |              | 0.3          | 0.50         | V               |
|                                   | $I_O = 350$ mA  |              | 0.5          | 0.60         | V               |
|                                   | $I_O = 500$ mA  |              | 0.6          | 0.80         | V               |
| Quiescent Current                 | $I_O = 0$ mA,   |              | 0.18         | 0.5          | mA              |
|                                   | $I_O = 100$ mA  |              | 2.0          | 4            | mA              |
|                                   | $I_O = 200$ mA  |              | 5.0          | 10           | mA              |
|                                   | $I_O = 350$ mA  |              | 12           |              | mA              |
| Output Noise Voltage              | 10Hz-100kHz   |              | 100          |              | $\mu V_{rms}/V$ |
| Output Bypass Capacitor           | ESR=0.1 to 10 $\Omega$  |              | 10           |              | $\mu F$         |
| Long Term Stability               | T = 1000hr  |              | 0.4          |              | %/1000hr        |
| Ripple Rejection                  | $f_O = 120$ Hz  |              | 0.02         |              | dB              |
| Maximum Operational Input Voltage |   | 21           | 22           |              | V               |
| Maximum Line Transient            | $I_O = 10$ mA, Reference Voltage $\leq 1.5$ V<br>T = 1ms, $\tau \leq 100$ ms                                | 35           | 40           |              | V               |
| On/Off Threshold Voltage          | $V_O = 3V$  |              | 1.8          | 1.5          | V               |
|                                   |   | 2.5          | 2.0          |              | V               |
| On/Off Threshold Current          | $V_{OFF} = 2.4V$  |              | 35           | 60           | $\mu A$         |

**Note 1:** Absolute Maximum Ratings are limits beyond which damage to the device may occur. For guaranteed performance limits and associated test conditions, see the Electrical Characteristics tables.

**Note 2:** To ensure constant junction temperature, low duty cycle pulse testing is used.

**Note 3:** Limits appearing in **boldface** type apply over the entire junction temperature range for operation. Limits appearing in normal type apply for  $T_A = T_J = 25^\circ C$ .

**Note 4:** The maximum allowable power dissipation is a function of the maximum junction temperature  $T_J(MAX)$ , the junction-to ambient thermal resistance  $\theta_{JA}$  and the ambient temperature  $T_A$ . The maximum allowable power dissipation at any ambient temperature is calculated using:

$$P(MAX) = \frac{T_J(MAX) - T_A}{\theta_{JA}}$$

Where the value of the junction-to-ambient thermal resistance are as follows: 195 $^\circ C/W$  for TO-92 (N), 110 $^\circ C/W$  for SOT-89 (L) and 220 $^\circ C/W$  for 5 lead SOT-23.

## TYPICAL PERFORMANCE CHARACTERISTICS

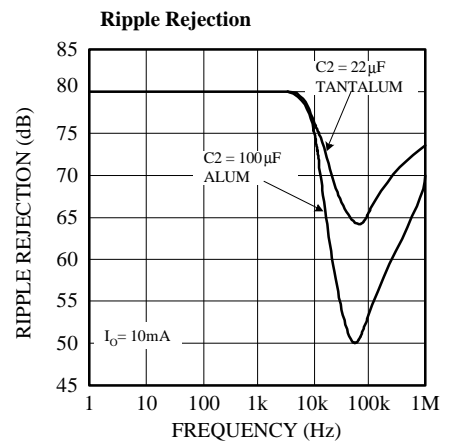
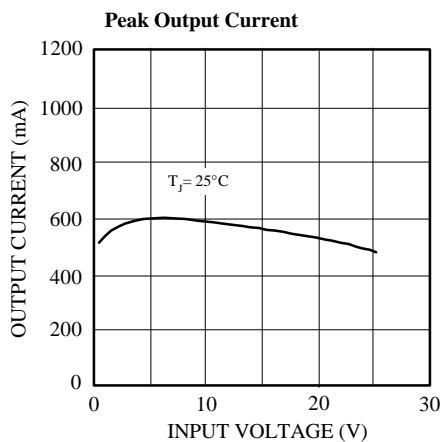
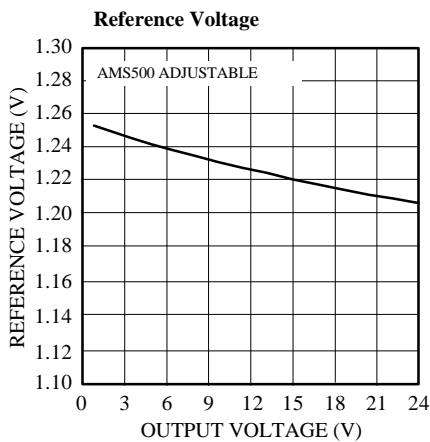
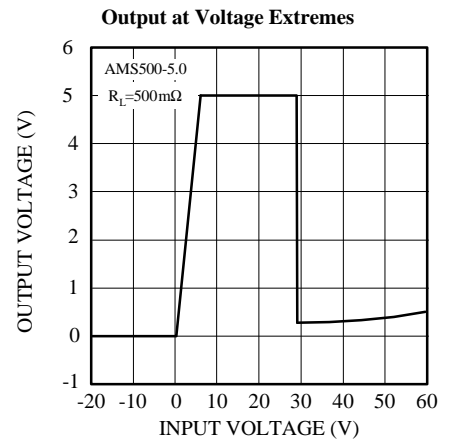
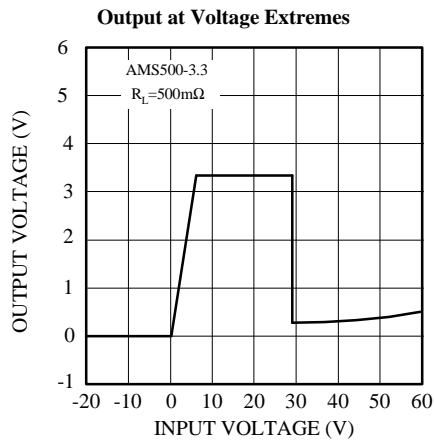
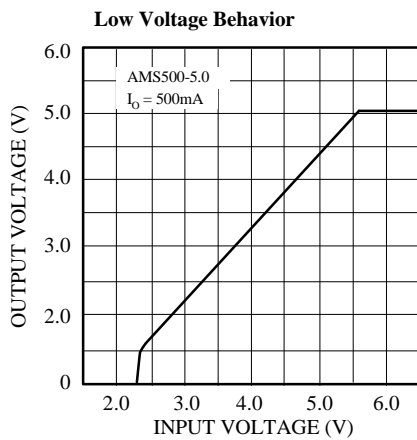
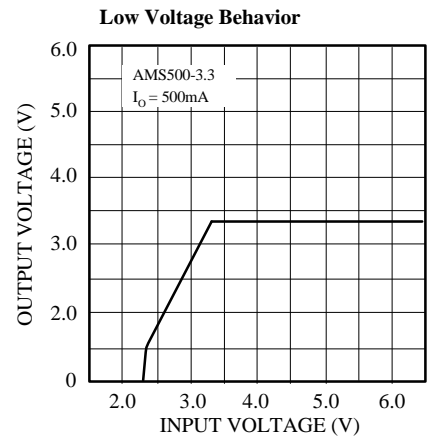
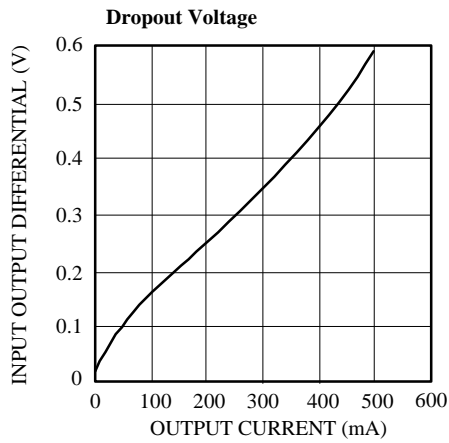
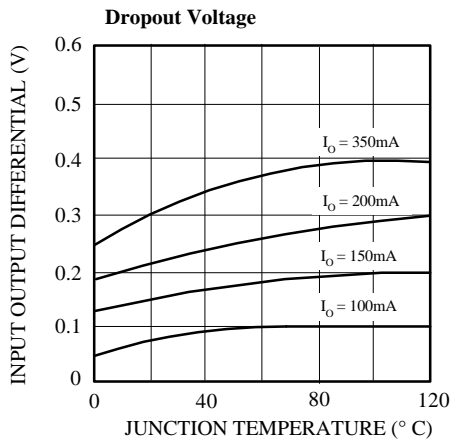

## TYPICAL PERFORMANCE CHARACTERISTICS (Continued)

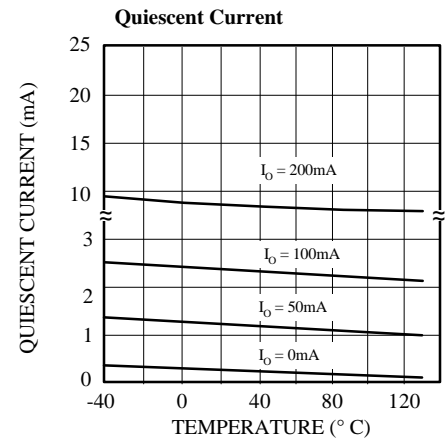
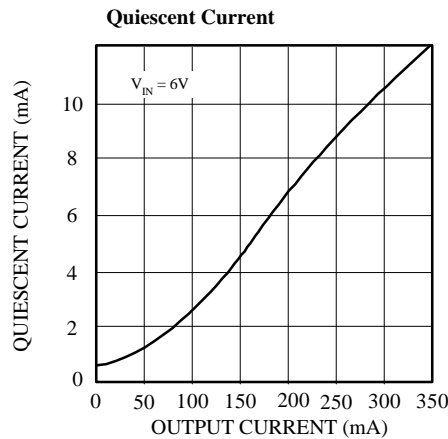
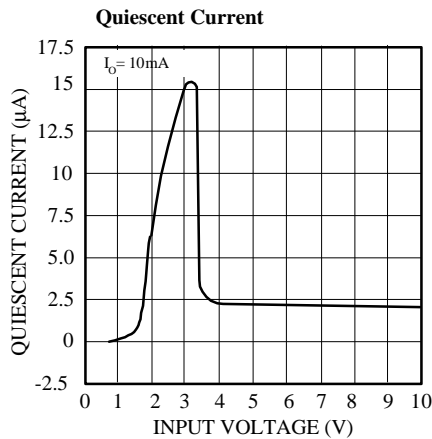

## APPLICATION NOTES

### Definition of Terms

**Dropout Voltage:** The input-output voltage differential at which the circuit stops to regulate against further reduction in input voltage. Measured when the output voltage has dropped 100mV from the nominal voltage obtained at 1V input, dropout voltage is dependent upon load current and junction temperature.

**Input Voltage:** The DC voltage applied to the input terminal with respect to ground. **Input-Output Differential:** The voltage difference between the unregulated input voltage and the regulated output voltage for which the regulator will regulate.

**Line Regulation:** The change in output voltage for a change in the input voltage. The line regulation is measured under conditions of low dissipation or by using low duty cycle pulse testing such that the average chip temperature is not significantly affected.

**Load Regulation:** The change in output voltage for a change in load current at constant chip temperature.

**Long term stability:** Output voltage stability under accelerated life-test conditions after 1000 hours with maximum rated voltage and junction temperature.

**Output Noise Voltage:** The rms AC voltage at the output, with constant load and no input ripple, measured over a specified frequency range.

**Quiescent Current:** That part of the positive input current that does not contribute to the positive load current. The regulator ground lead current.

**Ripple Rejection:** The ratio of the peak-to-peak input ripple voltage to the peak-to-peak output ripple voltage at specified frequency.

**Temperature Stability of V<sub>O</sub>:** The percentage change in output voltage for a thermal variation from room temperature to either temperature extreme.

### External capacitor

The AMS500 series require an output capacitor of 10µF or greater to ensure device stability. Without the capacitor the device may oscillate

Most type of tantalum or electrolytic capacitor can be used in the applications. A critical characteristic of the capacitors is an ESR value of 5Ω or less and a resonant frequency above 500kHz. The value of this capacitor can be increased without limits. For higher loads, the value of the capacitor should be increased, specially when the output voltage is set for 2.5V or less. The AMS500 lowest fixed output voltage value is 2.0V

### Typical application circuit (adjustable output)

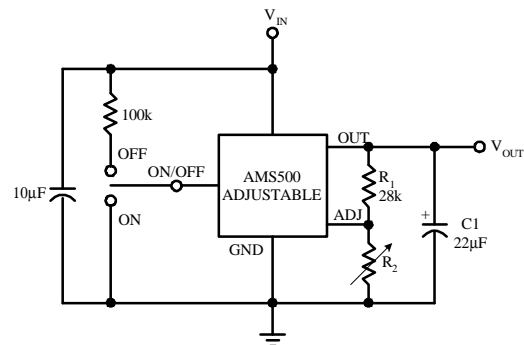

### Minimum Load

In circuits using the fixed output voltage versions, minimum load is not required. For circuits using the adjustable device, the value of R1 and R2 should be chosen such, that a current of approximately 40µA flows through the network. The reference voltage (1.235V) is measured between the adjust pin and V<sub>OUT</sub>. The output voltage can be set by the two resistors R1 and R2 using the following equation:

$$V_O = V_{REF} \left( \frac{R_1 + R_2}{R_1} \right)$$

The value of R1 is recommended to be between 25kΩ to 30 kΩ, and the value of R2 will set the output voltage.



**PACKAGE DIMENSIONS** inches (millimeters) unless otherwise noted (Continued).

## 5 LEAD SOT-23 PLASTIC PACKAGE (M1)

