

FEATURES

- Stable with low ESR Output Ceramic Capacitors
- Up to 95% Efficiency
- 2A Continuous Output Current
- Wide 4.75V to 20V Operating Input Range
- Fixed 480kHz Frequency
- Thermal Shutdown
- Cycle-by-cycle + hiccup Over Current Protection
- Under Voltage Lockout
- Frequency Synchronization Input
- Operating Temperature: -40°C to 125°C
- Available in an 8-Pin SO Package

APPLICATIONS

- Battery Chargers
- Portable (Notebook) Computers
- Industrial power supply
- Point of regulation for high performance electronics
- Consumer Electronics
- Audio Power Amplifiers
- Distributed Power Systems
- Pre-Regulator for Linear Regulators
- LCD TVs and LCD monitors

GENERAL DESCRIPTION

The AMS4155 is a monolithic step down switch mode converter with a built in internal power Switch Transistor. It achieves 2A continuous output current over a wide input supply range with excellent load and line regulation. Current mode operation provides fast transient response and eases loop stabilization. Fault condition protection includes cycle-by-cycle current limiting and thermal shutdown. In shutdown mode the regulator draws 17 μ A of supply current.

ORDERING INFORMATION

OUTPUT	PACKAGE TYPE	TEMP. RANGE
VOLTAGE	8 Lead SOIC	
Adjustable	AMS4155S	-25°C to 125°C

TYPICAL APPLICATION

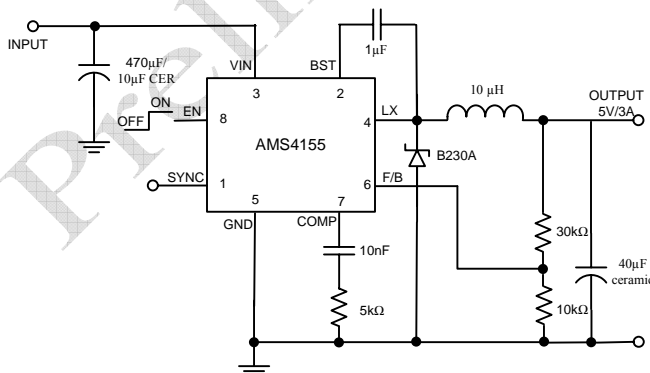

PIN CONNECTIONS

8L SOIC SO Package (S)

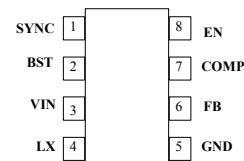

Top View

PIN DESCRIPTION

Pin Number	NAME	DESCRIPTION
1	SYNC	Synchronization Input. This pin is used to synchronize the internal oscillator frequency to an external source. Leave SYNC unconnected or connect to GND if unused.
2	BST	Bootstrap. This capacitor is needed to drive the power switch above the supply voltage. It is connected between LX and BST pins to form a floating supply across the power switch driver. The voltage across Cbst is about 5V and is supplied by the internal Vcc supply when LX pin voltage is low.
3	VIN	Supply Voltage. The AMS4155 operates from a +4.75V to +23V unregulated input. Cin is needed to prevent large voltage spikes from appearing at the input power supply.
4	LX	This connects the inductor to the internal Switch
5	GND	Ground Pin connected to PCB ground plane. This pin is also the ground for internal voltage reference.
6	FB	Feedback. A resistor network of two resistors is used to set-up the output voltage connected between Output to GND. The node between the two resistors is connected to Feedback pin.
7	COMP	Compensation. This node is the output of the transconductance error amplifier and the input to the current comparator. Frequency compensation is done at this node by connecting a series R-C to ground.
8	ENABLE	Enable. A voltage greater than 2.495V at this pin enables device operation.

ABSOLUTE MAXIMUM RATINGS

V _{IN}	28V	LX	-1V to +28V
F/B	-0.3V to +6V	COMP	-0.3V to +6V
EN	-0.3V to +6V	SYNC	-0.3v to +6V
BST	VLX + 6V		

Junction Temperature	+150°C
Storage Temperature	-65°C to +150°C
Lead temperature 1,6 mm (1/16 inch) from case for 10 seconds	260°C

ELECTRICAL CHARACTERISTICS

Electrical Characteristics at T_A = 25 °C and V_{IN} = 12V (unless otherwise noted).

PARAMETER	TEST CONDITIONS	AMS4155			Units
		Min.	Typ.	Max.	
Feedback Voltage	4.75V ≤ V _{IN} ≤ 20V, V _{COMP} < 2V	1.215	1.255	1.285	V
Switch On Resistance			0.18		Ω
Switch Leakage	V _{EN} = 0V; VLX = 0V		0	10	μA
Current Limit ⁽¹⁾		3.4	4	6	A
Current Amplifier Gain			1.9		A/V
Error Amplifier Voltage Gain			400		V/V
Error Amplifier Transconductance	ΔI _C = ± 10μA		730		μA/V
Oscillator Frequency		420	460	500	KHz
Sync Frequency	Sync Drive 0.5V to 2.7V	0.460		1.1	MHz
Maximum Duty Cycle	V _{FB} = 1.0V		85		%
Minimum Duty Cycle	V _{FB} = 1.5V			3.2	%
Enable Threshold		2.2	2.475	2.55	V
Enable Hysteresis			220		mV
Enable Pull-up Current			0.7		μA
Under Voltage Lockout Threshold Rising		2.4	2.5	2.6	V
Under Voltage Lockout Threshold Hysteresis			200		mV
Supply Current (Shutdown)	V _{EN} ≤ 0.4V		17	25	μA
Supply Current (Quiescent)	V _{EN} ≥ 2.8V; V _{FB} = 1.5V		0.95	1.1	mA
Thermal Shutdown			153		°C

Note:

- Equivalent output current = 1.5A ≥ 50% Duty Cycle
2.0A ≤ 50% Duty Cycle
Assumes ripple current = 30% of load current.

TYPICAL PERFORMANCE CHARACTERISTICS

Light load start up

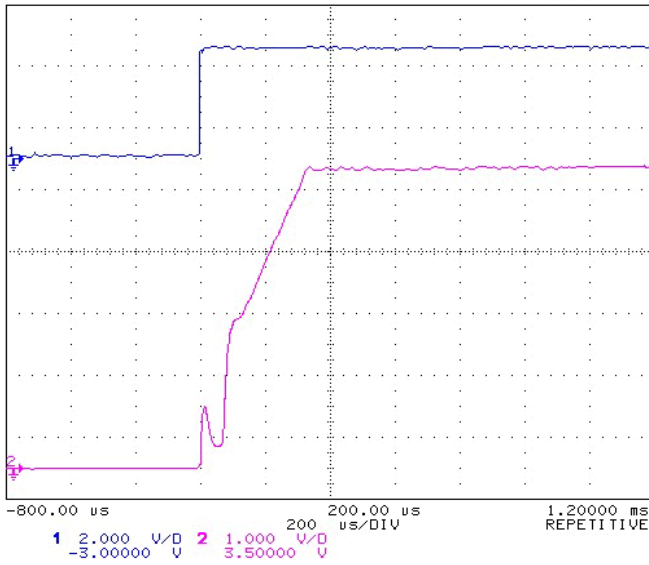

Full load start up

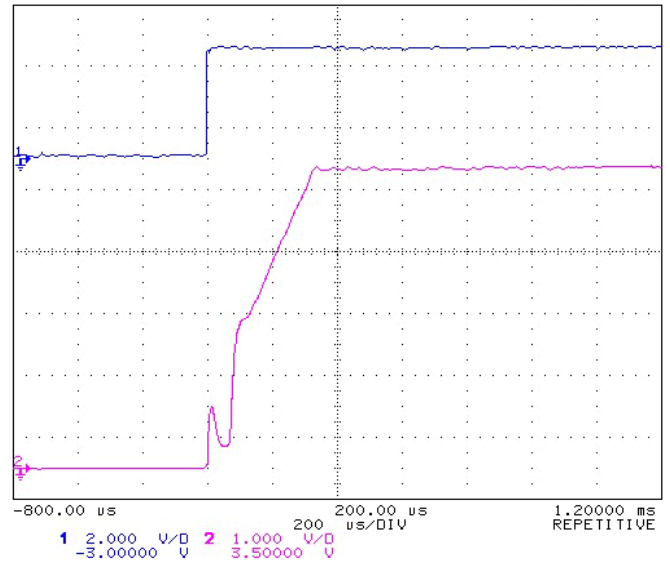

PWM rising edge

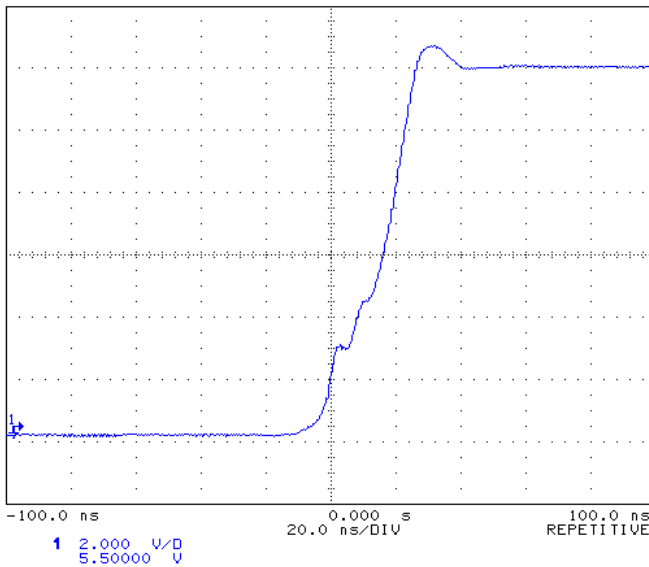

PWM Falling edge

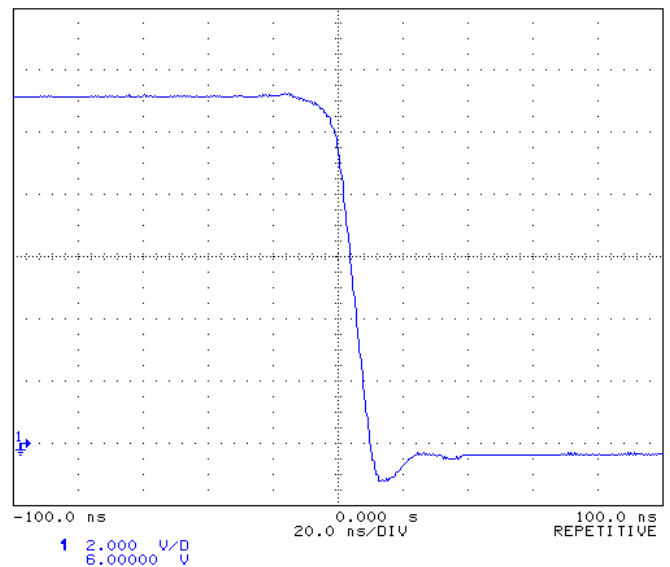

TYPICAL PERFORMANCE CHARACTERISTICS (continued)

0.5-3A transient on 5V output

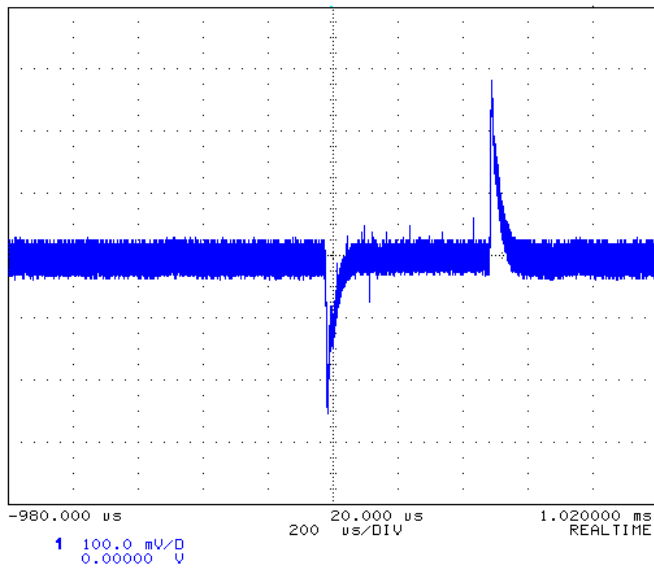

Full load Sat (reference = supply at IC)

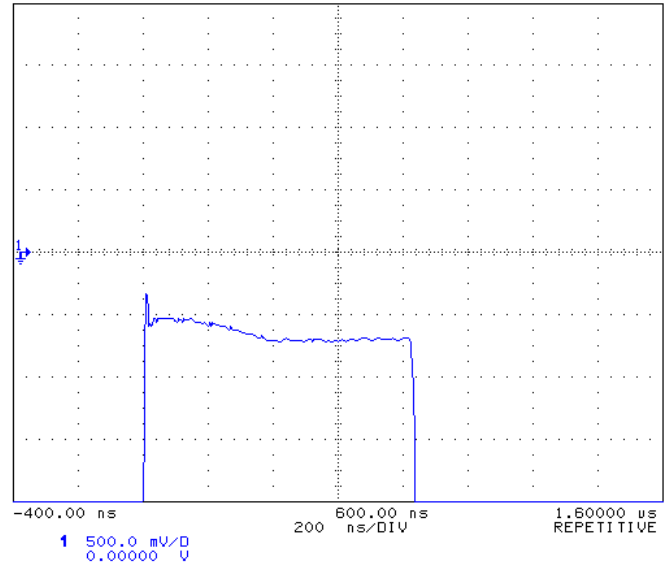

Typical waveform set at 3.3V output, 2A load and 12V input.

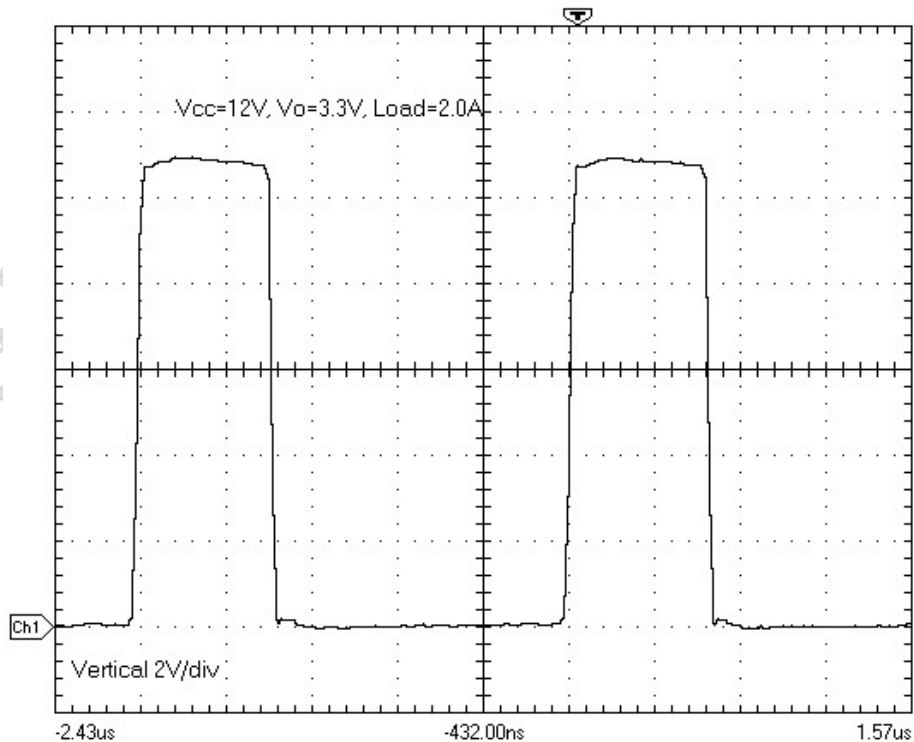

PACKAGE DIMENSIONS inches (millimeters) unless otherwise noted.

8 LEAD SOIC PLASTIC PACKAGE (S)

