

FEATURES

- Selectable 1× or 2× interpolation filter**
- Support input signal bandwidth up to 575 MHz**
- Very small inherent latency variation: <2 DAC clock cycles**
- Proprietary low spurious and distortion design**
 - 6-carrier GSM ACLR = 79 dBc at 200 MHz IF**
 - SFDR >85 dBc (bandwidth = 300 MHz) at zero IF**
- Flexible 16-bit LVDS interface**
 - Supports word and byte load**
- Multiple chip synchronization**
 - Fixed latency and data generator latency compensation**
- FIFO eases system timing and includes error detection**
- High performance, low noise PLL clock multiplier**
- Digital inverse sinc filter**
- Low power: 700 mW at 1230 MSPS**
- 72-lead LFCSP**

APPLICATIONS

- Wireless communications: 3G/4G and MC-GSM base stations, wideband repeaters, software defined radios**
- Wideband communications: point-to-point, LMDS/MMDS**
- Transmit diversity/MIMO**
- Instrumentation**
- Automated test equipment**

GENERAL DESCRIPTION

The **AD9139** is an 16-bit, high dynamic range digital-to-analog converter (DAC) that provides a sample rate of 1600 MSPS, permitting a multicarrier generation up to the Nyquist frequency. The **AD9139** TxDAC+® includes features optimized for wideband communication applications, including 1× and 2× interpolation, a delay locked loop (DLL) powered high speed interface, sample error detection, and parity detection. A 3-wire serial port interface provides for the programming/readback of many internal parameters. A full-scale output current can be programmed over a range of 9 mA up to 33 mA. The **AD9139** is available in a 72-lead LFCSP.

PRODUCT HIGHLIGHTS

1. 575 MHz achievable input signal bandwidth.
2. Advanced low spurious and distortion design techniques provide high quality synthesis of wideband signals from baseband to high intermediate frequencies.
3. Very small inherent latency variation simplifies both software and hardware design in the system. It allows easy multichip synchronization for most applications.
4. Low power architecture improves power efficiency.

FUNCTIONAL BLOCK DIAGRAM

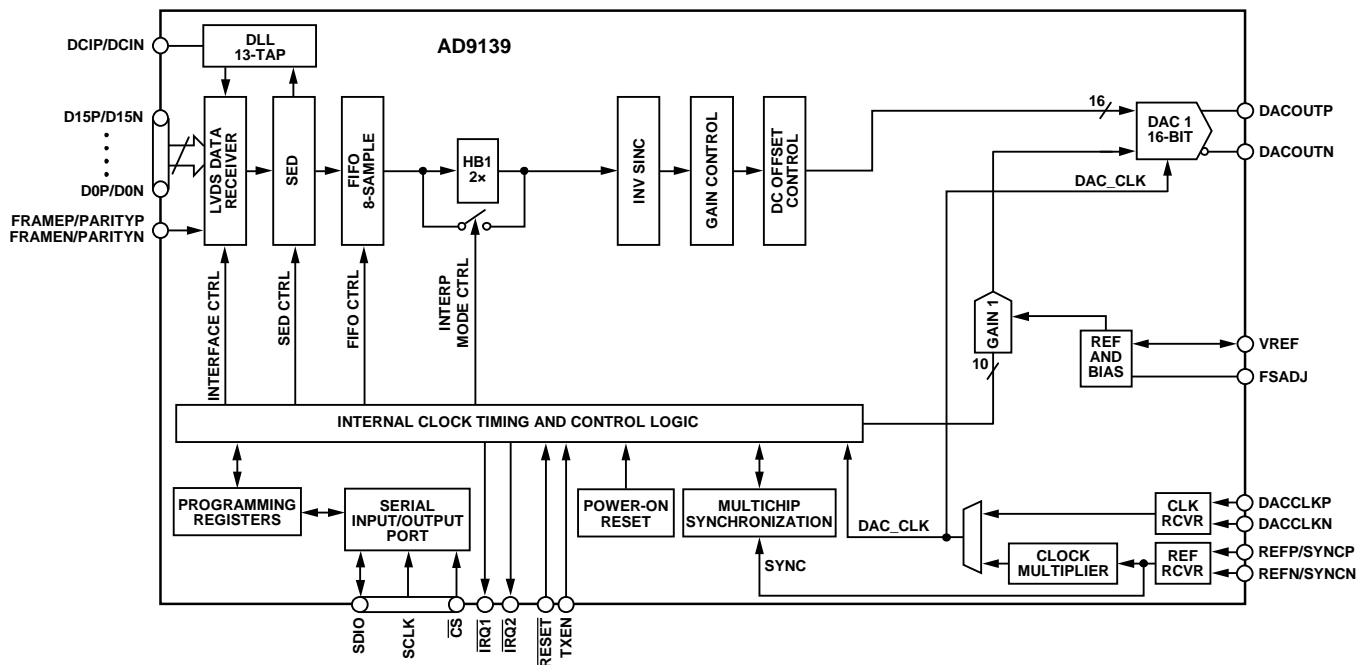

Figure 1.

Rev. 0

[Document Feedback](#)

Information furnished by Analog Devices is believed to be accurate and reliable. However, no responsibility is assumed by Analog Devices for its use, nor for any infringements of patents or other rights of third parties that may result from its use. Specifications subject to change without notice. No license is granted by implication or otherwise under any patent or patent rights of Analog Devices. Trademarks and registered trademarks are the property of their respective owners.

One Technology Way, P.O. Box 9106, Norwood, MA 02062-9106, U.S.A.
 Tel: 781.329.4700 ©2013 Analog Devices, Inc. All rights reserved.
[Technical Support](#) www.analog.com

TABLE OF CONTENTS

Features	1	Multidevice Synchronization and Fixed Latency.....	29
Applications.....	1	Very Small Inherent Latency Variation	29
General Description	1	Further Reducing the Latency Variation.....	29
Product Highlights	1	Synchronization Implementation	29
Functional Block Diagram	1	Synchronization Procedures	30
Revision History	3	Interrupt Request Operation	32
Specifications.....	4	Interrupt Working Mechanism	32
DC Specifications	4	Interrupt Service Routine.....	32
Digital Specifications	5	Temperature Sensor	33
Latency Variation Specifications	6	DAC Input Clock Configurations	34
AC Specifications.....	6	Driving the DACCLK and REFCLK Inputs	34
Operating Speed Specifications	6	Direct Clocking	34
Absolute Maximum Ratings	7	Clock Multiplication	34
Thermal Resistance	7	PLL Settings	35
ESD Caution.....	7	Configuring the VCO Tuning Band.....	35
Pin Configuration and Function Descriptions.....	8	Automatic VCO Band Select	35
Typical Performance Characteristics	11	Manual VCO Band Select	35
Terminology	15	PLL Enable Sequence.....	35
Serial Port Operation	16	Analog Outputs.....	36
Data Format	16	Transmit DAC Operation.....	36
Serial Port Pin Descriptions.....	16	Interfacing to Modulators	37
Serial Port Options.....	16	Reducing LO Leakage and Unwanted Sidebands	38
Data Interface	18	Start-Up Routine	39
LVDS Input Data Ports	18	Device Configuration Register Map and Description.....	40
Word Interface Mode.....	18	SPI Configure Register	42
Byte Interface Mode	18	Power-Down Control Register	42
Data Interface Configuration Options	18	Interrupt Enable 0 Register	42
DLL Interface Mode.....	18	Interrupt Enable 1 Register	42
Parity	21	Interrupt Flag 0 Register.....	43
SED Operation.....	21	Interrupt Flag 1 Register.....	43
SED Example.....	22	Interrupt Select 0 Register.....	43
Delay Line Interface Mode	22	Interrupt Select 1 Register.....	44
FIFO Operation	24	Frame Mode Register.....	44
Resetting the FIFO	25	Data Control 0 Register	44
Serial Port Initiated FIFO Reset	25	Data Control 1 Register	44
Frame Initiated FIFO Reset.....	25	Data Control 2 Register	45
Digital Datapath.....	27	Data Control 3 Register	45
Interpolation Filters	27	Data Status 0 Register	45
Inverse Sinc Filter	28	DAC Clock Receiver Control Register	46
Digital Function Configuration.....	28	Reference Clock Receiver Control Register	46

PLL Control Register	46	Gain Step Control0 Register	52
PLL Control Register	47	Gain Step Control1 Register	52
PLL Control Register	47	TX Enable Control Register	52
PLL Status Register	47	DAC Output Control Register	53
PLL Status Register	48	DLL Cell Enable 0 Register	53
DAC FS Adjust LSB Register	48	DLL Cell Enable 1 Register	53
DAC FS Adjust MSB Register	48	SED Control Register	53
Die Temperature Sensor Control Register	48	SED Pattern S0 Low Bits Register	54
Die Temperature LSB Register	48	SED Pattern S0 High Bits Register	54
Die Temperature MSB Register	49	SED Pattern S1 Low Bits Register	54
Chip ID Register	49	SED Pattern S1 High Bits Register	54
Interrupt Configuration Register	49	SED Pattern S2 Low Bits Register	54
Sync CTRL Register	49	SED Pattern S2 High Bits Register	54
Frame Reset CTRL Register	49	SED Pattern S3 Low Bits Register	54
FIFO Level Configuration Register	50	SED Pattern S3 High Bits Register	55
FIFO Level Readback Register	50	Parity Control Register	55
FIFO CTRL Register	50	Parity Error Rising Edge Register	55
Data Format Select Register	51	Parity Error Falling Edge Register	55
Datapath Control Register	51	Version Register	55
Interpolation Control Register	51	Packaging and Ordering Information	56
Power-Down Data Input 0 Register	51	Outline Dimensions	56
DAC_DC_OFFSET0 Register	51	Ordering Guide	56
DAC_DC_OFFSET1 Register	51		
DAC_GAIN_ADJ Register	52		

REVISION HISTORY

10/13—Revision 0: Initial Version

SPECIFICATIONS

DC SPECIFICATIONS

T_{MIN} to T_{MAX} , AVDD33 = 3.3 V, DVDD18 = 1.8 V, CVDD18 = 1.8 V, I_{OUTFS} = 20 mA, maximum sample rate, unless otherwise noted.

Table 1.

Parameter	Test Conditions/Comments	Min	Typ	Max	Unit
RESOLUTION			16		Bits
ACCURACY					
Differential Nonlinearity (DNL)			±2.1		LSB
Integral Nonlinearity (INL)			±3.7		LSB
MAIN DAC OUTPUT					
Offset Error		-0.001	0	+0.001	% FSR
Gain Error	With internal reference	-3.2	+2	+4.7	% FSR
Full-Scale Output Current	10 kΩ external resistor between FSADJ and AVSS	19.06	19.8	20.6	mA
Output Compliance Range		-1.0		+1.0	V
Output Resistance			10		MΩ
Gain DAC Monotonicity			Guaranteed		
Settling Time to Within ±0.5 LSB			20		ns
MAIN DAC TEMPERATURE DRIFT					
Offset			0.04		ppm/°C
Gain			100		ppm/°C
Reference Voltage			30		ppm/°C
REFERENCE					
Internal Reference Voltage		1.17		1.19	V
Output Resistance			5		kΩ
ANALOG SUPPLY VOLTAGES					
AVDD33		3.13	3.3	3.47	V
CVDD18		1.7	1.8	1.9	V
DIGITAL SUPPLY VOLTAGES					
DVDD18		1.7	1.8	1.9	V
DVDD18 Variation over Operating Conditions ¹		-2.5%		+2.5%	V
POWER CONSUMPTION					
1× Mode	$f_{DAC} = 614$ MSPS		440		mW
	$f_{DAC} = 1230$ MSPS		700		mW
2× Mode	$f_{DAC} = 800$ MSPS		670		mW
	$f_{DAC} = 1600$ MSPS		1150		mW
Phase-Locked Loop			70		mW
Inverse Sinc	$f_{DAC} = 1230$ MSPS		60		mW
Reduced Power Mode (Power-Down)				57.3	mW
AVDD33 Current				0.4	mA
CVDD18 Current				26.6	mA
DVDD18 Current				4.5	mA
OPERATING RANGE		-40	+25	+85	°C

¹ This parameter specifies the maximum allowable variation of DVDD18 over operating conditions compared with the DVDD18 presented to the device at the time the data interface DLL is enabled.

DIGITAL SPECIFICATIONS

T_{MIN} to T_{MAX} , $AVDD33 = 3.3$ V, $DVDD18 = 1.8$ V, $CVDD18 = 1.8$ V, $I_{OUTFS} = 20$ mA, maximum sample rate, unless otherwise noted.

Table 2.

Parameter	Symbol	Test Conditions/Comments	Min	Typ	Max	Unit
CMOS INPUT LOGIC LEVEL						
Input						
Logic High		DVDD18 = 1.8 V	1.2			V
Logic Low		DVDD18 = 1.8 V			0.6	V
CMOS OUTPUT LOGIC LEVEL						
Output						
Logic High		DVDD18 = 1.8 V	1.4			V
Logic Low		DVDD18 = 1.8 V			0.4	V
LVDS RECEIVER INPUTS		Data and frame inputs				
Input Voltage Range	V_{IA} or V_{IB}		825		1675	mV
Input Differential Threshold	V_{IDTH}		-175		+175	mV
Input Differential Hysteresis	V_{IDTHH} to V_{IDTHL}			20		mV
Receiver Differential Input Impedance	R_{IN}			100		Ω
DLL SPEED RANGE			250		575	MHz
DAC UPDATE RATE					1600	MSPS
DAC Adjusted Update Rate		1× interpolation			1150	MSPS
		2× interpolation			800	MSPS
DAC CLOCK INPUT (DACCLKP, DACCLKN)						
Differential Peak-to-Peak Voltage			100	500	2000	mV
Common-Mode Voltage		Self biased input, ac-coupled		1.25		V
REFCLK/SYNCCLK INPUT (REFP/SYNCP, REFN/SYNCN)						
Differential Peak-to-Peak Voltage			100	500	2000	mV
Common-Mode Voltage				1.25		V
Input Clock Frequency		$1.03 \text{ GHz} \leq f_{VCO} \leq 2.07 \text{ GHz}$			450	MHz
SERIAL PORT INTERFACE						
Maximum Clock Rate	SCLK		40			MHz
Minimum Pulse Width						
High	t_{PWH}				12.5	ns
Low	t_{PWL}				12.5	ns
SDIO to SCLK Setup Time	t_{DS}		1.5			ns
SDIO to SCLK Hold Time	t_{DH}		0.68			ns
\overline{CS} to SCLK Setup Time	t_{DCSB}		2.38	1.4		ns
\overline{CS} to SCLK Hold Time	t_{DCSB}		9.6			ns
SDIO to SCLK Delay	t_{DV}	Wait time for valid output from SDIO	11			ns
SDIO High-Z to \overline{CS}		Time for SDIO to relinquish the output bus	8.5			ns
SDIO LOGIC LEVEL						
Voltage Input High	V_{IH}		1.2	1.8		V
Voltage Input Low	V_{IL}			0	0.5	V
Voltage Output High	I_{IH}	With 2 mA loading	1.36		2	V
Voltage Output Low	I_{IL}	With 2 mA loading	0		0.45	V

LATENCY VARIATION SPECIFICATIONS

Table 3.

Parameter	Min	Typ	Max	Unit
DAC LATENCY ¹ VARIATION				
SYNC Off		1	2	DAC clock cycles
SYNC On		0	1	DAC clock cycles

¹ DAC latency is defined as the elapsed time from a data sample clocked at the input to the device until the analog output begins to change.

AC SPECIFICATIONS

T_{MIN} to T_{MAX}, AVDD33 = 3.3 V, DVDD18 = 1.8 V, CVDD18 = 1.8 V, I_{OUTFS} = 20 mA, maximum sample rate, unless otherwise noted.

Table 4.

Parameter	Test Conditions/Comments	Min	Typ	Max	Unit
SPURIOUS-FREE DYNAMIC RANGE (SFDR)	–14 dBFS single tone				
f _{DAC} = 737.28 MSPS	f _{OUT} = 200 MHz		85		dBc
Bandwidth (BW) = 125 MHz			80		dBc
BW = 270 MHz					
f _{DAC} = 983.04 MSPS	f _{OUT} = 200 MHz		85		dBc
BW = 360 MHz					
f _{DAC} = 1228.8 MSPS	f _{OUT} = 280 MHz		85		dBc
BW = 200 MHz			75		dBc
BW = 500 MHz					
TWO-TONE INTERMODULATION DISTORTION (IMD)	–12 dBFS each tone				
f _{DAC} = 737.28 MSPS	f _{OUT} = 200 MHz		80		dBc
f _{DAC} = 983.04 MSPS	f _{OUT} = 200 MHz		82		dBc
f _{DAC} = 1228.8 MSPS	f _{OUT} = 280 MHz		80		dBc
NOISE SPECTRAL DENSITY (NSD)	Eight-tone, 500 kHz tone spacing				
f _{DAC} = 737.28 MSPS	f _{OUT} = 200 MHz		–160		dBm/Hz
f _{DAC} = 983.04 MSPS	f _{OUT} = 200 MHz		–161.5		dBm/Hz
f _{DAC} = 1228.8 MSPS	f _{OUT} = 280 MHz		–164.5		dBm/Hz
W-CDMA ADJACENT CHANNEL LEAKAGE RATIO (ACLR)	Single carrier				
f _{DAC} = 983.04 MSPS	f _{OUT} = 200 MHz		81		dBc
f _{DAC} = 1228.8 MSPS	f _{OUT} = 20 MHz		83		dBc
	f _{OUT} = 280 MHz		80		dBc
W-CDMA SECOND (ACLR)	Single carrier				
f _{DAC} = 983.04 MSPS	f _{OUT} = 200 MHz		85		dBc
f _{DAC} = 1228.8 MSPS	f _{OUT} = 20 MHz		86		dBc
	f _{OUT} = 280 MHz		86		dBc

OPERATING SPEED SPECIFICATIONS

Table 5.

Interpolation Factor	DVDD18, CVDD18 = 1.8 V ± 5%		DVDD18, CVDD18 = 1.9 V ± 5% or 1.8 V ± 2%		DVDD18, CVDD18 = 1.9 V ± 2%	
	f _{DCI} (MSPS) Max	f _{DAC} (MSPS) Max	f _{DCI} (MSPS) Max	f _{DAC} (MSPS) Max	f _{DCI} (MSPS) Max	f _{DAC} (MSPS) Max
1×	575	1150	575	1150	575	1150
2×	350	1400	375	1500	400	1600

ABSOLUTE MAXIMUM RATINGS

Table 6.

Parameter	Rating
AVDD33 to GND	−0.3 V to +3.6 V
DVDD18, CVDD18 to GND	−0.3 V to +2.1 V
FSADJ, VREF, DACOUTP/DACOUTN, to GND	−0.3 V to AVDD33 + 0.3 V
D15P to D0P/D15N to D0N, FRAMEP/FRAMEN, DCIP/DCIN to GND	−0.3 V to DVDD18 + 0.3 V
DACCLKP/DACCLKN, REFP/SYNCP/REFN/SYCN to GND	−0.3 V to CVDD18 + 0.3 V
RESET, IRQ1, IRQ2, CS, SCLK, SDIO to GND	−0.3 V to DVDD18 + 0.3 V
Junction Temperature	125°C
Storage Temperature Range	−65°C to +150°C

Stresses above those listed under Absolute Maximum Ratings may cause permanent damage to the device. This is a stress rating only; functional operation of the device at these or any other conditions above those indicated in the operational section of this specification is not implied. Exposure to absolute maximum rating conditions for extended periods may affect device reliability.

THERMAL RESISTANCE

The exposed pad (EPAD) must be soldered to the ground plane (AVSS) for the 72-lead LFCSP. The EPAD provides an electrical, thermal, and mechanical connection to the board.

Typical θ_{JA} , θ_{JB} , and θ_{JC} values are specified for a 4-layer board in still air. Airflow increases heat dissipation, effectively reducing θ_{JA} and θ_{JB} .

Table 7. Thermal Resistance

Package	θ_{JA}	θ_{JB}	θ_{JC}	Unit	Conditions
72-Lead LFCSP	20.7	10.9	1.1	°C/W	EPAD soldered to ground plane

ESD CAUTION

ESD (electrostatic discharge) sensitive device. Charged devices and circuit boards can discharge without detection. Although this product features patented or proprietary protection circuitry, damage may occur on devices subjected to high energy ESD. Therefore, proper ESD precautions should be taken to avoid performance degradation or loss of functionality.

PIN CONFIGURATION AND FUNCTION DESCRIPTIONS

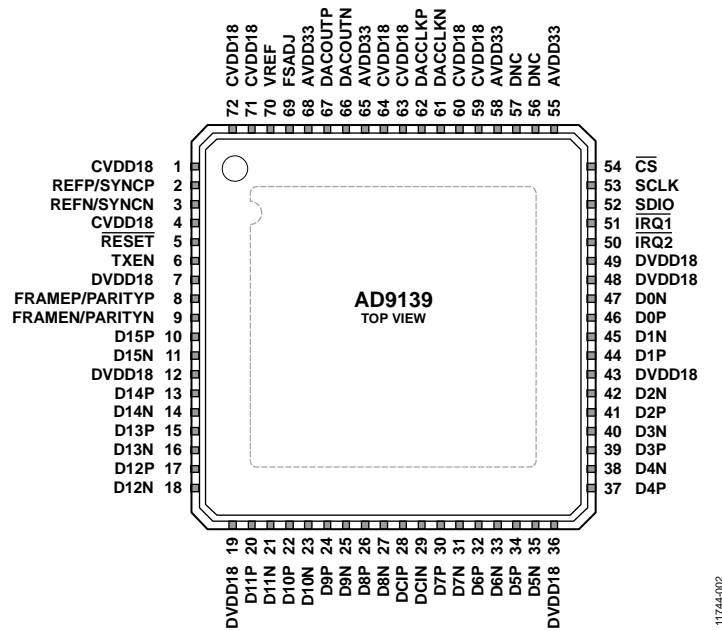

- NOTES**
1. DNC = DO NOT CONNECT. DO NOT CONNECT TO THIS PIN.
 2. THE EXPOSED PAD MUST BE SOLDERED TO THE GROUND PLANE (AVSS, DVSS, CVSS). THE EPAD PROVIDES AN ELECTRICAL, THERMAL, AND MECHANICAL CONNECTION TO THE BOARD.

Figure 2. Pin Configuration

Table 8. Pin Function Descriptions

Pin No.	Mnemonic	Description
1	CVDD18	1.8 V PLL Supply. CVDD18 supplies the power to the clock receivers, clock multiplier, and clock distribution.
2	REFP/SYNCP	PLL Reference Clock/Synchronization Clock Input, Positive.
3	REFN/SYNCN	PLL Reference Clock/Synchronization Clock Input, Negative.
4	CVDD18	1.8 V PLL Supply. CVDD18 supplies the power to the clock receivers, clock multiplier, and clock distribution.
5	RESET	Reset, Active Low. CMOS levels with respect to DVDD18. Recommended reset pulse length is 1 μs.
6	TXEN	Active High Transmit Path Enable. CMOS levels with respect to DVDD18. A low level on this pin triggers two selectable actions in the DAC. See Register 0x43 in Table 64 for details.
7	DVDD18	1.8 V Digital Supply. Pin 7 supplies power to the digital core, digital data ports, serial port input/output pins, RESET, IRQ1, and IRQ2.
8	FRAMEP/PARITYP	Frame/Parity Input, Positive.
9	FRAMEN/PARITYN	Frame/Parity Input, Negative.
10	D15P	Data Bit 15 (MSB), Positive.
11	D15N	Data Bit 15 (MSB), Negative.
12	DVDD18	1.8 V Digital Supply. Pin 12 supplies the power to the digital core and digital data ports, serial port input/output pins, RESET, IRQ1, and IRQ2.
13	D14P	Data Bit 14, Positive.
14	D14N	Data Bit 14, Negative.
15	D13P	Data Bit 13, Positive.
16	D13N	Data Bit 13, Negative.
17	D12P	Data Bit 12, Positive.
18	D12N	Data Bit 12, Negative.
19	DVDD18	1.8 V Digital Supply. Pin 19 supplies power to the digital core, digital data ports, serial port input/output pins, RESET, IRQ1, and IRQ2.
20	D11P	Data Bit 11, Positive.
21	D11N	Data Bit 11, Negative.
22	D10P	Data Bit 10, Positive.
23	D10N	Data Bit 10, Negative.

Pin No.	Mnemonic	Description
24	D9P	Data Bit 9, Positive.
25	D9N	Data Bit 9, Negative.
26	D8P	Data Bit 8, Positive.
27	D8N	Data Bit 8, Negative.
28	DCIP	Data Clock Input, Positive.
29	DCIN	Data Clock Input, Negative.
30	D7P	Data Bit 7, Positive.
31	D7N	Data Bit 7, Negative.
32	D6P	Data Bit 6, Positive.
33	D6N	Data Bit 6, Negative.
34	D5P	Data Bit 5, Positive.
35	D5N	Data Bit 5, Negative.
36	DVDD18	1.8 V <u>Digital Supply</u> . Pin <u>36</u> supplies the power to the digital core, digital data ports, serial port input/output pins, RESET, IRQ1, and IRQ2.
37	D4P	Data Bit 4, Positive.
38	D4N	Data Bit 4, Negative.
39	D3P	Data Bit 3, Positive.
40	D3N	Data Bit 3, Negative.
41	D2P	Data Bit 2, Positive.
42	D2N	Data Bit 2, Negative.
43	DVDD18	1.8 V <u>Digital Supply</u> . Pin <u>43</u> supplies the power to the digital core, digital data ports, serial port input/output pins, RESET, IRQ1, and IRQ2.
44	D1P	Data Bit 1, Positive.
45	D1N	Data Bit 1, Negative.
46	D0P	Data Bit 0, Positive.
47	D0N	Data Bit 0, Negative.
48	DVDD18	1.8 V <u>Digital Supply</u> . Pin <u>48</u> supplies the power to the digital core, digital data ports, serial port input/output pins, RESET, IRQ1, and IRQ2.
49	DVDD18	1.8 V <u>Digital Supply</u> . Pin <u>49</u> supplies the power to the digital core, digital data ports, serial port input/output pins, RESET, IRQ1, and IRQ2.
50	$\overline{\text{IRQ2}}$	Second Interrupt Request. Open-drain, active low output. Connect an external pull-up to DVDD18 through a 10 k Ω resistor.
51	$\overline{\text{IRQ1}}$	First Interrupt Request. Open-drain, active low output. Connect an external pull-up to DVDD18 through a 10 k Ω resistor.
52	SDIO	Serial Port Data Input/Output. CMOS levels with respect to DVDD18.
53	SCLK	Serial Port Clock Input. CMOS levels with respect to DVDD18.
54	$\overline{\text{CS}}$	Serial Port Chip Select. Active low (CMOS levels with respect to DVDD18).
55	AVDD33	3.3 V Analog Supply.
56	DNC	Do No Connect. Leave this pin floating.
57	DNC	Do No Connect. Leave this pin floating.
58	AVDD33	3.3 V Analog Supply.
59	CVDD18	1.8 V Clock Supply. CVDD18 supplies the power to the clock receivers and clock distribution.
60	CVDD18	1.8 V Clock Supply. CVDD18 supplies the power to the clock receivers and clock distribution.
61	DACCLKN	DAC Clock Input, Negative.
62	DACCLKP	DAC Clock Input, Positive.
63	CVDD18	1.8 V Clock Supply. CVDD18 supplies the power to the clock receivers and clock distribution.
64	CVDD18	1.8 V Clock Supply. CVDD18 supplies the power to the clock receivers and clock distribution.
65	AVDD33	3.3 V Analog Supply.
66	DACOUTN	DAC Current Output, Negative.
67	DACOUTP	DAC Current Output, Positive.
68	AVDD33	3.3 V Analog Supply.
69	FSADJ	Full-Scale Current Output Adjust. Place a 10 k Ω resistor from this pin to AVSS.
70	VREF	Voltage Reference. Nominally 1.2 V output. Decouple VREF to AVSS.
71	CVDD18	1.8 V Clock Supply. Pin 71 supplies power to the clock receivers, clock multiplier, and clock distribution.

Pin No.	Mnemonic	Description
72	CVDD18 EPAD	1.8 V Clock Supply. Pin 72 supplies power to the clock receivers, clock multiplier, and clock distribution. Exposed Pad. The exposed pad (EPAD) must be soldered to the ground plane (AVSS, DVSS, CVSS). The EPAD provides an electrical, thermal, and mechanical connection to the board.

TYPICAL PERFORMANCE CHARACTERISTICS

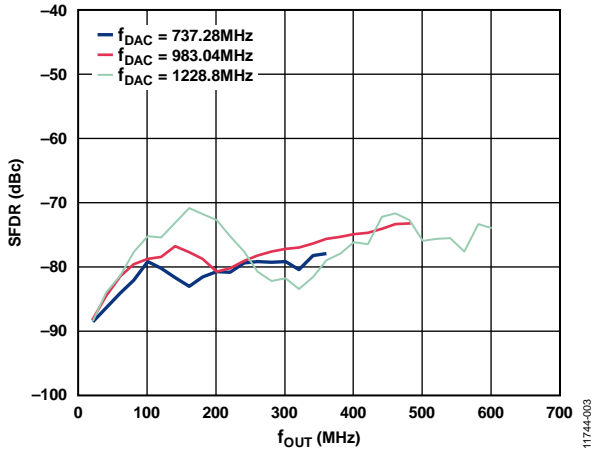

Figure 3. Single-Tone (0 dBFS) SFDR vs. f_{OUT} in the First Nyquist Zone over f_{DAC}

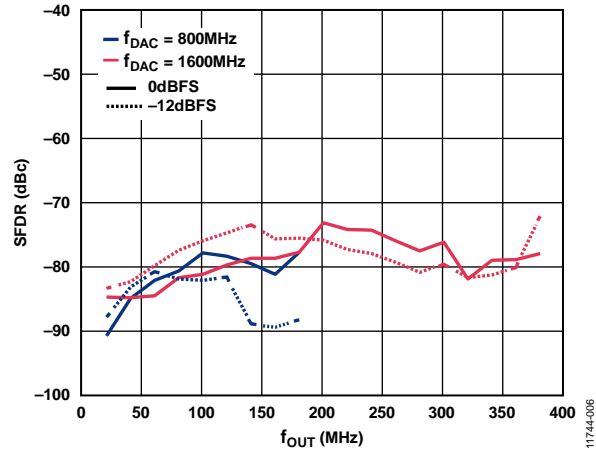

Figure 6. Single-Tone SFDR Excluding 2nd and 3rd Harmonics vs. f_{OUT} in the First Nyquist Zone over f_{DAC} and Digital Back Off

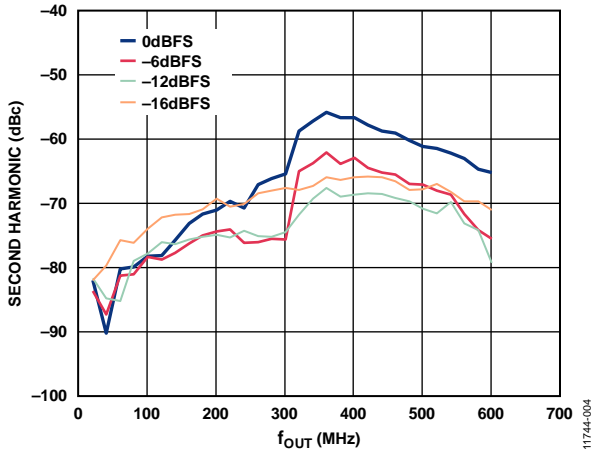

Figure 4. Single-Tone Second Harmonic vs. f_{OUT} in the First Nyquist Zone over Digital Back Off, $f_{DAC} = 1228.8$ MHz

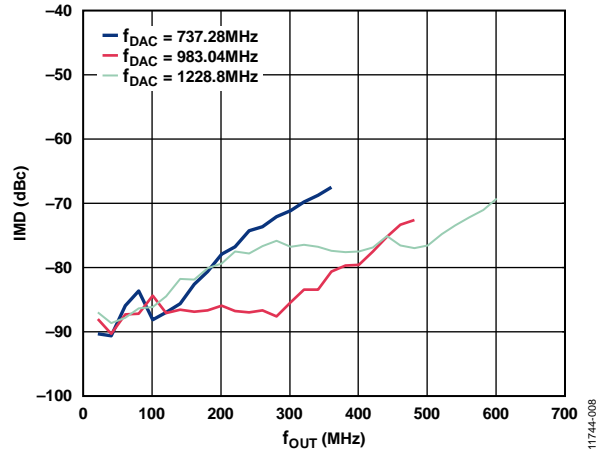

Figure 7. Two-Tone Third IMD vs. f_{OUT} over f_{DAC}

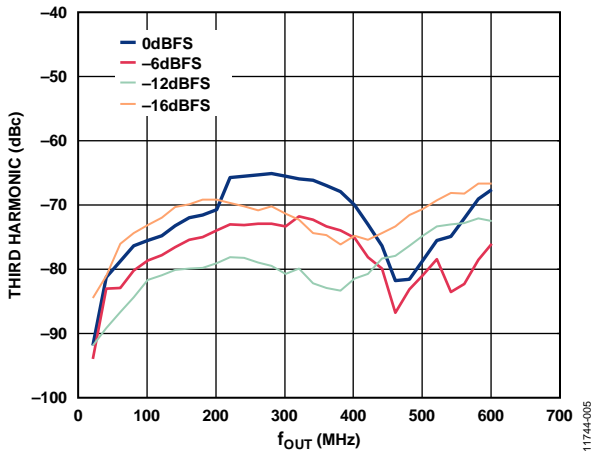

Figure 5. Single-Tone Third Harmonic vs. f_{OUT} in the First Nyquist Zone over Digital Back Off, $f_{DAC} = 1228.8$ MHz

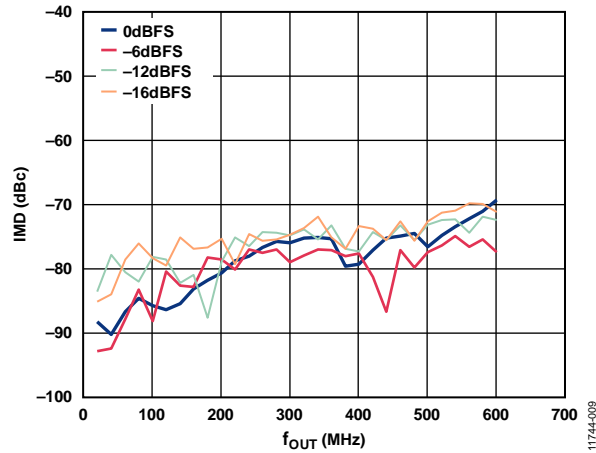

Figure 8. Two-Tone Third IMD vs. f_{OUT} over Digital Back Off, $f_{DAC} = 1228.8$ MHz

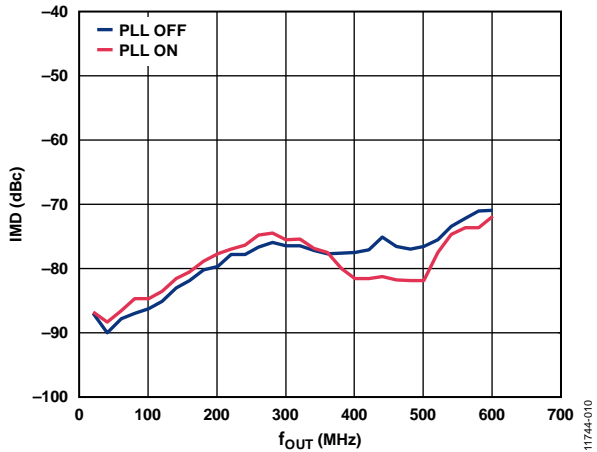

Figure 9. Two-Tone Third IMD vs. f_{OUT} over PLL on and off, $f_{DAC} = 1228.8$ MHz

11744-010

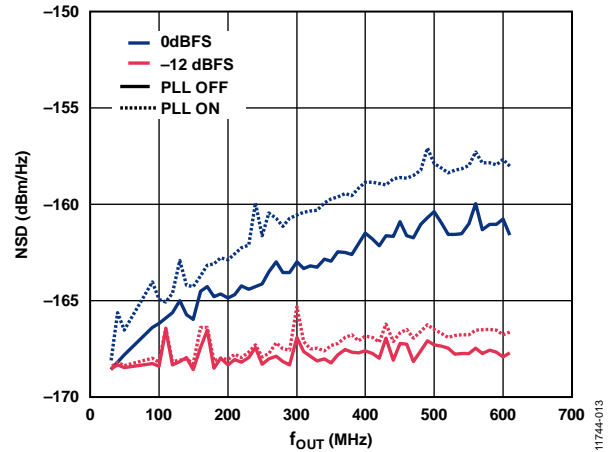

Figure 12. Single-Tone NSD vs. f_{OUT} , over Digital Back Off, PLL on and off

11744-013

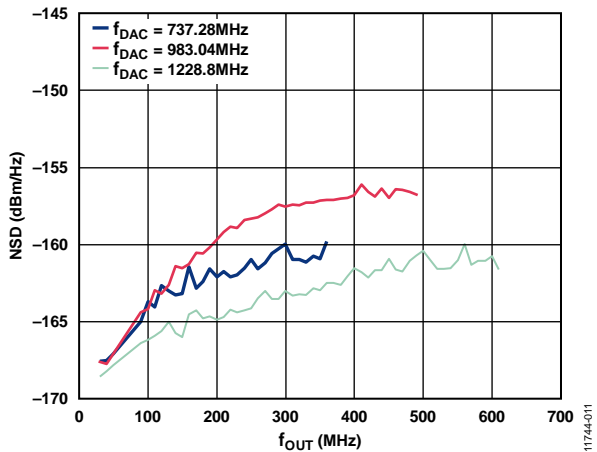

Figure 10. Single-Tone (0 dBFS) NSD vs. f_{OUT} over f_{DAC}

11744-011

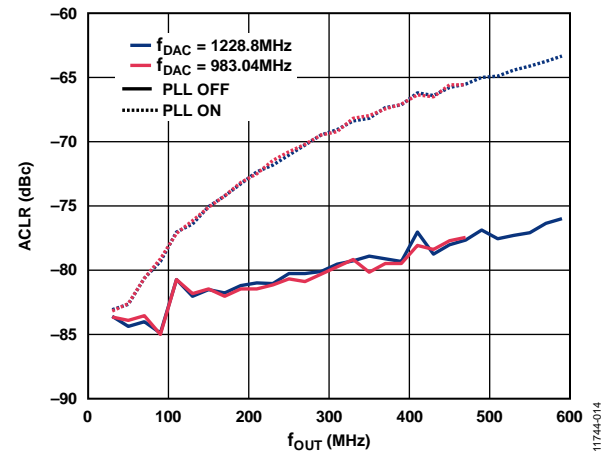

Figure 13. 1-Carrier WCDMA 1st Adjacent ACLR vs. f_{OUT} over f_{DAC} PLL on and off

11744-014

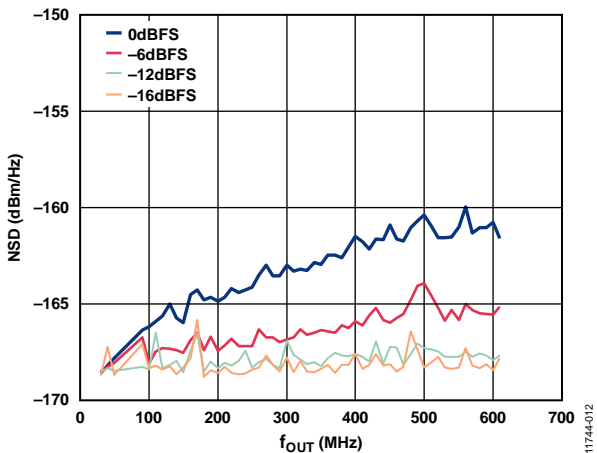

Figure 11. Single-Tone NSD vs. f_{OUT} , over Digital Back Off, $f_{DAC} = 1228.8$ MHz

11744-012

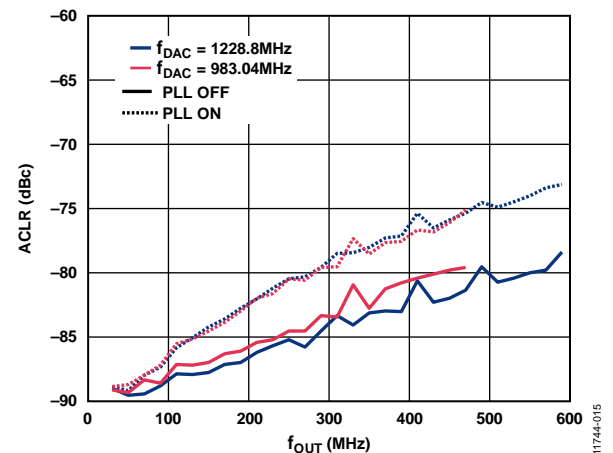

Figure 14. 1-Carrier WCDMA 2nd Adjacent ACLR vs. f_{OUT} over f_{DAC} PLL on and off

11744-015

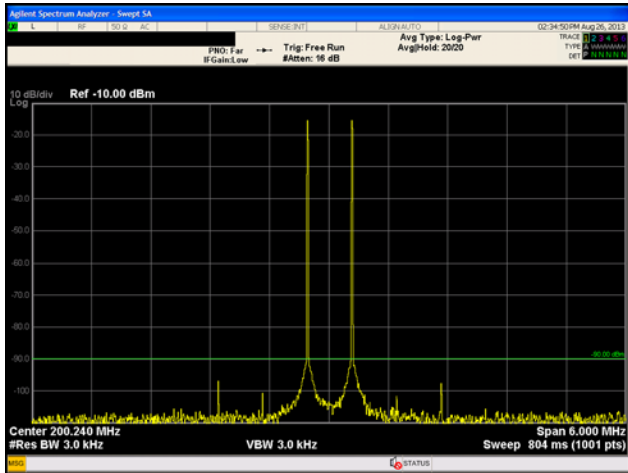

Figure 15. Two-Tone Third IMD Performance, $f_{IF} = 200$ MHz, $f_{DAC} = 1228.8$ MHz, -9 dBFS

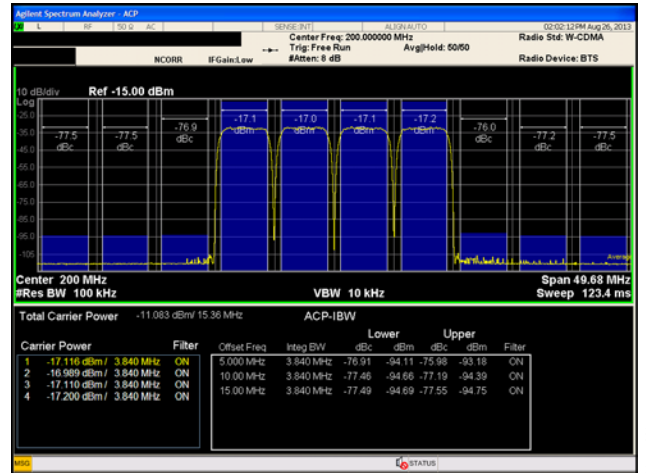

Figure 18. 4-Carrier WCDMA ACLR Performance, $f_{IF} = 200$ MHz, $f_{DAC} = 1228.8$ MHz

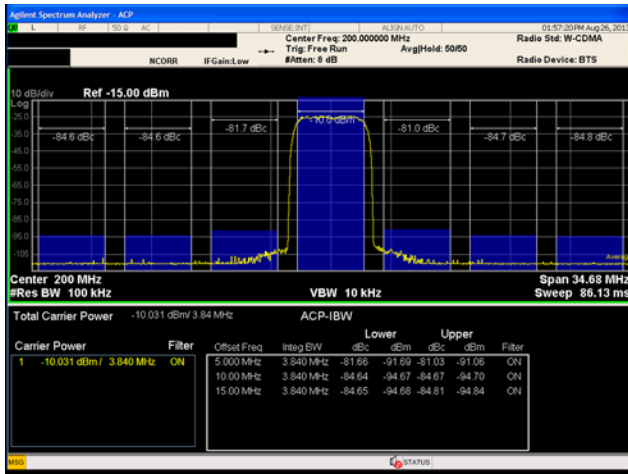

Figure 16. 1-Carrier WCDMA ACLR Performance, $f_{IF} = 200$ MHz, $f_{DAC} = 1228.8$ MHz

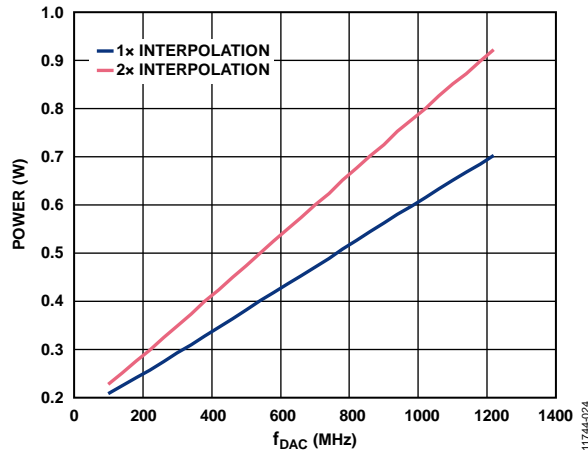

Figure 19. Total Power Consumption vs. f_{DAC} over Interpolation

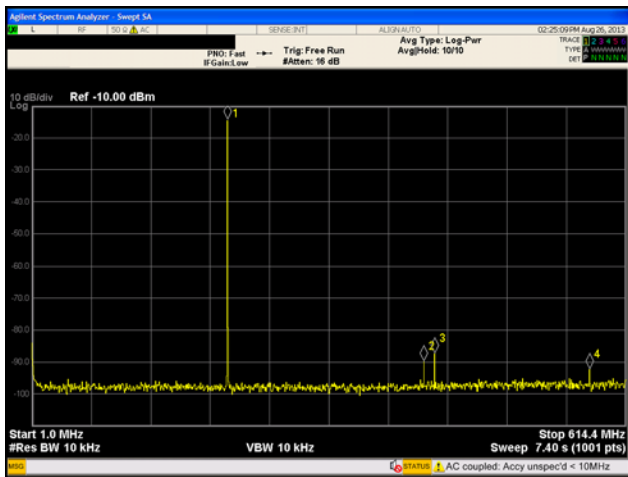

Figure 17. Single-Tone Performance, $f_{IF} = 200$ MHz, $f_{DAC} = 1228.8$ MHz

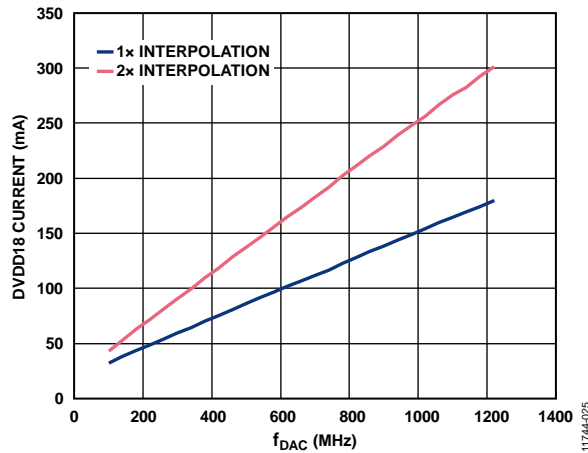

Figure 20. DVDD18 Current vs. f_{DAC} over Interpolation

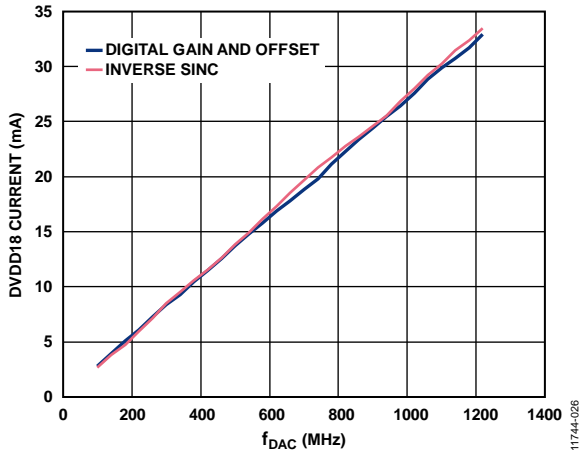

Figure 21. DVDD18 Current vs. f_{DAC} over Digital Functions

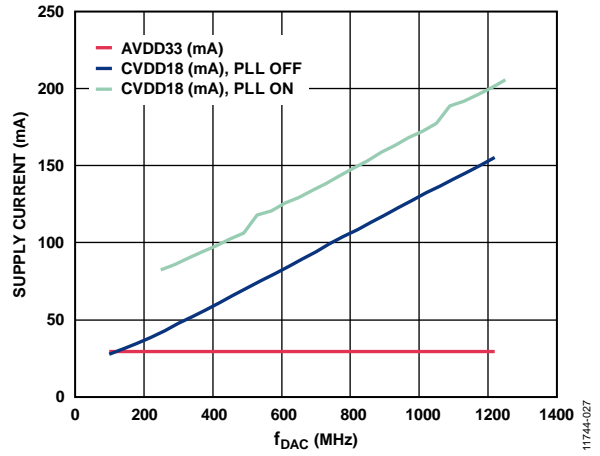

Figure 22. CVDD18 and AVDD18 Current vs. f_{DAC}

TERMINOLOGY

Integral Nonlinearity (INL)

INL is the maximum deviation of the actual analog output from the ideal output, determined by a straight line drawn from zero scale to full scale.

Differential Nonlinearity (DNL)

DNL is the measure of the variation in analog value, normalized to full scale, associated with a 1 LSB change in digital input code.

Offset Error

Offset error is the deviation of the output current from the ideal of 0 mA. For DACOUTP, 0 mA output is expected when all inputs are set to 0. For DACOUTN, 0 mA output is expected when all inputs are set to 1.

Gain Error

Gain error is the difference between the actual and ideal output span. The actual span is determined by the difference between the output when all inputs are set to 1 and the output when all inputs are set to 0.

Output Compliance Range

The output compliance range is the range of allowable voltage at the output of a current output DAC. Operation beyond the maximum compliance limits can cause either output stage saturation or breakdown, resulting in nonlinear performance.

Temperature Drift

Temperature drift is specified as the maximum change from the ambient (25°C) value to the value at either T_{MIN} or T_{MAX} . For offset and gain drift, the drift is reported in ppm of full-scale range (FSR) per degree Celsius. For reference drift, the drift is reported in ppm per degree Celsius.

Power Supply Rejection (PSR)

PSR is the maximum change in the full-scale output as the supplies are varied from minimum to maximum specified voltages.

Settling Time

Settling time is the time required for the output to reach and remain within a specified error band around its final value, measured from the start of the output transition.

Spurious Free Dynamic Range (SFDR)

SFDR is the difference, in decibels, between the peak amplitude of the output signal and the peak spurious signal within the dc to Nyquist frequency of the DAC. Typically, the interpolation filters reject energy in this band. This specification, therefore, defines how well the interpolation filters work and the effect of other parasitic coupling paths on the DAC output.

Signal-to-Noise Ratio (SNR)

SNR is the ratio of the rms value of the measured output signal to the rms sum of all other spectral components below the Nyquist frequency, excluding the first six harmonics and dc. The value for SNR is expressed in decibels.

Interpolation Filter

If the digital inputs to the DAC are sampled at a multiple rate of f_{DATA} (interpolation rate), a digital filter can be constructed that has a sharp transition band near $f_{DATA}/2$. Images that typically appear around f_{DAC} (output data rate) can be greatly suppressed.

Adjacent Channel Leakage Ratio (ACLR)

ACLR is the ratio in decibels relative to the carrier (dBc) between the measured power within a channel relative to its adjacent channel.

Complex Image Rejection

In a traditional two-part upconversion, two images are created around the second IF frequency. These images have the effect of wasting transmitter power and system bandwidth. By placing the real part of a second complex modulator in series with the first complex modulator, either the upper or lower frequency image near the second IF can be rejected.

SERIAL PORT OPERATION

The serial port is a flexible, synchronous serial communications port that allows easy interfacing to many industry standard micro-controllers and microprocessors. The serial I/O is compatible with most synchronous transfer formats, including both the Motorola SPI and Intel® SSR protocols. The interface allows read/write access to all registers that configure the AD9139. MSB first or LSB first transfer formats are supported. The serial port interface is a 3-wire only interface. The input and output share a single input/output (SDIO) pin.

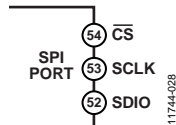

Figure 23. Serial Port Interface Pins

There are two phases to a communication cycle with the AD9139. Phase 1 is the instruction cycle (the writing of an instruction byte into the device), coincident with the first 16 SCLK rising edges. The instruction word provides the serial port controller with information regarding the data transfer cycle, Phase 2, of the communication cycle. The Phase 1 instruction word defines whether the upcoming data transfer is a read or write, together with the starting register address for the following data transfer.

A logic high on the \overline{CS} pin, followed by a logic low, resets the serial port timing to the initial state of the instruction cycle. From this state, the next 16 rising SCLK edges represent the instruction bits of the current I/O operation.

The remaining SCLK edges are for Phase 2 of the communication cycle. Phase 2 is the actual data transfer between the device and the system controller. Phase 2 of the communication cycle is a transfer of one data byte. Registers change immediately upon writing to the last bit of each transfer byte.

DATA FORMAT

The instruction byte contains the information shown in Table 9.

Table 9. Serial Port Instruction Word

I15 (MSB)	I[14:0]
R/ \overline{W}	A[14:0]

R/ \overline{W} (Bit 15 of the instruction word) determines whether a read or a write data transfer occurs after the instruction word write. Logic 1 indicates a read operation, and Logic 0 indicates a write operation.

A14 to A0 (Bit 14 to Bit 0 of the instruction word) determine the register that is accessed during the data transfer portion of the communication cycle. For multibyte transfers, A14 is the starting address; the device generates the remaining register addresses based on the SPI_LSB_FIRST bit.

SERIAL PORT PIN DESCRIPTIONS

Serial Clock (SCLK)

The serial clock pin, SCLK, synchronizes data to and from the device and runs the internal state machines. The maximum frequency of SCLK is 40 MHz. All data input is read on the rising edge of SCLK. All data is driven out on the falling edge of SCLK.

Chip Select (\overline{CS})

\overline{CS} is an active low input that starts and gates a communication cycle. It allows the use of multiple devices on the same serial communications line. The SDIO pin enters a high impedance state when the \overline{CS} input is high. During the communication cycle, \overline{CS} remains low.

Serial Data I/O (SDIO)

The SDIO pin is a bidirectional data line.

SERIAL PORT OPTIONS

The serial port supports both MSB first and LSB first data formats; the SPI_LSB_FIRST bit (Register 0x00, Bit 6) controls this functionality. The default is MSB first (SPI_LSB_FIRST = 0).

When SPI_LSB_FIRST = 0 (MSB first), the instruction and data bits must be written from MSB to LSB. Multibyte data transfers in MSB first format start with an instruction word that includes the register address of the most significant data byte. Subsequent data bytes must follow from high address to low address. In MSB first mode, the serial port internal word address generator decrements for each data byte of the multibyte communication cycle.

When SPI_LSB_FIRST = 1 (LSB first), the instruction and data bits must be written from LSB to MSB. Multibyte data transfers in LSB first format start with an instruction word that includes the register address of the least significant data byte. Subsequent data bytes must follow from low address to high address. In LSB first mode, the serial port internal word address generator increments for each data byte of the multibyte communication cycle.

When the MSB first mode is active, the serial port controller data address decrements from the data address written toward 0x00 for multibyte I/O operations. If the LSB first mode is active, the serial port controller data address increments from the data address written toward 0xFF for multibyte I/O operations.

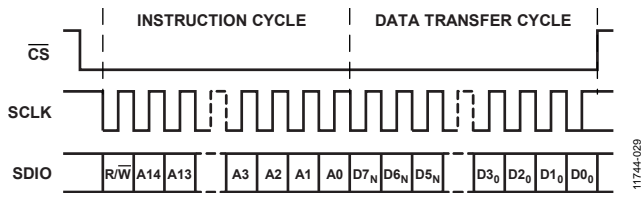

Figure 24. Serial Register Interface Timing, MSB First

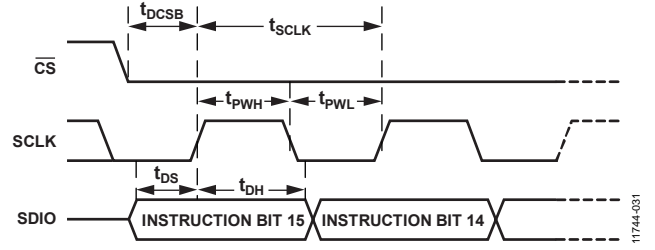

Figure 26. Timing Diagram for Serial Port Register Write

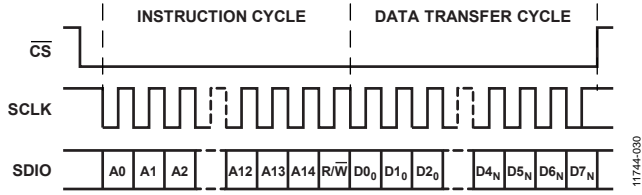

Figure 25. Serial Register Interface Timing, LSB First

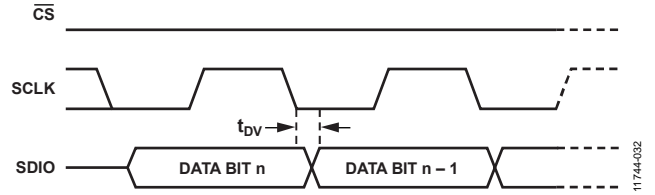

Figure 27. Timing Diagram for Serial Port Register Read

DATA INTERFACE

LVDS INPUT DATA PORTS

The AD9139 has a 16-bit LVDS bus that accepts 16-bit data either in word wide (16-bit) or byte wide (8-bit) formats. In the word wide interface mode, the data is sent over the entire 16-bit data bus. In the byte wide interface mode, the data is sent over the lower 8-bit (D7 to D0) LVDS bus. Table 10 lists the pin assignment of the bus and the SPI register configuration for each mode.

Table 10. LVDS Input Data Modes

Interface Mode	Input Data Width	SPI Register Configuration
Word	D15 to D0	Register 0x26, Bit 0 = 0
Byte	D7 to D0	Register 0x26, Bit 0 = 1

WORD INTERFACE MODE

In word mode, the digital clock input (DCI) signal is a reference bit that generates a double data rate (DDR) data sampling clock. Time align the DCI signal with the data.

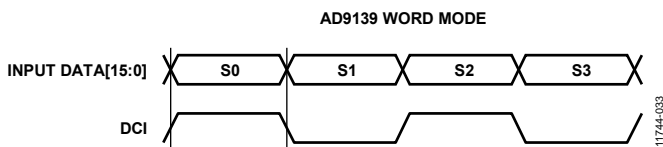

Figure 28. AD9139 Timing Diagram for Word Mode

BYTE INTERFACE MODE

In byte mode, the required sequence of the input data stream is S0[15:8], S0[7:0], S1[15:8], S1[7:0], and so forth. A frame signal is required to align the order of input data bytes properly. Time align both the DCI signal and frame signal with the data. The rising edge of the frame indicates the start of the sequence. The frame can be either a one shot or periodical signal as long as its first rising edge is correctly captured by the device. For a one shot frame, the frame pulse must be held at high for at least one DCI cycle. For a periodical frame, the frequency must be

$$f_{DCI}(2 \times n)$$

where n is a positive integer, that is, 1, 2, 3, ...

Figure 29 is an example of signal timing in byte mode.

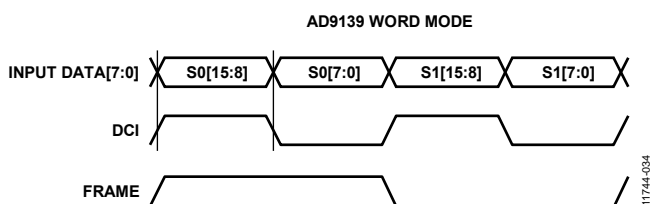

Figure 29. Timing Diagram for Byte Mode

DATA INTERFACE CONFIGURATION OPTIONS

To provide more flexibility for the data interface, additional options are listed in Table 11.

Table 11. Data Interface Configuration Options

Register 0x26, Bit 7	Description
DATA_FORMAT	Select between binary and twos complement formats.

DLL INTERFACE MODE

A source synchronous LVDS interface is used between the data host and the AD9139 to achieve high data rates while simplifying the interface. The FPGA or ASIC feeds the AD9139 with 16-bit input data. Together with the input data, the FPGA or ASIC provides a DDR DCI.

A delay locked loop (DLL) circuit, designed to operate with DCI clock rates between 250 MHz and 575 MHz, generates a phase shifted version of the DCI signal, called a data sampling clock (DSC), to register the input data on both the rising and falling edges.

As shown in Figure 31, the DCI clock edges must be coincident with the data bit transitions with minimum skew and jitter. The nominal sampling point of the input data occurs in the middle of the DCI clock edges because this point corresponds to the center of the data eye. This is also equivalent to a nominal phase shift of 90° of the DCI clock.

The data timing requirements are defined by a data valid window (DVW) that is dependent on the data clock input skew, input data jitter, and the variations of the DLL delay line across delay settings. The DVW is defined as

$$DVW = t_{DATA PERIOD} - t_{DATA SKEW} - t_{DATA JITTER}$$

The available margin for data interface timing is given by

$$t_{MARGIN} = DVW - (t_S + t_H)$$

The difference of the setup and hold times, which is also called the keep out window, or KOW, is the area where data transitions are prohibited. The timing margin allows the user to set the DLL delay, as shown in Figure 30.

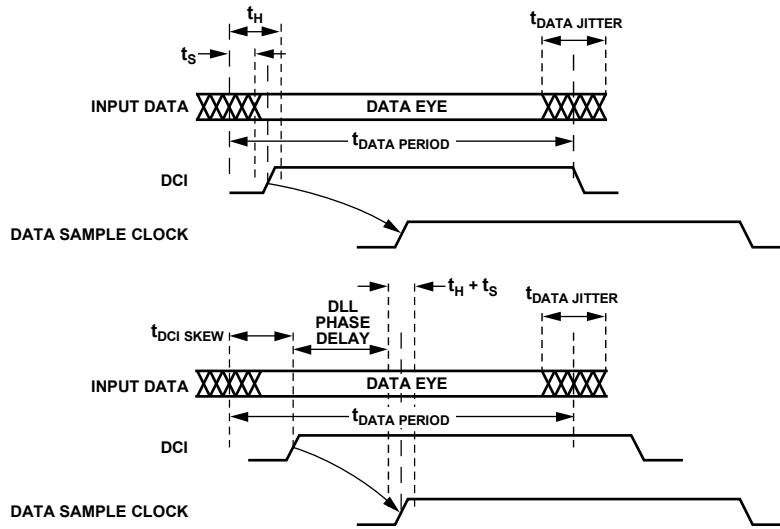

Figure 30. LVDS Data Port Timing Requirements

Figure 30 shows that the ideal location for the DSC signal is 90° out of phase from the DCI input; however, due to skew of the DCI relative to the data, it may be necessary to change the DSC phase offset to sample the data at the center of its eye diagram. Vary the sampling instance in discrete increments by offsetting the nominal DLL phase shift value of 90° via Register 0x0A, Bits[3:0]. This register is a signed value. The MSB is the sign and the LSBs are the magnitude. The following equation defines the phase offset relationship:

$$\text{Phase Offset} = 90^\circ + n \times 11.25^\circ, |n| < 7$$

where n is the DLL phase offset setting.

Figure 31 shows the DSC setup and hold times with respect to the DCI signal and data signals.

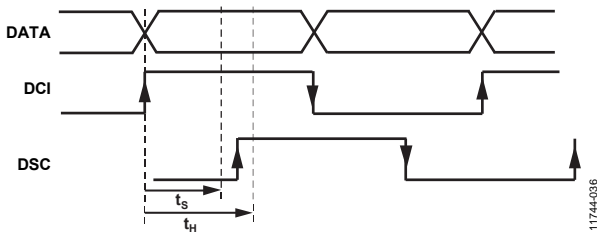

Figure 31. LVDS Data Port Setup and Hold Times

Table 12 lists the guaranteed values across the operating conditions. These values were obtained using a 50% duty cycle and a DCI swing of 450 mV p-p. For best performance, maintain a duty cycle variation below ±5% and set the DCI input as high as possible, up to 1200 mV p-p.

Table 12. DLL Phase Setup and Hold Times (Guaranteed)

Frequency, f_{DCI} (MHz)	Time (ps)	Data Port Setup and Hold Times (ps) at DLL Phase		
		-3	0	+3
307	t_S	-125	-385	-695
	t_H	834	1120	1417
368	t_S	-70	-305	-534
	t_H	753	967	1207
491	t_S	-81	-245	-402
	t_H	601	762	928
614	t_S	-54.0	-167	-277
	t_H	497	603	721

Table 13. DLL Phase Setup and Hold Times (Typical)

Frequency, f _{DCI} ¹ (MHz)	Time (ps)	Data Port Setup and Hold Times (ps) at DLL Phase												
		-6	-5	-4	-3	-2	-1	0	+1	+2	+3	+4	+5	+6
250	t _s	-93	-196	-312	-416	-530	-658	-770	-878	-983	-1093	-1193	-1289	-1412
	t _H	468	579	707	825	947	1067	1188	1315	1442	1570	1697	1777	1876
275	t _s	-87	-172	-264	-364	-464	-556	-653	-756	-859	-956	-1053	-1151	-1251
	t _H	451	537	646	757	878	977	1092	1218	1311	1423	1537	1653	1728
300	t _s	-82	-166	-256	-341	-426	-515	-622	-715	-809	-900	-1001	-1097	-1184
	t _H	422	500	598	703	803	897	1000	1105	1203	1303	1411	1522	1612
325	t _s	-46	-114	-190	-271	-358	-447	-538	-612	-706	-806	-891	-966	-1044
	t _H	405	483	563	647	740	832	914	1000	1100	1200	1292	1380	1476
350	t _s	-23	-92	-180	-252	-328	-409	-491	-574	-654	-731	-819	-889	-959
	t _H	383	451	524	607	682	762	844	930	1011	1097	1186	1277	1358
375	t _s	-7	-82	-150	-225	-315	-391	-461	-526	-595	-661	-726	-786	-853
	t _H	401	466	504	569	641	718	783	863	941	1025	1106	1187	1264
400	t _s	-46	-98	-161	-243	-303	-384	-448	-513	-578	-643	-713	-771	-833
	t _H	385	445	503	546	604	674	748	826	890	965	1039	1110	1178
425	t _s	4	-52	-110	-170	-229	-297	-394	-449	-517	-579	-641	-704	-752
	t _H	358	408	465	524	595	625	692	762	829	900	966	1032	1097
450	t _s	11	-34	-92	-147	-209	-269	-324	-386	-446	-509	-564	-622	-672
	t _H	354	406	457	516	573	637	693	731	792	852	917	983	1042
475	t _s	-15	-51	-95	-147	-198	-255	-313	-366	-425	-480	-530	-585	-640
	t _H	355	399	451	499	556	613	675	727	779	815	873	930	988
500	t _s	9	-28	-77	-128	-183	-233	-288	-333	-390	-438	-495	-545	-594
	t _H	313	354	399	445	500	555	615	668	726	783	825	881	934
525	t _s	-7	-52	-100	-147	-187	-237	-285	-335	-387	-436	-483	-530	-581
	t _H	311	356	395	438	489	537	592	645	692	746	799	850	909
550	t _s	-5	-39	-74	-107	-147	-192	-249	-302	-352	-397	-440	-486	-529
	t _H	300	340	378	423	468	510	560	610	659	710	756	810	865
575	t _s	8	-28	-66	-102	-143	-181	-245	-280	-336	-366	-406	-443	-488
	t _H	312	348	379	414	453	496	544	599	654	708	759	806	847

¹ Table 13 shows characterization data for selected f_{DCI} frequencies. Other frequencies are possible; use Table 13 to estimate performance.

Table 13 shows the typical times for various DCI clock frequencies that are required to calculate the data valid margin. Use Table 13 to determine the amount of margin that is available for tuning of the DSC sampling point.

Maximizing the opening of the eye in both the DCI and data signals improves the reliability of the data port interface. Use differential controlled impedance traces of equal length (that is, delay) between the host processor and the AD9139 input. To ensure coincident transitions with the data bits, implement the DCI signal as an additional data line with an alternating (010101...) bit sequence from the same output drivers that are used for the data.

The DCI signal is ac-coupled by default; thus, removing the DCI signal may cause DAC output chatter due to randomness on the DCI input. To avoid this, disable the DAC output whenever the DCI signal is not present by setting the DAC output current power-down bit in Register 0x01[7] to 1. When the DCI signal is again present, enable the DAC output by programming Register 0x01[7] to 0.

Register 0x0D optimizes the DLL stability over the operating frequency range. Table 14 shows the recommended settings.

Table 14. DLL Configuration Options

DCI Speed	Register 0x0D
≥350 MHz	0x06
<350 MHz	0x86

Poll the status of the DLL by reading the data status register at Address 0x0E. Bit 0 indicates that the DLL is running and attempting lock; Bit 7 is 1 when the DLL has locked. Bit 2 is 1 when a valid data clock input (DCI) is detected. The warning bits in [6:4] in Register 0x0E can be used as indicators that the DAC may be operating in a nonideal location in the delay line. Note that these bits are read at the SPI port speed, which is much slower than the actual speed of the DLL. This means they can only show a snapshot of what is happening as opposed to giving real-time feedback.

DLL Configuration Example 1

In the following DLL configuration example, $f_{DCI} = 600$ MHz, DLL is enabled, and DLL phase offset = 0.

1. `0x5E → 0xFE /* Turn off LSB delay cell*/`
2. `0x0D → 0x06 /* Select DLL configure options */`
3. `0x0A → 0xC0 /* Enable DLL and duty cycle correction. Set DLL phase offset to 0 */`
4. `Read 0x0E[7:4] /* Expect 1000b if the DLL is locked */`

DLL Configuration Example 2

In the following DLL configuration example, $f_{DCI} = 300$ MHz, DLL is enable, and DLL phase offset = 0.

1. `0x5E → 0xFE /* Turn off LSB delay cell*/`
2. `0x0D → 0x86 /* Select DLL configure options */`
3. `0x0A → 0xC0 /* Enable DLL and duty cycle correction. Set DLL phase offset to 0 */`
4. `Read 0x0E[7:4] /* Expect 1000b if the DLL is locked */`

PARITY

The data interface can be continuously monitored by enabling the parity bit feature in Register 0x6A[7] and configuring the frame/parity bit as parity by setting Register 0x09 = 0x21. In this case, the host sends a parity bit with each data sample. This bit is set according to the following formulas, where n is the data sample that is being checked:

For even parity,

$$XOR[FRM(n), D0(n), D1(n), D2(n), \dots, D15(n)] = 0$$

For odd parity,

$$XOR[FRM(n), D0(n), D1(n), D2(n), \dots, D15(n)] = 1$$

The parity bit is calculated over 17 bits (including the frame/parity bit).

If a parity error occurs, the parity error counter (Register 0x6B or Register 0x6C) increments. Parity errors on the bits sampled by the rising edge of the DCI signal increment the rising edge parity counter (Register 0x6B) and set the PARERRRIS bit (Register 0x6A[0]). Parity errors on the bits sampled by the falling edge of DCI increment the falling edge parity counter (Register 0x6C) and set the PARERRFAL bit (Register 0x6A[1]). The parity counter continues to accumulate until it clears or until it reaches a maximum value of 255. To clear the count, write a 1 to Register 0x6A[5].

To trigger an IRQ when a parity error occurs, write 1 to Bit 7 in Register 0x04. This IRQ triggers when there is either a rising edge or falling edge parity error. Observe the status of the IRQ pin via Register 0x06[7] or by using the selected IRQx pin. Clear the IRQ by writing a 1 to Register 0x06[7].

Use the parity bit feature to validate the interface timing. As described previously, the host provides a parity bit with the data

samples, as well as configures the AD9139 to generate an IRQ. The user can then sweep the sampling instance of the input registers of the AD9139 to determine at what point sampling errors occur. The sampling instance can be varied in discrete increments by offsetting the nominal DLL phase shift value of 90° via SPI Register 0x0A[3:0].

SED OPERATION

The AD9139 provides on-chip sample error detection (SED) circuitry that simplifies verification of the input data interface. The SED compares the input data samples captured at the digital input pins with a set of comparison values. The comparison values are loaded into registers through the SPI port. Differences between the captured values and the comparison values are detected. Options are available for customizing SED test sequencing and error handling.

The SED circuitry allows the application to test a short user defined pattern to confirm that the high speed source synchronous data bus is correctly implemented and meets the timing requirement. Unlike the parity bit, the SED circuitry is expected to be used during initial system calibration, before the AD9139 is in use in the application. The SED circuitry operates on a data set made up of user defined input words, denoted as S0, S1, S2, and S3. The user defined pattern consists of sequential data-word samples (S0 is sampled on the rising edge of DCI, S1 is sampled on the following falling edge of DCI, S2 is sampled on the following DCI rising edge, and S3 is sampled on the following DCI falling edge). The user loads this data pattern in the byte format into Register 0x61 through Register 0x68.

The depth of the user defined pattern is selectable via Bit 4 of the SED_CTRL register (0x60). A default of 0, means a depth of two (using S0 and S1), and a 1 means a depth of four (using S0, S1, S2, and S3, and requiring the use of frame signal input to define S0 to the SED state machine). To properly align the input samples using a depth of 4, S0 is indicated by asserting the frame signal for a minimum of two complete input samples as shown in. The frame signal can be issued once at the start of the data transmission, or it can be asserted repeatedly at intervals coinciding with the S0 word.

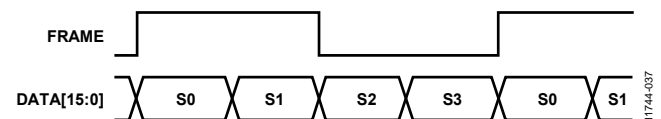

Figure 32. Timing Diagram of Extended FRAMEx Signal Required to Align Input Data for SED

The SED has three flag bits (Register 0x60, Bit 0, Bit 1, and Bit 2) that indicate the results of the input sample comparisons. The sample error detected bit (Register 0x60, Bit 0) is set when an error is detected and remains set until cleared.

The autosample error detection (AED) mode is an autoclear mode that has two effects: it activates the compare fail bit and the compare pass bit (Register 0x60, Bit 1 and Bit 2). The compare pass bit sets if the last comparison indicated the sample was error free. The compare fail bit sets if an error is

detected. The compare fail bit is automatically cleared by the reception of eight consecutive error free comparisons when autoclear mode is enabled.

The sample error flag can be configured to trigger an $\overline{\text{IRQ}}$ when active, if desired, by enabling the appropriate bit in the event flag register (Register 0x04, Bit 6).

SED EXAMPLE

Normal Operation

The following example illustrates the AD9139 SED configuration for continuously monitoring the input data and assertion of an $\overline{\text{IRQ}}$ when a single error is detected.

1. Write to the following registers to enable the SED and load the comparison values with a four-deep user pattern. Comparison values can be chosen arbitrarily; however, choosing values that require frequent bit toggling provides the most robust test.
 - a. Register 0x61[7:0] → S0[7:0]
 - b. Register 0x62[7:0] → S0[15:8]
 - c. Register 0x63[7:0] → S1[7:0]
 - d. Register 0x64[7:0] → S1[15:8]
 - e. Register 0x65[7:0] → S2[7:0]
 - f. Register 0x66[7:0] → S2[15:8]
 - g. Register 0x67[7:0] → S3[7:0]
 - h. Register 0x68[7:0] → S3[15:8]
2. Enable SED.
 - a. Register 0x60 → 0xD0
 - b. Register 0x60 → 0x90
3. Enable the SED error detect flag to assert the $\overline{\text{IRQx}}$ pin.
 - a. Register 0x04[6] = 1
4. Begin transmitting the input data pattern (FRAME_x is also required because the depth of the pattern is 4).

DELAY LINE INTERFACE MODE

The DLL is designed to help ease the interface timing requirements in very high speed data rate applications. The DLL has a minimum supported interface speed of 250 MHz, as shown in Table 2. For interface rates below this speed, use the interface delay line. In this mode, the DLL is powered off and a four-tap delay line is provided for the user to adjust the timing between the data bus and the DCI. Table 15 specifies the setup and hold times for each delay tap.

Table 15. Delay Line Setup and Hold Times (Guaranteed)

Delay Setting	0	1	2	3
Register 0x5E[7:0]	0x00	0x80	0xF0	0xFE
Register 0x5F[2:0]	0x60	0x67	0x67	0x67
t_s (ns) ¹	-0.81	-0.97	-1.13	-1.28
t_H (ns)	1.96	2.20	2.53	2.79
$ t_s + t_H $ (ns)	1.15	1.23	1.40	1.51

¹ The negative sign indicates the direction of the setup time. The setup time is defined as positive when it is on the left side of the clock edge and negative when it is on the right side of the clock edge.

There is a fixed 1.38 ns delay on the DCI signal when the delay line is enabled. Each tap adds a nominal delay of 200 ps to the fixed delay. To achieve the best timing margin, that is, to center the setup and hold window in the middle of the data eye, the user may need to add a delay on the data bus with respect to the DCI signal in the data source. Figure 33 is an example of calculating the optimal external delay.

Register 0x0D[4] configures the DCI signal coupling settings for optimal interface performance over the operating frequency range. It is recommended that this bit be set to 1 (dc-coupled DCI) in the delay line interface mode.

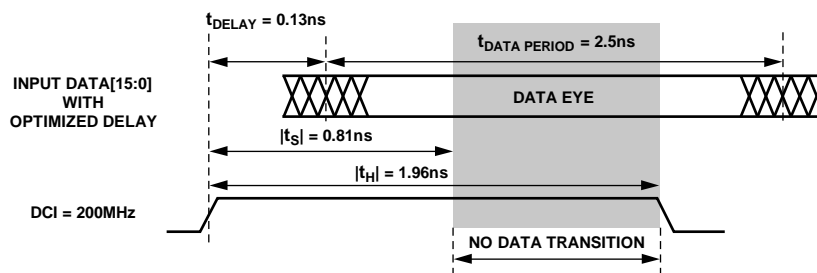

Figure 33. Example of Interfacing Timing in the Delay Line-Based Mode

11744-03B

Interface Timing Requirements

The following example shows how to calculate the optimal delay at the data source to achieve the best sampling timing in the delay line interface mode:

- $f_{DCI} = 200$ MHz
- Delay setting = 0

The shadow area in Figure 33 is the interface setup and hold time window set to 0. To optimize the interface timing, this window must be placed in the middle of the data transitions. Because the input is double data rate, the available data period is 2.5 ns. Therefore, the optimal data bus delay, with respect to the DCI signal at the data source, can be calculated as

$$t_{DELAY} = \frac{(|t_S| + |t_H|)}{2} - \frac{t_{DATA PERIOD}}{2} = 1.38 - 1.25 = 0.13 \text{ ns}$$

SPI Sequence to Enable Delay Line-Based Mode

Use the following SPI sequence to enable the delay line-based mode:

1. 0x5E → 0x00 /* Configure the delay setting */
2. 0x5F → 0x60
3. 0x0D → 0x16 /* DC couple DCI */
4. 0x0A → 0x00 /* Turn off DLL and duty cycle correction */

FIFO OPERATION

The AD9139 adopts source synchronous clocking in the data receiver (see the Data Interface section). The nature of source synchronous clocking is the creation of a separate clock domain at the receiving device. In the DAC, it is the DAC clock domain, that is, the DACCLK. Therefore, there are two clock domains inside of the DAC: the DCI and the DACCLK. Often, these two clock domains are not synchronous, requiring an additional stage to adjust the timing for proper data transfer. In the AD9139, a FIFO stage is inserted between the DCI and DACCLK domains to transfer the received data into the core clock domain (DACCLK) of the DAC.

The AD9139 contains a 2-channel, 16-bit wide, eight-word deep FIFO. The FIFO acts as a buffer that absorbs timing variations between the two clock domains. The timing budget between the two clock domains in the system is significantly relaxed due to the depth of the FIFO.

Figure 34 shows the block diagram of the datapath through the FIFO. The input data is latched into the device, formatted, and then written into the FIFO register, which is determined by the FIFO write pointer. The value of the write pointer is incremented every time a new word is loaded into the FIFO. Meanwhile, data

is read from the FIFO register, which is determined by the read pointer, and fed into the digital datapath. The value of the read pointer is incremented every time data is read into the datapath from the FIFO. The FIFO pointers are incremented at the data rate, which is the DACCLK rate divided by the interpolation rate.

Valid data is transmitted through the FIFO as long as the FIFO does not overflow (full) or underflow (empty). An overflow or underflow condition occurs when the write pointer and read pointer point to the same FIFO slot. This simultaneous access of data leads to unreliable data transfer through the FIFO and must be avoided.

Normally, data is written to and read from the FIFO at the same rate to maintain a constant FIFO depth. If data is written to the FIFO faster than data is read, the FIFO depth increases. If data is read from the FIFO faster than data is written to it, the FIFO depth decreases. For optimal timing margin, maintain the FIFO depth near half full (a difference of four between the write pointer and read pointer values). The FIFO depth represents the FIFO pipeline delay and is part of the overall latency of the AD9139.

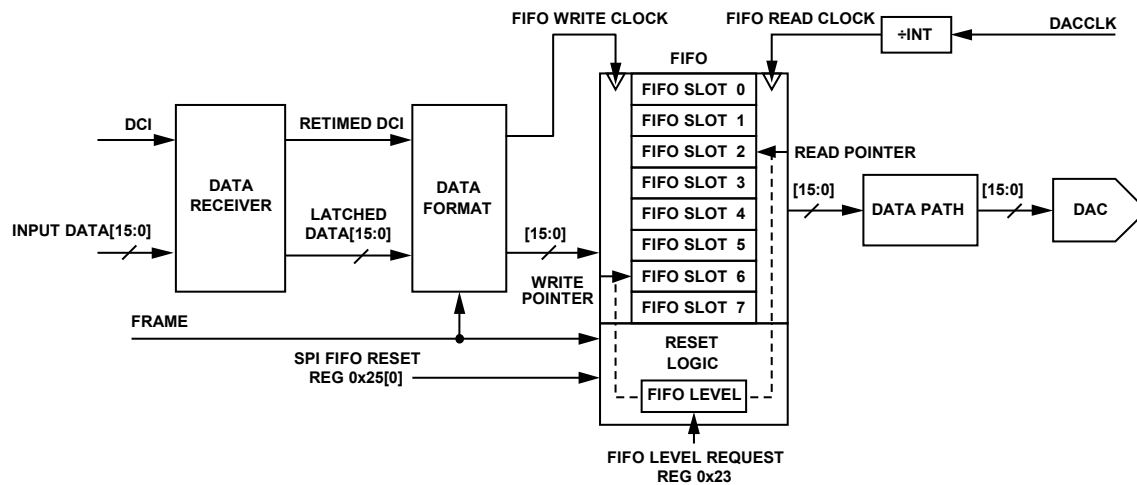

Figure 34. Block Diagram of FIFO

11744-089

RESETTING THE FIFO

Upon device power-on, the read and write pointers start to roll around the FIFO from an arbitrary slot; consequently, the FIFO depth is unknown. To avoid a concurrent read and write to the same FIFO address and to assure a fixed pipeline delay from power-on to power-on, it is important to reset the FIFO pointers to a known state each time the device powers on or wakes up. This state is specified in the requested FIFO level (FIFO depth and FIFO level are used interchangeably in this data sheet), which consists of two parts: the integer FIFO level and the fractional FIFO level.

The integer FIFO level represents the difference of the states between the read and write points in the unit of input data period ($1/f_{DATA}$). The fractional FIFO level represents the difference of the FIFO pointers that is smaller than the input data period. The resolution of the fractional FIFO level is the input data period divided by the interpolation ratio and, thus, it is equal to one DACCLK cycle.

The exact FIFO level, that is, the FIFO latency, can be calculated by

$$FIFO\ Latency = Integer\ Level + Fractional\ Level$$

Because the FIFO has eight data slots, there are eight possible FIFO integer levels. The maximum supported interpolation rate in the [AD9139](#) is $2\times$ interpolation. Therefore, there are two possible FIFO fractional levels.

Two 3-bit registers in Register 0x23 are assigned to represent the two FIFO levels, as follows:

- Bits[6:4] represent the FIFO integer level
- Bits[2:0] represent the FIFO fractional level

For example, if the interpolation rate is $2\times$ and the desired total FIFO depth is 4.5 input data periods, set the FIFO_LEVEL_CONFIG (Register 0x23) to 0x41 (4 means four data cycles and 1 means one DAC cycle, which is half of a data cycle, in this case).

Reset the FIFO and initialize the FIFO level using either of the following methods:

- Serial port (SPI) initiated FIFO reset
- Frame initiated FIFO reset

SERIAL PORT INITIATED FIFO RESET

A SPI initiated FIFO reset is the most common method to reset the FIFO. To initialize the FIFO level through the serial port, toggle FIFO_SPI_RESET_REQUEST (Register 0x25, Bit 0) from 0 to 1 and back to 0. When the write to this register is complete, the FIFO level is initialized to the requested FIFO level and the readback of FIFO_SPI_RESET_ACK (Register 0x25, Bit 1) is set to 1. The FIFO level readback, in the same format as the FIFO level request, must be within ± 1 DACCLK cycle of the requested level. For example, if the requested value is 0x40 in $2\times$ interpolation, the readback value should be one of the following: 0x31, 0x40, or 0x41. The range of ± 1 DACCLK cycle indicates the default DAC latency uncertainty from power-on to power-on without turning on synchronization.

The recommended procedure for a serial port FIFO reset is as follows:

1. Configure the DAC in the desired interpolation mode (Register 0x28[7]).
2. Ensure that the DACCLK and DCI clocks are running and stable at the clock inputs.
3. Program Register 0x23 to 0x41.
4. Request the FIFO level reset by setting Register 0x25[0] to 1.
5. Verify that the device acknowledges the request by setting Register 0x25[1] to 1.
6. Remove the request by setting Register 0x25[0] to 0.
7. Verify that the device drops the acknowledge signal by setting Register 0x25[1] to 0.
8. Read back Register 0x06[2] and Register 0x06[1]. If both bits are 0, continue to Step 9. If any of the two bits is 1, program Register 0x23 to 0x40.
9. Read back Register 0x24 multiple times to verify that the actual FIFO level is set to the requested level (Register 0x23), and that the readback values are stable. By design, the readback is within ± 1 DACCLK around the requested level.

FRAME INITIATED FIFO RESET

The frame input has two functions. One function is to indicate the beginning of a byte stream in the byte interface mode, as described in the Data Interface section. The other function is to initialize the FIFO level by asserting the frame signal high for at least the time interval required to load two samples of data to the DAC. This corresponds to one DCI period in word mode and two DCI periods in byte mode. Note that this requirement of the frame pulse length is longer than that of the frame signal when it serves only to assemble the byte stream. The device accepts either a continuous frame or a one shot frame signal.

In the continuous reset mode, the FIFO responds to every valid frame pulse and resets itself. In the one shot reset mode, the FIFO responds only to the first valid frame pulse after the FRAME_RESET_MODE bits (Register 0x22[1:0]) are set. Therefore, even with a continuous frame input, the FIFO resets one time only; this prevents the FIFO from toggling between the two states from periodic resets. The one shot frame reset mode is the default and the recommended mode.

The recommended procedure for a frame initiated FIFO reset is as follows:

1. Configure the DAC in the desired interpolation mode (Register 0x28[7]).
2. Ensure that the DACCLK and DCI clocks are running and stable at the clock inputs.
3. Ensure that the DLL is locked (if using DLL Mode) or the DCI clock is being sent properly (if using bypass mode).
4. Program Register 0x23 to 0x41.
5. Configure the FRAME_RESET_MODE bits (Register 0x22[1:0]) to 10.
6. Choose one shot frame mode by writing 0 to EN_CON_FRAME_RESET (Register 0x22[2]).
7. Toggle the frame input from 0 to 1 and back to 0. The pulse width must be longer than the minimum requirement.
8. Read back Register 0x06[2] and Register 0x06[1]. If both bits are 0, continue to Step 9. If any of the two bits are 1, program Register 0x23 to 0x40.
9. Read back Register 0x24 multiple times to verify that the actual FIFO level is set to the requested level (Register 0x23) and the readback values are stable. By design, the readback should be within ± 1 DACCLK around the requested level.

These procedures apply in synchronization off mode only. For resetting FIFO in synchronization on mode, refer to the synchronization procedure in the Multidevice Synchronization and Fixed Latency section. FIFO reset is one of the steps to achieve synchronization.

Monitoring the FIFO Status

Monitor the real-time FIFO status from SPI Register 0x24, which reflects the real-time FIFO depth after a FIFO reset. Without timing drifts in the system, this readback does not change from that which resulted from the FIFO reset. When there is a timing drift or other abnormal clocking situation, the FIFO level readback can change. However, as long as the FIFO does not overflow or underflow, there is no error in data transmission. The status bits in Register 0x06, Bits[2:1] indicate if there are FIFO underflows or overflows. Latch the status of the two bits to trigger the hardware interrupts, IRQ1 and IRQ2. To enable latching and interrupts, configure the corresponding bits in Register 0x03 and Register 0x04.

DIGITAL DATAPATH

The block diagram in Figure 35 shows the functionality of the digital datapath. The digital processing includes

- One half-band interpolation filter
- An inverse sinc filter
- A gain and offset adjustment block

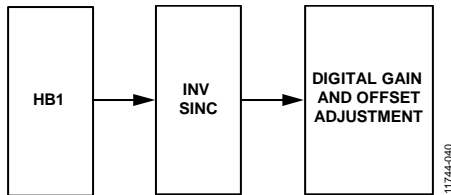

Figure 35. Block Diagram of Digital Datapath

INTERPOLATION FILTERS

The transmit path contains a half-band interpolation filter. The interpolation filter provides a 2× increase in output data rate and a low-pass function.

The AD9139 provides two interpolation modes. Each mode offers a different usable signal bandwidth in an operating mode. Which mode to select depends on the required signal bandwidth and the DAC update rate. Refer to Table 5 for the maximum speed and signal bandwidth of each interpolation mode.

The usable bandwidth in 1× interpolation is the DCI rate or half of the input data rate. The usable bandwidth in 2× interpolation is 0.8 times the DCI rate or 0.4 times the input data rate. It is defined as the frequency band over which the filters have a pass-band ripple of less than ±0.001 dB and a stop-band rejection of greater than 85 dB.

2× Interpolation Mode

Figure 36 and Figure 37 show the pass-band and all-band filter response for 2× mode. Note that the transition from the transition band to the stop band is much sharper than the transition from the pass band to the transition band. Therefore, when the desired output signal moves out of the defined pass band, the signal image, which is supposed to be suppressed by the stop band, grows faster than the droop of the signal itself due to the degraded pass-band flatness. In cases where the degraded image rejection is acceptable or can be compensated by the analog low-pass filter at the DAC output, it is possible to let the output signal extend beyond the specified usable signal bandwidth.

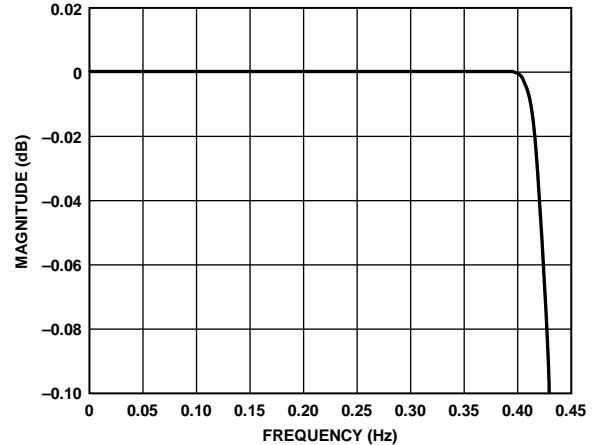

Figure 36. Pass-Band Detail of 2× Mode

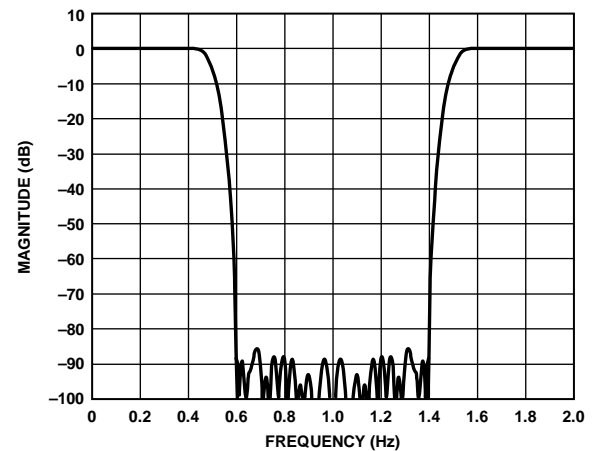

Figure 37. All-Band Response of 2× Mode

Table 16. Half-Band Filter 1 Coefficient

Lower Coefficient	Upper Coefficient	Integer Value
H(1)	H(55)	-4
H(2)	H(54)	0
H(3)	H(53)	+13
H(4)	H(52)	0
H(5)	H(51)	-32
H(6)	H(50)	0
H(7)	H(49)	+69
H(8)	H(48)	0
H(9)	H(47)	-134
H(10)	H(46)	0
H(11)	H(45)	+239
H(12)	H(44)	0
H(13)	H(43)	-401
H(14)	H(42)	0
H(15)	H(41)	+642
H(16)	H(40)	0
H(17)	H(39)	-994
H(18)	H(38)	0
H(19)	H(37)	+1512
H(20)	H(36)	0
H(21)	H(35)	-2307
H(22)	H(34)	0
H(23)	H(33)	+3665
H(24)	H(32)	0
H(25)	H(31)	-6638
H(26)	H(30)	0
H(27)	H(29)	+20,754
H(28)		+32,768

INVERSE SINC FILTER

The AD9139 provides a digital inverse sinc filter to compensate for the DAC rolloff over frequency. The inverse sinc (sinc^{-1}) filter is a seven-tap FIR filter. Figure 38 shows the frequency response of $\text{sin}(x)/x$ rolloff, the inverse sinc filter, and their composite response. The composite response has less than ± 0.05 dB pass-band ripple up to a frequency of $0.4 \times f_{\text{DAC}}$.

To provide the necessary peaking at the upper end of the pass band, the inverse sinc filter has an intrinsic insertion loss of approximately 3.8 dB. Offset the loss of the digital gain by increasing the digital gain adjustment setting to minimize the impact on the output signal-to-noise ratio (SNR). However, care is needed to ensure that the additional digital gain does not cause signal saturation, especially at high output frequencies. The sinc^{-1} filter is disabled by default; it can be enabled by setting the INVSINC_ENABLE bit to 1 in Register 0x27[7].

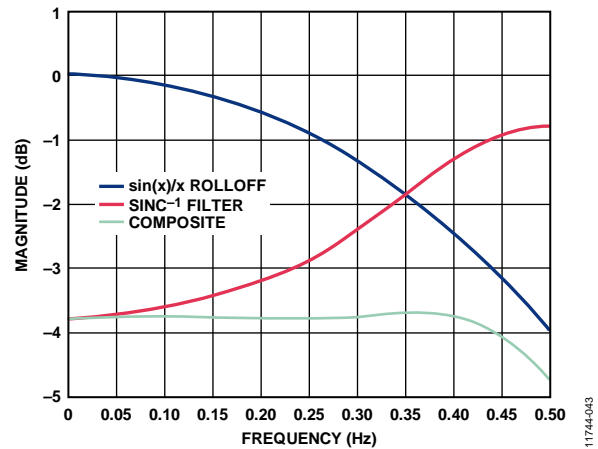

Figure 38. Responses of $\text{sin}(x)/x$ Roll-Off (Blue), Sinc^{-1} Filter (Red), and Composite of Both (Black)

Table 17. Inverse Sinc Filter

Lower Coefficient	Upper Coefficient	Integer Value
H(1)	H(7)	-1
H(2)	H(6)	+4
H(3)	H(5)	-16
H(4)		+192

DIGITAL FUNCTION CONFIGURATION

The inverse sinc filter can be enabled or disabled. The pipeline latency of the DAC is dependent on which of the digital function blocks are enabled or disabled. If fixed DAC pipeline latency is desired during operation, leave each digital function block always enabled or always disabled after initial configuration.

MULTIDEVICE SYNCHRONIZATION AND FIXED LATENCY

A DAC introduces a variation of pipeline latency to a system. The latency variation causes the phase of a DAC output to vary from power-on to power-on. Therefore, the output from different DAC devices may not be perfectly aligned even with well aligned clocks and digital inputs. The skew between multiple DAC outputs varies from power-on to power-on.

In applications such as transmit diversity or digital predistortion, where deterministic latency is desired, the variation of the pipeline latency must be minimized. Deterministic latency in this data sheet is defined as a fixed time delay from the digital input to the analog output in a DAC from power-on to power-on. Multiple DAC devices are considered synchronized to each other when each DAC in this group has the same constant latency from power-on to power-on. Three conditions must be identical in all of the ready-to-sync devices before these devices are considered synchronized:

- The phase of DAC internal clocks
- The FIFO level
- The alignment of the input data

VERY SMALL INHERENT LATENCY VARIATION

The innovative architecture of the AD9139 minimizes the inherent latency variation. The worst-case variation in the AD9139 is two DAC clock cycles. For example, in the case of a 1.6 GHz sample rate, the variation is less than 1.25 ns in any scenario. Therefore, without turning on the synchronization engine, the DAC outputs from multiple AD9139 devices are guaranteed to be aligned within two DAC clock cycles, regardless of the timing between the DCI and the DACCLK. No additional clocks are required to achieve this accuracy. The user must reset the FIFO in each DAC device through the SPI at startup. Therefore, the AD9139 can decrease the complexity of system design in multiple transmit channel applications.

Note the alignment of the DCI signals in the design. The DCI signal is used as a reference in the AD9139 design to align the FIFO and the phase of internal clocks in multiple parts. The achieved DAC output alignment depends on how well the DCI signals are aligned at the input of each device. The following equation is the expression of the worst-case DAC output alignment accuracy in the case of DCI signal mismatches:

$$t_{SK(OUT)} = t_{SK(DCI)} + 2/f_{DAC}$$

where:

$t_{SK(OUT)}$ is the worst-case skew between the DAC outputs from two AD9139 devices.

$t_{SK(DCI)}$ is the skew between two DCI signals at the DCI input of the two AD9139 devices.

f_{DAC} is the DACCLK frequency.

The better the alignment of the DCI signals, the smaller the overall skew between the two DAC outputs.

FURTHER REDUCING THE LATENCY VARIATION

For applications that require finer synchronization accuracy (DAC latency variation < 2 DAC clock cycles), the AD9139 has a provision for enabling multiple devices to be synchronized to each other within a single DAC clock cycle.

To reduce further the latency variation in the DAC, the synchronization machine must be turned on and two external clocks (frame and sync) must be generated in the system and fed to all the DAC devices.

Setup and Hold Timing Requirement

The sync clock (SYNCCLK) serves as a reference clock in the system to reset the clock generation circuitry in multiple AD9139 devices simultaneously. Inside the DAC, the sync clock is sampled by the DACCLK to generate a reference point for aligning the internal clocks; consequently, there is a setup and hold timing requirement between the sync clock and the DAC clock.

Adopting the continuous frame reset mode (where the FIFO and sync engine periodically reset) demands meeting the timing requirements between the sync clock and the DAC clock; otherwise, the device can lose lock and corrupt the output. In the one shot frame reset mode, it is still recommended that this timing be met at the time when the sync routine is run because not meeting the timing can degrade the sync alignment accuracy by one DAC clock cycle, as shown in Table 18.

The AD9139 also provides a mode by which to synchronize the device in a one shot manner and to continue to monitor the synchronization status. It provides a continuous sync and frame clock to synchronize the device once and ignore the clock cycles after detecting the first valid frame pulse. In this way, the user can monitor the sync status without periodically resynchronizing the device; to engage one shot sync mode, set Register 0x22[2] to 0.

Table 18. Sync Clock and DAC Clock Setup and Hold Times

Falling Edge Sync Timing (Default)	Min (ps)
t_s (ns)	324
t_H (ns) ¹	-92
$ t_s + t_H $ (ns)	232

¹ The negative sign indicates the direction of the setup time. The setup time is defined as positive when it is on the left side of the clock edge and negative when it is on the right side of the clock edge.

SYNCHRONIZATION IMPLEMENTATION

The AD9139 allows the user to choose either the rising or falling edge of the DAC clock to sample the sync clock, which makes it easier to meet the timing requirements. Ensure that the sync clock, f_{SYNC} , is $1/8 \times f_{DCI}$ or slower by a factor of $2n$, n being an integer (1, 2, 3...). Note that there is a limit on how slow the sync clock can be because of the ac coupling nature of the sync clock receiver. Choose an appropriate value of the ac coupling capacitors to ensure that the signal swing meets the data sheet specification, as listed in Table 2.

The frame clock resets the FIFO in multiple AD9139 devices. The frame can be either a one shot or continuous clock. In either case, the pulse width of the frame must be longer than one DCI cycle in the word mode and two DCI cycles in the byte mode. When the frame is a continuous clock, f_{FRAME} , ensure that it is $1/8 \times f_{\text{DCI}}$ or slower by a factor of $2n$, n being an integer (1, 2, 3...). One shot frame reset is the recommended method. Because the DCI and the DAC clock are generated in two separate clock domains, timing drifts between the two clocks can cause the FIFO level to toggle between two values in the continuous reset mode and, thus, to corrupt the DAC output. Table 19 lists the requirements of the frame clock in various conditions.

Table 19. Frame Clock Speed and Pulse Width Requirement

Sync Clock	Maximum Speed	Minimum Pulse Width
One Shot	N/A ¹	For both one shot and continuous sync clocks, word mode = one DCI cycle, and byte mode = two DCI cycles.
Continuous	$f_{\text{DCI}}/8$	

¹ N/A means not applicable.

SYNCHRONIZATION PROCEDURES

When the sync accuracy of an application is less precise than two DAC clock cycles, it is recommended to turn off the synchronization machine because no additional steps are required, other than the regular start-up procedure sequence.

For applications that require more precise sync accuracy than two DAC clock cycles, use the procedures in the following sections to set up the system and configure the device.

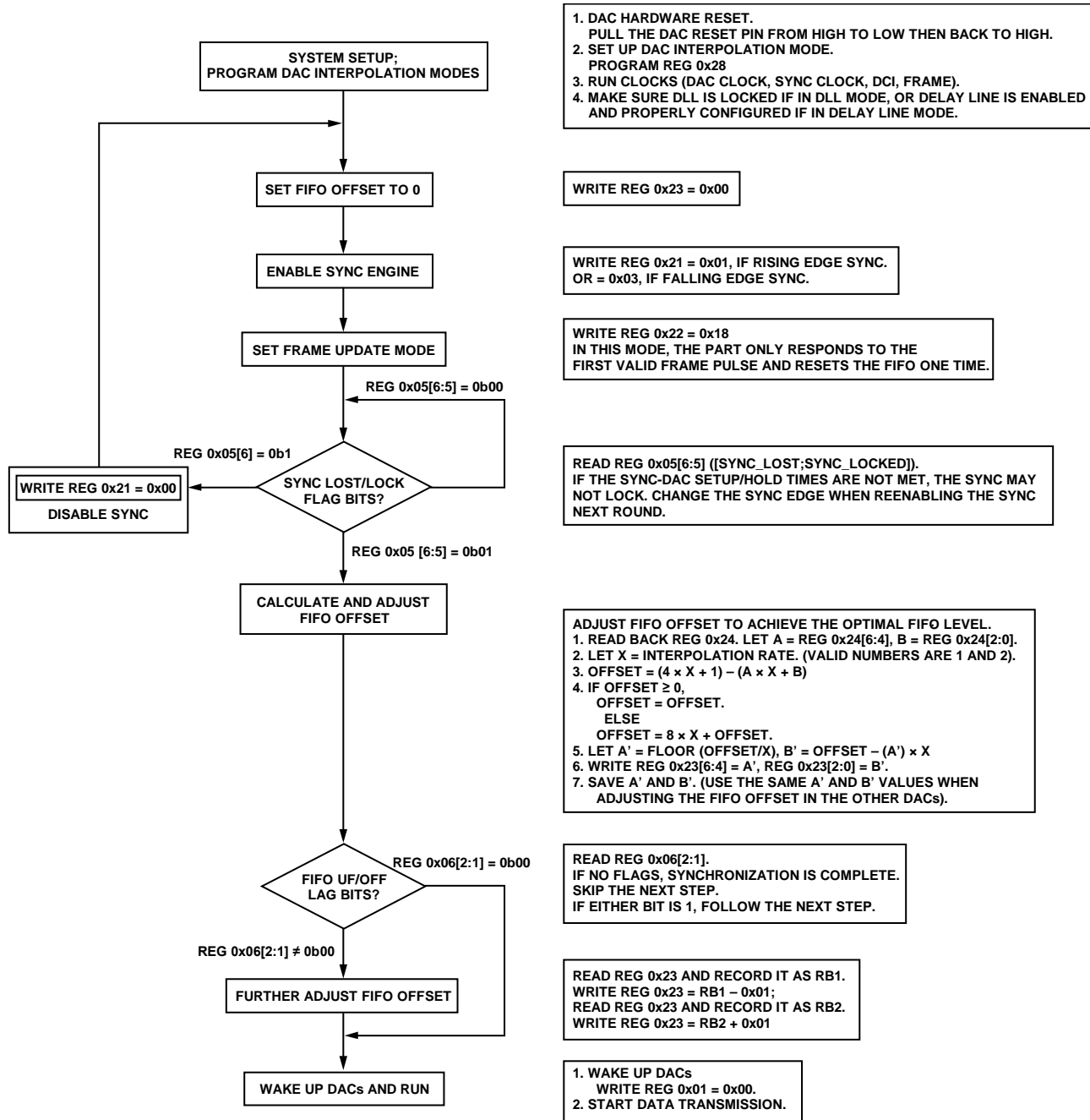

1. DAC HARDWARE RESET.
PULL THE DAC RESET PIN FROM HIGH TO LOW THEN BACK TO HIGH.
2. SET UP DAC INTERPOLATION MODE.
PROGRAM REG 0x28
3. RUN CLOCKS (DAC CLOCK, SYNC CLOCK, DCI, FRAME).
4. MAKE SURE DLL IS LOCKED IF IN DLL MODE, OR DELAY LINE IS ENABLED AND PROPERLY CONFIGURED IF IN DELAY LINE MODE.

WRITE REG 0x23 = 0x00

WRITE REG 0x21 = 0x01, IF RISING EDGE SYNC.
OR = 0x03, IF FALLING EDGE SYNC.

WRITE REG 0x22 = 0x18
IN THIS MODE, THE PART ONLY RESPONDS TO THE FIRST VALID FRAME PULSE AND RESETS THE FIFO ONE TIME.

READ REG 0x05[6:5] ((SYNC_LOST;SYNC_LOCKED)).
IF THE SYNC-DAC SETUP/HOLD TIMES ARE NOT MET, THE SYNC MAY NOT LOCK. CHANGE THE SYNC EDGE WHEN REENABLING THE SYNC NEXT ROUND.

ADJUST FIFO OFFSET TO ACHIEVE THE OPTIMAL FIFO LEVEL.
1. READ BACK REG 0x24. LET A = REG 0x24[6:4], B = REG 0x24[2:0].
2. LET X = INTERPOLATION RATE. (VALID NUMBERS ARE 1 AND 2).
3. OFFSET = (4 × X + 1) – (A × X + B)
4. IF OFFSET ≥ 0,
 OFFSET = OFFSET.
 ELSE
 OFFSET = 8 × X + OFFSET.
5. LET A' = FLOOR (OFFSET/X), B' = OFFSET – (A') × X
6. WRITE REG 0x23[6:4] = A', REG 0x23[2:0] = B'.
7. SAVE A' AND B'. (USE THE SAME A' AND B' VALUES WHEN ADJUSTING THE FIFO OFFSET IN THE OTHER DACs).

READ REG 0x06[2:1].
IF NO FLAGS, SYNCHRONIZATION IS COMPLETE.
SKIP THE NEXT STEP.
IF EITHER BIT IS 1, FOLLOW THE NEXT STEP.

READ REG 0x23 AND RECORD IT AS RB1.
WRITE REG 0x23 = RB1 – 0x01;
READ REG 0x23 AND RECORD IT AS RB2.
WRITE REG 0x23 = RB2 + 0x01

1. WAKE UP DACs
WRITE REG 0x01 = 0x00.
2. START DATA TRANSMISSION.

Figure 39. Synchronization Procedure Diagram

11744-004

INTERRUPT REQUEST OPERATION

The AD9139 provides an interrupt request output signal on Pin 50 and Pin 51 ($\overline{\text{IRQ2}}$ and $\overline{\text{IRQ1}}$, respectively) to notify an external host processor of significant device events. Upon assertion of the interrupt, query the device to determine the precise event that occurred. The $\overline{\text{IRQ1}}$ pin and $\overline{\text{IRQ2}}$ pin are open-drain, active low outputs. Pull the $\overline{\text{IRQx}}$ pin high (DVDD18 supply) external to the device. The $\overline{\text{IRQx}}$ pin can be tied to the interrupt pins of other devices with open-drain outputs to wire-OR these pins together.

Eleven event flags provide visibility into the device. These flags are located in the two event flag registers, Register 0x05 and Register 0x06. The behavior of each event flag is independently selected in the interrupt enable registers, Register 0x03 and Register 0x04. When the flag interrupt enable is active, the event flag latches and triggers the $\overline{\text{IRQ1}}$ and/or $\overline{\text{IRQ2}}$ pins. When the flag interrupt is disabled, the event flag monitors the source signal, but the $\overline{\text{IRQ1}}$ and $\overline{\text{IRQ2}}$ pins remain inactive.

INTERRUPT WORKING MECHANISM

Figure 40 shows the interrupt related circuitry and how the event flag signals propagate to the $\overline{\text{IRQx}}$ output. The `INTERRUPT_ENABLE` signal represents one bit from the interrupt enable register. The `EVENT_FLAG_SOURCE` signal represents one bit from the event flag register. The `EVENT_FLAG_SOURCE` signal represents one of the device signals that can be monitored, such as the `PLL_LOCK` signal from the PLL phase detector or the `FIFO_OVERFLOW` signal from the FIFO controller.

When an interrupt enable bit is set high, the corresponding event flag bit reflects a positively tripped version of the `EVENT_FLAG_SOURCE` signal; that is, the event flag bit is latched on the rising edge of the `EVENT_FLAG_SOURCE` signal. This signal also asserts the external $\overline{\text{IRQx}}$ pins.

When an interrupt enable bit is set low, the event flag bit reflects the present status of the `EVENT_FLAG_SOURCE` signal, and the event flag has no effect on the external $\overline{\text{IRQx}}$ pins.

Clear the latched version of an event flag (the `INTERRUPT_SOURCE` signal) in one of two ways. The recommended

method is by writing 1 to the corresponding event flag bit. The second method is to use a hardware or software reset to clear the `INTERRUPT_SOURCE` signal.

The $\overline{\text{IRQ2}}$ circuitry works in the same way as the $\overline{\text{IRQ1}}$ circuitry. Any one or multiple event flags can be enabled to trigger the $\overline{\text{IRQx}}$ pins. The user can select one or both hardware interrupt pins for the enabled event flags. Register 0x07 and Register 0x08 determine the pin to which each event flag is routed. Set Register 0x07 and Register 0x08 to 0 for $\overline{\text{IRQ1}}$ and set these registers to 1 for $\overline{\text{IRQ2}}$.

INTERRUPT SERVICE ROUTINE

Interrupt request management starts by selecting the set of event flags that require host intervention or monitoring. Enable the events that require host action so that the host is notified when they occur. For events requiring host intervention upon $\overline{\text{IRQx}}$ activation, run the following routine to clear an interrupt request:

1. Read the status of the event flag bits that are being monitored.
2. Set the interrupt enable bit low to monitor the unlatched `EVENT_FLAG_SOURCE` signal directly.
3. Perform any actions that may be required to clear the `EVENT_FLAG_SOURCE` signal. In many cases, no specific actions are required.
4. Read the event flag to verify that the actions taken have cleared the `EVENT_FLAG_SOURCE` signal.
5. Clear the interrupt by writing 1 to the event flag bit.
6. Set the interrupt enable bits of the events to be monitored.

Note that some `EVENT_FLAG_SOURCE` signals are latched signals. Clear these signals by writing to the corresponding event flag bit. For more information about each of the event flags, see the Device Configuration Register Map and Description section.

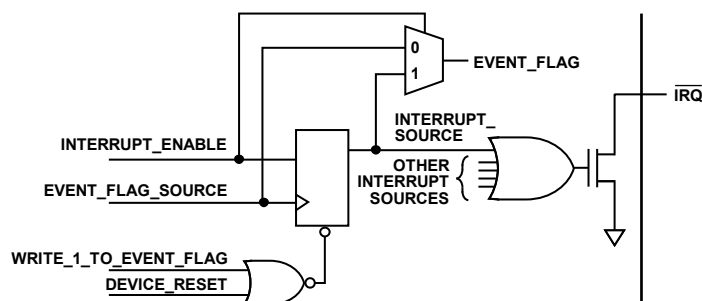

Figure 40. Simplified Schematic of $\overline{\text{IRQx}}$ Circuitry

TEMPERATURE SENSOR

The AD9139 has a diode-based temperature sensor for measuring the temperature of the die. The temperature reading is accessed using Register 0x1D and Register 0x1E. The temperature of the die can be calculated as

$$T_{DIE} = \frac{(DIETEMP[15:0] - 41,237)}{106}$$

where T_{DIE} is the die temperature in degrees Celsius.

The temperature accuracy is $\pm 7^{\circ}\text{C}$ typical over the -40°C to $+85^{\circ}\text{C}$ range with one point temperature calibration against a known temperature. See Figure 41 for a typical plot of the die temperature code readback vs. die temperature.

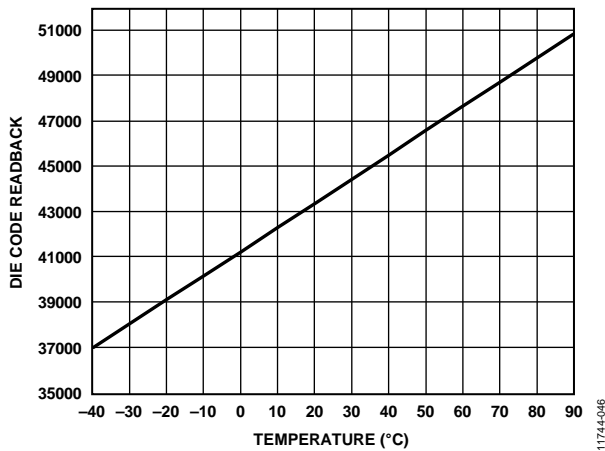

Figure 41. Die Temperature Code Readback vs. Die Temperature

Estimates of the ambient temperature can be made if the power dissipation of the device is known. For example, if the device power dissipation is 800 mW and the measured die temperature is 50°C , then calculate the ambient temperature as

$$T_A = T_{DIE} - P_D \times \theta_{JA} = 50 - 0.8 \times 20.7 = 33.4^{\circ}\text{C}$$

where:

T_A is the ambient temperature in degrees Celsius.

T_{DIE} is the die temperature in degrees Celsius.

P_D is power consumption of the device.

θ_{JA} is the thermal resistance from junction to ambient of the AD9139, as shown in Table 7.

To use the temperature sensor, it must be enabled by setting Register 0x1C[0] to 1. In addition, to obtain accurate readings, set the die temperature control register (Register 0x1C) to 0x03.

DAC INPUT CLOCK CONFIGURATIONS

The AD9139 DAC sample clock (DACCLK) can be sourced directly or by clock multiplying. Clock multiplying employs the on-chip phase-locked loop (PLL) that accepts a reference clock operating at a submultiple of the desired DACCLK rate. The PLL then multiplies the reference clock up to the desired DACCLK frequency, which then generates all of the internal clocks required by the DAC. The clock multiplier provides a high quality clock that meets the performance requirements of most applications. Using the on-chip clock multiplier removes the burden of generating and distributing the high speed DACCLK.

The second mode bypasses the clock multiplier circuitry and sources DACCLK directly to the DAC core. This mode lets the user source a very high quality clock directly to the DAC core.

DRIVING THE DACCLK AND REFCLK INPUTS

The DACCLKx and REFCLKx differential inputs share similar clock receiver input circuitry (see Figure 42 for a simplified circuit diagram of the input). The on-chip clock receiver has a differential input impedance of about 10 k Ω . It is self biased to a common-mode voltage of about 1.25 V. Drive the inputs by differential PECL or LVDS drivers with ac coupling between the clock source and the receiver.

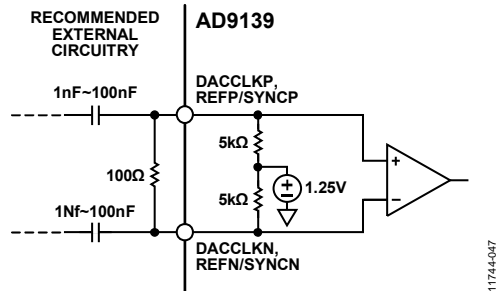

Figure 42. Clock Receiver Input Simplified Equivalent Circuit

The minimum input drive level to the differential clock input is 100 mV p-p differential. The optimal performance is achieved when the clock input signal is between 800 mV p-p differential and 1.6 V p-p differential. Whether using the on-chip clock multiplier or sourcing the DACCLK directly, the input clock signal to the device must have low jitter and fast edge rates to optimize the DAC noise performance.

DIRECT CLOCKING

Direct clocking with a low noise clock produces the lowest noise spectral density at the DAC outputs. To select the differential clock inputs as the source for the DAC sampling clock, set the PLL enable bit (Register 0x12[7]) to 0. This powers down the internal PLL clock multiplier and selects the input from the DACCLKP and DACCLKN pins as the source for the internal DAC sampling clock. The REFCLKx input can remain floating.

The device also has clock duty cycle correction circuitry and differential input level correction circuitry. Enabling these circuits can provide improved performance in some cases. The control bits for these functions are in Register 0x10 and Register 0x11.

CLOCK MULTIPLICATION

The on-chip PLL clock multiplier circuit generates the DAC sample rate clock from a lower frequency reference clock. When the PLL enable bit (Register 0x12[7]) is set to 1, the clock multiplication circuit generates the DAC sampling clock from the lower rate REFCLK input and the DACCLKx input remains floating. See Figure 43 for the functional diagram of the clock multiplier.

The clock multiplier circuit operates such that the VCO outputs a frequency, f_{VCO} , equal to the REFCLKx input signal frequency multiplied by $N1 \times N0$. $N1$ is the divide ratio of the loop divider; $N0$ is the divide ratio of the VCO divider.

$$f_{VCO} = f_{REFCLK} \times (N1 \times N0)$$

The DAC sample clock frequency, f_{DACCLK} , is equal to

$$f_{DACCLK} = f_{REFCLK} \times N1$$

The output frequency of the VCO must be chosen to keep f_{VCO} in the optimal operating range of 1.0 GHz to 2.1 GHz. It is important to select a frequency of the reference clock and values of $N1$ and $N0$ so that the desired DACCLK frequency can be synthesized and the VCO output frequency is in the correct range.

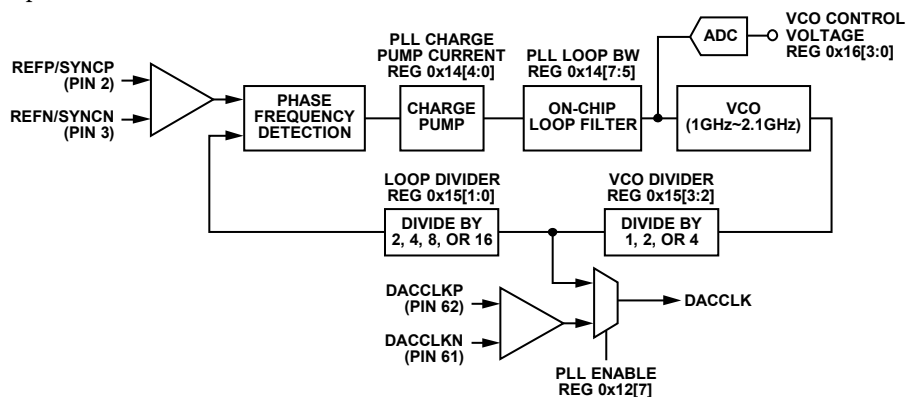

Figure 43. PLL Clock Multiplier Circuit

PLL SETTINGS

The PLL circuitry requires three settings to be programmed to their nominal values. The PLL values listed in Table 20 are the recommended settings for these parameters.

Table 20. PLL Settings

PLL SPI Control Register	Register Address	Optimal Setting (Binary)
PLL Loop Bandwidth	0x14[7:5]	111
PLL Charge Pump Current	0x14[4:0]	00111
PLL Cross Point Control Enable	0x15[4]	0

CONFIGURING THE VCO TUNING BAND

The PLL VCO has a valid operating range from approximately 1.03 GHz to 2.07 GHz covered in 64 overlapping frequency bands. For any desired VCO output frequency, there may be several valid PLL band select values. See Figure 44 for the frequency bands of a typical device. Device-to-device variations and operating temperature affect the actual band frequency range. Therefore, it is necessary to determine the optimal PLL band select value for each individual device.

AUTOMATIC VCO BAND SELECT

The device has an automatic VCO band select feature on chip. Using the automatic VCO band select feature is a simple and reliable method of configuring the VCO frequency band. Enable this feature by starting the PLL in manual mode and then placing the PLL in autoband select mode by setting Register 0x12 to a value of 0xC0 and then to a value of 0x80. When these values are written, the device executes an automated routine that determines the optimal VCO band setting for the device.

The setting selected by the device ensures that the PLL remains locked over the full -40°C to $+85^{\circ}\text{C}$ operating temperature range of the device without further adjustment. The PLL remains locked over the full temperature range even if the temperature during initialization is at one of the temperature extremes.

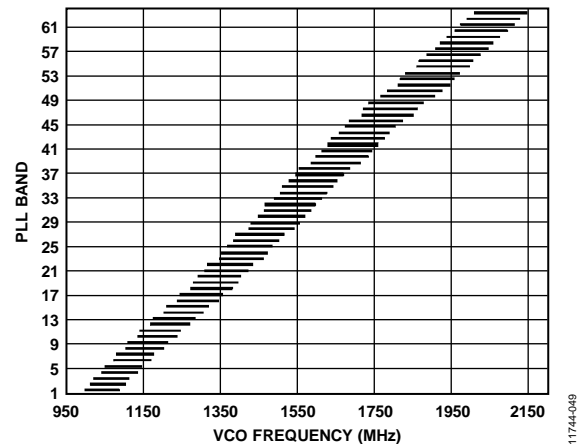

Figure 44. PLL Lock Range for a Typical Device

MANUAL VCO BAND SELECT

The device includes a manual band select mode (PLL auto manual enable, Register 0x12[6] = 1) that lets the user select the VCO tuning band. In manual mode, the VCO band is set directly with the value written to the manual VCO band bits (Register 0x12[5:0]).

PLL ENABLE SEQUENCE

To enable the PLL in automatic or manual mode properly, the following sequence must be followed:

Automatic Mode Sequence

1. Configure the loop divider and the VCO divider registers for the desired divide ratios.
2. Set 00111 to PLL charge pump current and 111 to PLL loop bandwidth for the best performance. Register 0x14 = 0xE7 (default).
3. Set the PLL mode to manual using Register 0x12[6] = 1.
4. Enable the PLL using Register 0x12[7] = 1.
5. Set the PLL mode to automatic using Register 0x12[6] = 0.

Manual Mode

1. Configure the loop divider and the VCO divider registers for the desired divide ratios.
2. Set 00111 to PLL charge pump current and 111 to PLL loop bandwidth for the best performance. Register 0x14 = 0xE7 (default).
3. Select the desired band using Register 0x12[5:0].
4. Set the PLL mode to manual using Register 0x12[6] = 1.
5. Enable the PLL using Register 0x12[7] = 1.

ANALOG OUTPUTS

TRANSMIT DAC OPERATION

Figure 45 shows a simplified block diagram of the transmit path DACs. The DAC core consists of a current source array, a switch core, digital control logic, and full-scale output current control. The DAC full-scale output current (I_{OUTFS}) is nominally 20 mA. The output currents from the DACOUTP and DACOUTN pins are complementary, meaning that the sum of the two currents always equals the full-scale current of the DAC. The digital input code to the DAC determines the effective differential current delivered to the load.

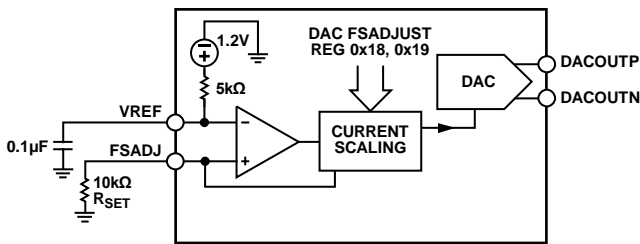

Figure 45. Simplified Block Diagram of DAC Core

The DAC has a 1.2 V band gap reference with an output impedance of 5 kΩ. The reference output voltage appears on the VREF pin. When using the internal reference, decouple the VREF pin to AVSS with a 0.1 μF capacitor. Use the internal reference only for external circuits that draw dc currents of 2 μA or less. For dynamic loads or static loads greater than 2 μA, buffer the VREF pin. If desired, the internal reference can be overdriven by applying an external reference (from 1.10 V to 1.30 V) to the pin.

A 10 kΩ external resistor, R_{SET} , must be connected from the FSADJ pin to AVSS. This resistor, together with the reference control amplifier, sets up the correct internal bias currents for the DAC. Because the full-scale current is inversely proportional to this resistor, the tolerance of R_{SET} is reflected in the full-scale output amplitude.

The full-scale current equation, where the DAC gain is set in Register 0x18 and Register 0x19, is as follows:

$$I_{FS} = \frac{V_{REF}}{R_{SET}} \times \left(72 + \left(\frac{3}{16} \times DAC \text{ gain} \right) \right)$$

For nominal values of V_{REF} (1.2 V), R_{SET} (10 kΩ), and DAC gain (512), the full-scale current of the DAC is typically 20 mA. The DAC full-scale current is adjustable from 8.64 mA to 31.68 mA by setting the DAC gain parameter, as shown in Figure 46.

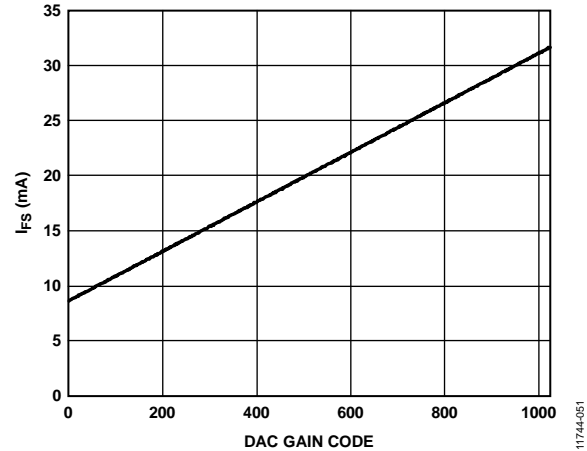

Figure 46. DAC Full-Scale Current vs. DAC Gain Code

Transmit DAC Transfer Function

The output currents from the DACOUTP and DACOUTN pins are complementary, meaning that the sum of the two currents always equals the full-scale current of the DAC. The digital input code to the DAC determines the effective differential current delivered to the load. The DACOUTP pin provides maximum output current when all bits are high. The output currents vs. DACCODE for the DAC outputs is expressed as

$$I_{OUTP} = \left[\frac{DACCODE}{2^N} \right] \times I_{OUTFS} \quad (1)$$

$$I_{OUTN} = I_{OUTFS} - I_{OUTP} \quad (2)$$

where $DACCODE = 0$ to $2^N - 1$.

Transmit DAC Output Configurations

The optimum noise and distortion performance of the AD9139 is realized when it is configured for differential operation. The common-mode rejection of a transformer or differential amplifier significantly reduces the common-mode error sources of the DAC outputs. These common-mode error sources include even-order distortion products and noise. The enhancement in distortion performance becomes more significant as the frequency content of the reconstructed waveform increases and/or its amplitude increases. This is due to the first-order cancellation of various dynamic common-mode distortion mechanisms, digital feed-through, and noise.

Figure 47 shows the most basic DAC output circuitry. A pair of resistors, R_O , converts each of the complementary output currents to a differential voltage output, V_{OUT} . Because the current outputs of the DAC are high impedance, the differential driving point impedance of the DAC outputs, R_{OUT} , is equal to $2 \times R_O$. See Figure 48 for the output voltage waveforms.

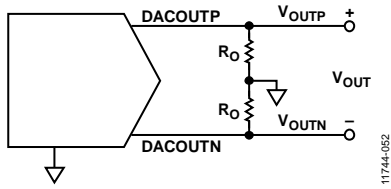

Figure 47. Basic Transmit DAC Output Circuit

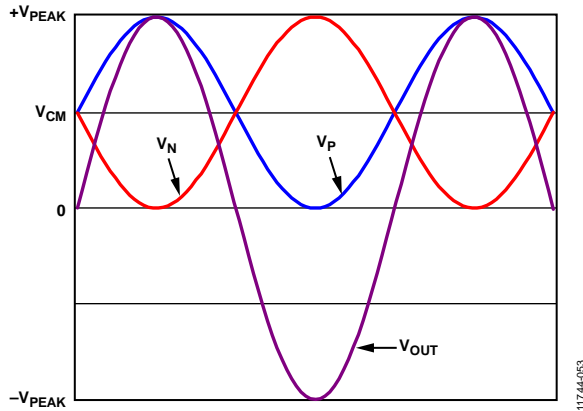

Figure 48. Output Voltage Waveforms

The common-mode signal voltage, V_{CM} , is calculated as

$$V_{CM} = \frac{I_{FS}}{2} \times R_O$$

The differential peak-to-peak output voltage, V_{PEAK} , is calculated as

$$V_{PEAK} = 2 \times I_{FS} \times R_O$$

INTERFACING TO MODULATORS

The AD9139 interfaces to the ADL537x family of modulators with a minimal number of components. An example of the recommended interface circuitry is shown in Figure 49.

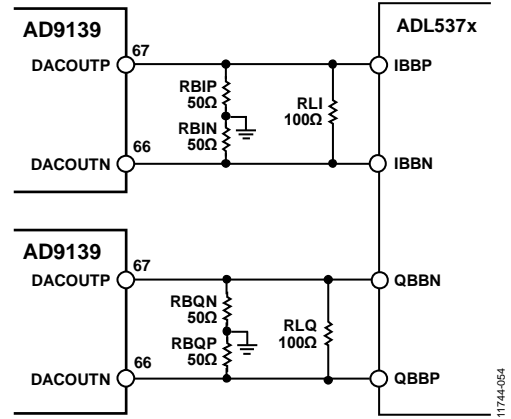

Figure 49. Typical Interface Circuitry Between the AD9139 and the ADL537x Family of Modulators

The baseband inputs of the ADL537x family require a dc bias of 500 mV. The nominal midscale output current on each output of the DAC is 10 mA (one-half the full-scale current). Therefore, a single 50 Ω resistor to ground from each of the DAC outputs results in the desired 500 mV dc common-mode bias for the inputs to the ADL537x. The addition of the load resistor in parallel with the modulator inputs reduces the signal level. The peak-to-peak voltage swing of the transmitted signal is

$$V_{SIGNAL} = I_{FS} \times \frac{(2 \times R_B \times R_L)}{(2 \times R_B + R_L)}$$

Baseband Filter Implementation

Most applications require a baseband anti-imaging filter between the DAC and the modulator to filter out Nyquist images and broadband DAC noise. The filter can be inserted between the termination resistors at the DAC output and the signal level setting resistor across the modulator input. This configuration establishes the input and output impedances for the filter.

Figure 50 shows a fifth-order, low-pass filter. Splitting the filter capacitors into two and grounding the center point creates a common-mode low-pass filter that provides additional common-mode rejection of high frequency signals. A purely differential filter can pass common-mode signals.

For more details about interfacing the AD9139 DAC to an IQ modulator, see the [Circuits from the Lab™](#), [Circuit Note CN-0205, Interfacing the ADL5375 I/Q Modulator to the AD9122 Dual Channel, 1.2 GSPS High Speed DAC](#) on the Analog Devices website.

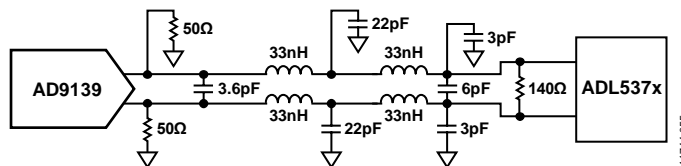

Figure 50. DAC Modulator Interface with Fifth-Order, Low-Pass Filter

REDUCING LO LEAKAGE AND UNWANTED SIDEBANDS

Analog quadrature modulators can introduce unwanted signals at the local oscillator (LO) frequency caused by dc offset voltages in the I and Q baseband inputs, as well as feedthrough paths from the LO input to the output.

Effective sideband suppression requires both gain and phase matching of the I and Q signals. The DAC FS adjust registers

(Register 0x18 through Register 0x19) can be used to calibrate the gain of the transmit paths to optimize sideband suppression.

For more information about suppressing LO leakage and sideband image, refer to [Application Note AN-1039, Correcting Imperfections in IQ Modulators to Improve RF Signal Fidelity](#) and [Application Note AN-1100, Wireless Transmitter IQ Balance and Sideband Suppression](#) from the Analog Devices website.

START-UP ROUTINE

To ensure reliable start up of the AD9139, certain sequences must be followed.

Device Configuration and Start-Up Sequence 1

1. Set $f_{DCI} = 600$ MHz, $f_{DATA} = 1200$ MHz, and interpolation to $1\times$.
2. Enable the PLL, and set $f_{REF} = 300$ MHz.
3. Enable the inverse sinc filter.
4. Use the DLL-based interface mode and set DLL phase offset = 0.

Derived PLL Settings

The following PLL settings are derived from the device configuration:

- $f_{DAC} = 1200 \times 1 = 1200$ MHz.
- $f_{VCO} = f_{DAC} = 1200$ MHz ($1 \text{ GHz} < f_{VCO} < 2 \text{ GHz}$).
- VCO divider = $f_{VCO}/f_{DAC} = 1$.
- Loop divider = $f_{DAC}/f_{REF} = 4$.

Start-Up Sequence 1

1. Power up the device (no specific power supply sequence is required).
2. Apply stable DAC clock.
3. Apply stable DCI clock.
4. Feed stable input data.
5. Issue hardware reset (optional).

```
/* Device configuration register write
sequence */
0x00 → 0x20 /* Issue software reset */
0x20 → 0x01 /* Device Startup Configuration */
/* Configure PLL */
0x14 → 0xE7 /* Configure PLL loop BW and charge
pump current */
0x15 → 0xC1 /* Configure VCO divider and loop
divider */
0x12 → 0xC0 /*Enable the PLL */
0x12 → 0x80
Wait 10ms
Read 0x16[7] /* Expect 1b if the PLL is locked
*/

/* Configure Data Interface */
0x5E → 0xFE /* Turn off LSB delay cell */
0x0A → 0xC0 /* Enable the DLL and duty cycle
correction. Set DLL phase offset to 0 */
Read 0x0E[7:4] /* Expect 1000b if the DLL is
locked */

/* Configure Interpolation filter */
0x28 → 0x80 /* 1× interpolation */
/* Reset FIFO */
0x25 → 0x01
```

```
Read 0x25[1] /* Expect 1b if the FIFO reset is
complete */
```

```
Read 0x24 /* The readback should be one of the
three values: 0x30, 0x40, or 0x50 */
```

```
/* Enable Inverse SINC filter */
0x27 → 0x80
```

```
/* Power up DAC outputs */
0x01 → 0x00
```

Device Configuration and Start-Up Sequence 2

1. Set $f_{DCI} = 200$ MHz, $f_{DATA} = 400$ MHz, $f_{DAC} = 800$ MHz, and interpolation to $2\times$.
2. Disable PLL.
3. Enable the inverse sinc filter.
4. Use the delay line-based interface mode with a delay setting of 0.

Start-Up Sequence 2

1. Power up the device (no specific power supply sequence is required).
2. Apply stable DAC clock.
3. Apply stable DCI clock.
4. Feed stable input data.
5. Issue a hardware reset (optional).

```
/* Device configuration register write
sequence */
0x00 → 0x20 /* Issue software reset */
0x20 → 0x01 /* Device Startup Configuration */

/* Configure Data Interface */
0x5E → 0x00 /* Configure the delay setting */
0x5F → 0x60
0x0D → 0x16 /* DC couple DCI */
0x0A → 0x00 /* Turn off DLL and duty cycle
correction */
/* Configure Interpolation filter */
0x28 → 0x00 /* 2× interpolation */

/* Reset FIFO */
Follow the serial port FIFO reset procedure in
the FIFO Operation section.

/* Enable Inverse SINC filter */
0x27 → 0x80

/* Power up DAC outputs */
0x01 → 0x00
```

DEVICE CONFIGURATION REGISTER MAP AND DESCRIPTION

Table 21. Device Configuration Register Map

Reg	Name	Bits	Bit 7	Bit 6	Bit 5	Bit 4	Bit 3	Bit 2	Bit 1	Bit 0	Reset	RW	
0x00	Common	[7:0]	Reserved	SPI_LSB_FIRST	DEVICE_RESET	Reserved					0x00	RW	
0x01	PD_CONTROL	[7:0]	PD_DAC	Reserved	PD_DATARCV	Reserved		PD_DEVICE	PD_DACCLK	PD_FRAME	0xC0	RW	
0x03	INTERRUPT_ENABLE0	[7:0]	Reserved	ENABLE_SYNC_LOST	ENABLE_SYNC_LOCKED	ENABLE_SYNC_DONE	ENABLE_PLL_LOST	ENABLE_PLL_LOCKED	Reserved		0x00	RW	
0x04	INTERRUPT_ENABLE1	[7:0]	ENABLE_PARITY_FAIL	ENABLE_SED_FAIL	ENABLE_DLL_WARNING	ENABLE_DLL_LOCKED	Reserved	ENABLE_FIFO_UNDERFLOW	ENABLE_FIFO_OVERFLOW	Reserved	0x00	RW	
0x05	INTERRUPT_FLAG0	[7:0]	Reserved	SYNC_LOST	SYNC_LOCKED	SYNC_DONE	PLL_LOST	PLL_LOCKED	Reserved		0x00	R	
0x06	INTERRUPT_FLAG1	[7:0]	PARITY_FAIL	SED_FAIL	DLL_WARNING	DLL_LOCKED	Reserved	FIFO_UNDERFLOW	FIFO_OVERFLOW	Reserved	0x00	R	
0x07	IRQ_SELO	[7:0]	Reserved	SEL_SYNC_LOST	SEL_SYNC_LOCKED	SEL_SYNC_DONE	SEL_PLL_LOST	SEL_PLL_LOCKED	Reserved		0x00	RW	
0x08	IRQ_SEL1	[7:0]	SEL_PARITY_FAIL	SEL_SED_FAIL	SEL_DLL_WARNING	SEL_DLL_LOCKED	Reserved	FIFO_UNDERFLOW	FIFO_OVERFLOW	Reserved	0x00	RW	
0x09	FRAME_MODE	[7:0]	Reserved		PARUSAGE	FRMUSAGE	Reserved		FRAME_PIN_USAGE		0x00	RW	
0x0A	DATA_CNTR_0	[7:0]	DLL_ENABLE	DUTY_CORRECTION_EN	Reserved		DLL_PHASE_OFFSET				0x40	RW	
0x0B	DATA_CNTR_1	[7:0]	CLEAR_WARN	Reserved								0x39	RW
0x0C	DATA_CNTR_2	[7:0]	Reserved									0x64	RW
0x0D	DATA_CNTR_3	[7:0]	LOW_DCL_EN	Reserved		DC_COUPLE_LOW_EN	Reserved					0x06	RW
0x0E	DATA_STAT_0	[7:0]	DLL_LOCK	DLL_WARN	DLL_START_WARNING	DLL_END_WARNING	Reserved	DCI_ON	Reserved	DLL_RUNNING	0x00	R	
0x10	DACCLK_RECEIVER_CTRL	[7:0]	DACCLK_DUTYCYCLE_CORRECTION	Reserved	DACCLK_CROSSPOINT_CTRL_ENABLE	DACCLK_CROSSPOINT_LEVEL					0xFF	RW	
0x11	REFCLK_RECEIVER_CTRL	[7:0]	DUTYCYCLE_CORRECTION	Reserved	REFCLK_CROSSPOINT_CTRL_ENABLE	REFCLK_CROSSPOINT_LEVEL					0x5F	RW	
0x12	PLL_CTRL0	[7:0]	PLL_ENABLE	AUTO_MANUAL_SEL	PLL_MANUAL_BAND						0x00	RW	
0x14	PLL_CTRL2	[7:0]	PLL_LOOP_BW			PLL_CP_CURRENT						0xE7	RW
0x15	PLL_CTRL3	[7:0]	DIGLOGIC_DIVIDER		Reserved	CROSSPOINT_CTRL_EN	VCO_DIVIDER		LOOP_DIVIDER		0xC9	RW	
0x16	PLL_STATUS0	[7:0]	PLL_LOCK	Reserved		VCO_CTRL_VOLTAGE_READBACK					0x00	R	
0x17	PLL_STATUS1	[7:0]	Reserved		PLL_BAND_READBACK						0x00	R	
0x18	DAC_FS_ADJ0	[7:0]	DAC_FULLSCALE_ADJUST_LSB									0xF9	RW
0x19	DAC_FS_ADJ1	[7:0]	BG_TRIM			RESERVED			DAC_FULLSCALE_ADJUST_MSB			0xE1	RW
0x1C	DIE_TEMP_SENSOR_CTRL	[7:0]	Reserved	FS_CURRENT			REF_CURRENT			DIE_TEMP_SENSOR_EN	0x02	RW	
0x1D	DIE_TEMP_LSB	[7:0]	DIE_TEMP_LSB									0x00	R
0x1E	DIE_TEMP_MSB	[7:0]	DIE_TEMP_MSB									0x00	R
0x1F	CHIP_ID	[7:0]	CHIP_ID									0x0A	R
0x20	INTERRUPT_CONFIG	[7:0]	INTERRUPT_CONFIGURATION									0x00	RW
0x21	SYNC_CTRL	[7:0]	Reserved						SYNC_CLK_EDGE_SEL	SYNC_ENABLE	0x00	RW	
0x22	FRAME_RST_CTRL	[7:0]	Reserved				ARM_FRAME	EN_CON_FRAME_RESET	FRAME_RESET_MODE			0x12	RW
0x23	FIFO_LEVEL_CONFIG	[7:0]	Reserved	INTEGER_FIFO_LEVEL_REQUEST			Reserved	FRACTIONAL_FIFO_LEVEL_REQUEST				0x40	RW
0x24	FIFO_LEVEL_READBACK	[7:0]	Reserved	INTEGER_FIFO_LEVEL_READBACK			Reserved	FRACTIONAL_FIFO_LEVEL_READBACK				0x00	R
0x25	FIFO_CTRL	[7:0]	Reserved						FIFO_SPI_RESET_ACK	FIFO_SPI_RESET_REQUEST	0x00	RW	
0x26	DATA_FORMAT_SEL	[7:0]	DATA_FORMAT	Reserved							DATA_BUS_WIDTH	0x00	RW
0x27	DATAPATH_CTRL	[7:0]	INVSINC_ENABLE	Reserved	DIG_GAIN_DCOFFSET_ENABLE	Reserved					0x00	RW	

Reg	Name	Bits	Bit 7	Bit 6	Bit 5	Bit 4	Bit 3	Bit 2	Bit 1	Bit 0	Reset	RW	
0x28	INTERPOLATION_CTRL	[7:0]	INTERPOLATION_MODE	Reserved								0x00	RW
0x39	LVDS_IN_PWR_DOWN_0	[7:0]	Reserved				PWR_DOWN_DATA_INPUT_BITS				0x00	RW	
0x3B	DAC_DC_OFFSET0	[7:0]	DAC_DC_OFFSET_LSB								0x00	RW	
0x3C	DAC_DC_OFFSET1	[7:0]	DAC_DC_OFFSET_MSB								0x00	RW	
0x3F	DAC_DIG_GAIN	[7:0]	Reserved			DAC_DIG_GAIN					0x20	RW	
0x41	GAIN_STEP_CTRL0	[7:0]	Reserved			RAMP_UP_STEP					0x01	RW	
0x42	GAIN_STEP_CTRL1	[7:0]	DAC_OUTPUT_STATUS	DAC_OUTPUT_ON	RAMP_DOWN_STEP							0x01	RW
0x43	TX_ENABLE_CTRL	[7:0]	Reserved					TXENABLE_GAINSTEP_EN	TXENABLE_SLEEP_EN	TXENABLE_POWER_DOWN_EN	0x07	RW	
0x44	DAC_OUTPUT_CTRL	[7:0]	DAC_OUTPUT_CTRL_EN	Reserved			FIFO_WARNING_SHUTDOWN_EN	Reserved		FIFO_ERROR_SHUTDOWN_EN	0x8F	RW	
0x5E	ENABLE_DLL_DELAY_CELLO	[7:0]	ENABLE_DLL_DELAY_CELL[7:0]								0xFF		
0x5F	ENABLE_DLL_DELAY_CELL1	[7:0]	Reserved					ENABLE_DLL_DELAY_CELL[10:8]				0x67	RW
0x60	SED_CTRL	[7:0]	SED_ENABLE	SED_ERR_CLEAR	AED_ENABLE	SED_DEPTH	Reserved	AED_PASS	AED_FAIL	SED_FAIL	0x00	RW	
0x61	SED_PATT_L_S0	[7:0]	SED_PATTERN_RISE_S0 [7:0]								0x00	RW	
0x62	SED_PATT_H_S0	[7:0]	SED_PATTERN_RISE_S0 [15:8]								0x00	RW	
0x63	SED_PATT_L_S1	[7:0]	SED_PATTERN_FALL_S1 [7:0]								0x00	RW	
0x64	SED_PATT_H_S1	[7:0]	SED_PATTERN_FALL_S1 [15:8]								0x00	RW	
0x65	SED_PATT_L_S2	[7:0]	SED_PATTERN_RISE_S2 [7:0]								0x00	RW	
0x66	SED_PATT_H_S2	[7:0]	SED_PATTERN_RISE_S2 [15:8]								0x00	RW	
0x67	SED_PATT_LS3	[7:0]	SED_PATTERN_FALL_S3 [7:0]								0x00	RW	
0x68	SED_PATT_HS3	[7:0]	SED_PATTERN_FALL_S3 [15:8]								0x00	RW	
0x6A	PARITY_CTRL	[7:0]	PARITY_ENABLE	PARITY_EVEN	PARITY_ERR_CLEAR	Reserved			PARERRFAL	PARERRRIS	0x00	RW	
0x6B	PARITY_ERR_RISING	[7:0]	PARITY RISING EDGE ERROR COUNT								0x00	R	
0x6C	PARITY_ERR_FALLING	[7:0]	PARITY FALLING EDGE ERROR COUNT								0x00	R	
0x7F	Version	[7:0]	Version								0x07	R	

SPI CONFIGURE REGISTER

Address: 0x00, Reset: 0x00, Name: Common

Table 22. Bit Descriptions for Common

Bit No.	Bit Name	Settings	Description	Reset	Access
6	SPI_LSB_FIRST	0	Serial port communication, MSB first or LSB first selection. MSB first.	0	R/W
		1	LSB first.		
5	DEVICE_RESET		The device resets when 1 is written to this bit. DEVICE_RESET is a self clear bit. After the reset, the bit returns to 0 automatically. The readback is always 0.	0	R/W

POWER-DOWN CONTROL REGISTER

Address: 0x01, Reset: 0xC0, Name: PD_CONTROL

Table 23. Bit Descriptions for PD_CONTROL

Bit No.	Bit Name	Settings	Description	Reset	Access
7	PD_DAC		The DAC is powered down when PD_DAC is set to 1. This bit powers down only the analog portion of the DAC. The DAC digital data path is not affected.	1	R/W
6	Reserved		Must set to default value.	1	R/W
5	PD_DATARCV		The data interface circuitry is powered down when PD_DATARCV is set to 1. This bit powers down the data interface and the write side of the FIFO.	0	R/W
2	PD_DEVICE		The band gap circuitry is powered down when set to 1. This bit powers down the entire chip.	0	R/W
1	PD_DACCLK		The DAC clock powers down when PD_DEVICE is set to 1. This bit powers down the DAC clocking path and, thus, the majority of the digital functions.	0	R/W
0	PD_FRAME		The frame receiver powers down when PD_FRAME is set to 1. The frame signal is internally pulled low. Set to 1 when frame is not used.	0	R/W

INTERRUPT ENABLE 0 REGISTER

Address: 0x03, Reset: 0x00, Name: INTERRUPT_ENABLE0

Table 24. Bit Descriptions for INTERRUPT_ENABLE0

Bit No.	Bit Name	Settings	Description	Reset	Access
6	ENABLE_SYNC_LOST		Enable interrupt for sync lost.	0	R/W
5	ENABLE_SYNC_LOCKED		Enable interrupt for sync lock.	0	R/W
4	ENABLE_SYNC_DONE		Enable interrupt for sync done.	0	R/W
3	ENABLE_PLL_LOST		Enable interrupt for PLL lost.	0	R/W
2	ENABLE_PLL_LOCKED		Enable interrupt for PLL locked.	0	R/W

INTERRUPT ENABLE 1 REGISTER

Address: 0x04, Reset: 0x00, Name: INTERRUPT_ENABLE1

Table 25. Bit Descriptions for INTERRUPT_ENABLE1

Bit No.	Bit Name	Settings	Description	Reset	Access
7	ENABLE_PARITY_FAIL		Enable interrupt for parity failure	0	R/W
6	ENABLE_SED_FAIL		Enable interrupt for SED failure	0	R/W
5	ENABLE_DLL_WARNING		Enable interrupt for DLL warning.	0	R/W
4	ENABLE_DLL_LOCKED		Enable interrupt for DLL locked.	0	R/W
2	ENABLE_FIFO_UNDERFLOW		Enable interrupt for FIFO underflow.	0	R/W
1	ENABLE_FIFO_OVERFLOW		Enable interrupt for FIFO overflow.	0	R/W

INTERRUPT FLAG 0 REGISTER

Address: 0x05, Reset: 0x00, Name: INTERRUPT_FLAG0

Table 26. Bit Descriptions for INTERRUPT_FLAG0

Bit No.	Bit Name	Settings	Description	Reset	Access
6	SYNC_LOST		SYNC_LOST is set to 1 when sync is lost.	0	R
5	SYNC_LOCKED		SYNC_LOCKED is set to 1 when sync is locked.	0	R
4	SYNC_DONE		SYNC_DONE is set to 1 when sync is done.	0	R
3	PLL_LOST		PLL_LOST is set to 1 when PLL loses lock.	0	R
2	PLL_LOCKED		PLL_LOCKED is set to 1 when PLL is locked.	0	R

INTERRUPT FLAG 1 REGISTER

Address: 0x06, Reset: 0x00, Name: INTERRUPT_FLAG1

Table 27. Bit Descriptions for INTERRUPT_FLAG1

Bit No.	Bit Name	Settings	Description	Reset	Access
7	PARITY_FAIL		PARITY_FAIL is set to 1 when the parity check fails.	0	R
6	SED_FAIL		SED_FAIL is set to 1 when the SED comparison fails.	0	R
5	DLL_WARNING		DLL_WARNING is set to 1 when the DLL raises a warning.	0	R
4	DLL_LOCKED		DLL_LOCKED is set to 1 when the DLL is locked.	0	R
2	FIFO_UNDERFLOW		FIFO_UNDERFLOW is set to 1 when the FIFO read pointer catches the FIFO write pointer.	0	R
1	FIFO_OVERFLOW		FIFO_OVERFLOW is set to 1 when the FIFO write pointer catches the FIFO read pointer.	0	R

INTERRUPT SELECT 0 REGISTER

Address: 0x07, Reset: 0x00, Name: IRQ_SEL0

Table 28. Bit Descriptions for IRQ_SEL0

Bit No.	Bit Name	Settings	Description	Reset	Access
6	SEL_SYNC_LOST	0	Selects the $\overline{\text{IRQ1}}$ pin.	0	R/W
		1	Selects the $\overline{\text{IRQ2}}$ pin.		
5	SEL_SYNC_LOCKED	0	Selects the $\overline{\text{IRQ1}}$ pin.	0	R/W
		1	Selects the $\overline{\text{IRQ2}}$ pin.		
4	SEL_SYNC_DONE	0	Selects the $\overline{\text{IRQ1}}$ pin.	0	R/W
		1	Selects the $\overline{\text{IRQ2}}$ pin.		
3	SEL_PLL_LOST	0	Selects the $\overline{\text{IRQ1}}$ pin.	0	R/W
		1	Selects the $\overline{\text{IRQ2}}$ pin.		
2	SEL_PLL_LOCKED	0	Selects the $\overline{\text{IRQ1}}$ pin.	0	R/W
		1	Selects the $\overline{\text{IRQ2}}$ pin.		

INTERRUPT SELECT 1 REGISTER

Address: 0x08, Reset: 0x00, Name: IRQ_SEL1

Table 29. Bit Descriptions for IRQ_SEL1

Bit No.	Bit Name	Settings	Description	Reset	Access
7	SEL_PARITY_FAIL	1	Selects the $\overline{\text{IRQ2}}$ pin.	0	R/W
		0	Selects the $\overline{\text{IRQ1}}$ pin.		
6	SEL_SED_FAIL	1	Selects the $\overline{\text{IRQ2}}$ pin.	0	R/W
		0	Selects the $\overline{\text{IRQ1}}$ pin.		
5	SEL_DLL_WARNING	0	Selects the $\overline{\text{IRQ1}}$ pin.	0	R/W
4	SEL_DLL_LOCKED	1	Selects the $\overline{\text{IRQ2}}$ pin.	0	R/W
		0	Selects the $\overline{\text{IRQ1}}$ pin.		
2	SEL_FIFO_UNDERFLOW	1	Selects the $\overline{\text{IRQ2}}$ pin.	0	R/W
		0	Selects the $\overline{\text{IRQ1}}$ pin.		
1	SEL_FIFO_OVERFLOW	1	Selects the $\overline{\text{IRQ2}}$ pin.	0	R/W
		0	Selects the $\overline{\text{IRQ1}}$ pin.		

FRAME MODE REGISTER

Address: 0x09, Reset: 0x00, Name: FRAME_MODE

Table 30. Bit Descriptions for FRAME_MODE

Bit No.	Bit Name	Description	Reset	Access
5	PARUSAGE	Must be set to 1 when parity is used	0	R/W
4	FRMUSAGE	Must be set to 1 when frame is used.	0	R/W
[1:0]	FRAME_PIN_USAGE	0 = no effect. 1 = parity. 2 = frame. 3 = reserved.	0x0	R/W

DATA CONTROL 0 REGISTER

Address: 0x0A, Reset: 0x40, Name: DATA_CNTR_0

Table 31. Bit Descriptions for DATA_CNTR_0

Bit No.	Bit Name	Description	Reset	Access
7	DLL_ENABLE	1 = enable DLL. 0 = disable DLL.	0	R/W
6	DUTY_CORRECTION_EN	1 = enable duty cycle correction. 0 = disable duty cycle correction.	1	R/W
[3:0]	DLL_PHASE_OFFSET	Locked phase = $90^\circ + n \times 11.25^\circ$, where n is the 4-bit signed magnitude number.	0x0	R/W

DATA CONTROL 1 REGISTER

Address: 0x0B, Reset: 0x39, Name: DATA_CNTR_1

Table 32. Bit Descriptions for DATA_CNTR_1

Bit No.	Bit Name	Description	Reset	Access
7	CLEAR_WARN	1: clears data receiver warning bits (Register 0x0E[6:4]).	0	R/W
[6:0]	Reserved	Must write the default value for optimal performance.	0x39	R/W

DATA CONTROL 2 REGISTER

Address: 0x0C, Reset: 0x64, Name: DATA_CNTR_2

Table 33. Bit Descriptions for DATA_CNTR_2

Bit No.	Bit Name	Description	Reset	Access
[7:0]	Reserved	Must write the default value for optimal performance.	0x64	R/W

DATA CONTROL 3 REGISTER

Address: 0x0D, Reset: 0x06, Name: DATA_CNTR_3

Table 34. Bit Descriptions for DATA_CNTR_3

Bit No.	Bit Name	Description	Reset	Access
7	LOW_DCI_EN	Set to 0 when the DLL is enabled and the DCI rate \geq 350 MHz. Set to 1 when the DLL is enabled and the DCI rate <350 MHz.	0	R/W
4	DC_COUPLE_LOW_EN	Set to 0 when the DLL is enabled and the delay line is disabled. Set to 1 when the DLL is disabled and the delay line is enabled. It is recommended that DLL mode be used for DCI rates faster than 250 MHz and delay line mode be used for DCI rates slower than 250 MHz.	0	R/W
[3:0]	Reserved	Must write the default value for optimal performance.	0x6	R/W

DATA STATUS 0 REGISTER

Address: 0x0E, Reset: 0x00, Name: DATA_STAT_0

Table 35. Bit Descriptions for DATA_STAT_0

Bit No.	Bit Name	Description	Reset	Access
7	DLL_LOCK	1 = DLL lock.	0	R
6	DLL_WARN	1 = DLL near the beginning/end of the delay line.	0	R
5	DLL_START_WARNING	1 = DLL at the beginning of the delay line.	0	R
4	DLL_END_WARNING	1 = DLL at the end of the delay line.	0	R
3	Reserved	Reserved.	0	R
2	DCI_ON	1 = user has provided a DCI clock.	0	R
1	Reserved	Reserved.	0	R
0	DLL_RUNNING	1 = closed-loop DLL attempting to lock. 0 = delay fixed at middle of the delay line.	0	R

DAC CLOCK RECEIVER CONTROL REGISTER

Address: 0x10, Reset: 0xFF, Name: DACCLK_RECEIVER_CTRL

Table 36. Bit Descriptions for DACCLK_RECEIVER_CTRL

Bit No.	Bit Name	Settings	Description	Reset	Access
7	DACCLK_DUTYCYCLE_CORRECTION		Enables duty cycle correction at the DACCLK input. For best performance, the default and recommended status is turned on.	1	R/W
6	Reserved		Must write the default value for optimal performance	1	R/W
5	DACCLK_CROSSPOINT_CTRL_ENABLE		Enables crosspoint control at the DACCLK input. For best performance, the default and recommended status is turned on.	1	R/W
[4:0]	DACCLK_CROSSPOINT_LEVEL	01111 11111	A twos complement value. For best performance, set the DACCLK_CROSSPOINT_LEVEL to the default value. Highest crosspoint. Lowest crosspoint.	0x1F	R/W

REFERENCE CLOCK RECEIVER CONTROL REGISTER

Address: 0x11, Reset: 0x5F, Name: REFCLK_RECEIVER_CTRL

Table 37. Bit Descriptions for REFCLK_RECEIVER_CTRL

Bit No.	Bit Name	Settings	Description	Reset	Access
7	DUTYCYCLE_CORRECTION		Enables duty cycle correction at the REFCLK input. For best performance, the default and recommended status is turned off.	0	RW
6	Reserved		Must write the default value for optimal performance.	1	R/W
5	REFCLK_CROSSPOINT_CTRL_ENABLE		Enables crosspoint control at the REFCLK input. For best performance, the default and recommended status is turned off.	0	RW
[4:0]	REFCLK_CROSSPOINT_LEVEL	01111 11111	A twos complement value. For best performance, set REFCLK_CROSSPOINT_LEVEL to the default value. Highest crosspoint. Lowest crosspoint.	0x1F	RW

PLL CONTROL 0 REGISTER

Address: 0x12, Reset: 0x00, Name: PLL_CTRL0

Table 38. Bit Descriptions for PLL_CTRL0

Bit No.	Bit Name	Settings	Description	Reset	Access
7	PLL_ENABLE		Enables PLL clock multiplier.	0	R/W
6	AUTO_MANUAL_SEL	0 1	PLL band selection mode. Automatic mode. Manual mode.	0	R/W
[5:0]	PLL_MANUAL_BAND	000000 111111	PLL band setting in manual mode. 64 bands in total, covering a 1 GHz to 2.1 GHz VCO range. Lowest band (1.03 GHz). Highest band (2.07 GHz).	0x00	R/W

PLL CONTROL 2 REGISTER

Address: 0x14, Reset: 0xE7, Name: PLL_CTRL2

Table 39. Bit Descriptions for PLL_CTRL2

Bit No.	Bit Name	Settings	Description	Reset	Access
[7:5]	PLL_LOOP_BW	0x00 0x1F	Selects the PLL loop filter bandwidth. The default and recommended setting is 111 for optimal PLL performance. Lowest setting. Highest setting.	0x7	R/W
[4:0]	PLL_CP_CURRENT	0x00 0x1F	Sets nominal PLL charge pump current. The default and recommended setting is 00111 for optimal PLL performance. Lowest setting. Highest setting.	0x07	R/W

PLL CONTROL 3 REGISTER

Address: 0x15, Reset: 0xC9, Name: PLL_CTRL3

Table 40. Bit Descriptions for PLL_CTRL3

Bit No.	Bit Name	Settings	Description	Reset	Access
[7:6]	DIGLOGIC_DIVIDER	00 01 10 11	REFCLKx to PLL digital clock divide ratio. The PLL digital clock drives the internal PLL logics. The divide ratio must be set to ensure that the PLL digital clock is below 75 MHz. $f_{REFCLK}/f_{DIG} = 2.$ $f_{REFCLK}/f_{DIG} = 4.$ $f_{REFCLK}/f_{DIG} = 8.$ $f_{REFCLK}/f_{DIG} = 16.$	0x3	R/W
4	CROSSPOINT_CTRL_EN		Enable loop divider crosspoint control. The default and recommended setting is set to 0 for optimal PLL performance.	0	R/W
[3:2]	VCO_DIVIDER	00 01 10 11	PLL VCO divider. This divider determines the ratio of the VCO frequency to the DACCLK frequency. $f_{VCO}/f_{DACCLK} = 1.$ $f_{VCO}/f_{DACCLK} = 2.$ $f_{VCO}/f_{DACCLK} = 4.$ $f_{VCO}/f_{DACCLK} = 4.$	0x2	R/W
[1:0]	LOOP_DIVIDER	00 01 10 11	PLL loop divider. This divider determines the ratio of the DACCLK frequency to the REFCLK frequency. $f_{DACCLK}/f_{REFCLK} = 2.$ $f_{DACCLK}/f_{REFCLK} = 4.$ $f_{DACCLK}/f_{REFCLK} = 8.$ $f_{DACCLK}/f_{REFCLK} = 16.$	0x1	R/W

PLL STATUS 0 REGISTER

Address: 0x16, Reset: 0x00, Name: PLL_STATUS0

Table 41. Bit Descriptions for PLL_STATUS0

Bit No.	Bit Name	Settings	Description	Reset	Access
7	PLL_LOCK		PLL clock multiplier output is stable.	0	R
[3:0]	VCO_CTRL_VOLTAGE_READBACK	1111 0111 0000	VCO control voltage readback. A binary value. The highest VCO control voltage. The midvalue when a proper VCO band is selected. When the PLL is locked, selecting a higher VCO band decreases this value and selecting a lower VCO band increases this value. The lowest VCO control voltage.	0x0	R

PLL STATUS 1 REGISTER

Address: 0x17, Reset: 0x00, Name: PLL_STATUS1

Table 42. Bit Descriptions for PLL_STATUS1

Bit No.	Bit Name	Settings	Description	Reset	Access
[5:0]	PLL_BAND_READBACK		Indicates the VCO band that is currently selected.	0x00	R

DAC FS ADJUST LSB REGISTER

Address: 0x18, Reset: 0xF9, Name: DAC_FS_ADJ0

Table 43. Bit Descriptions for DAC_FS_ADJ0

Bit No.	Bit Name	Settings	Description	Reset	Access
[7:0]	DAC_FULLSCALE_ADJUST_LSB		See Register 0x19.	0xF9	R/W

DAC FS ADJUST MSB REGISTER

Address: 0x19, Reset: 0xE1, Name: DAC_FS_ADJ1

Table 44. Bit Descriptions for DAC_FS_ADJ1

Bit No.	Bit Name	Settings	Description	Reset	Access
[7:5]	BG_TRIM		Bandgap trim code. Set to the default value for optimal performance.	0x7	R/W
[1:0]	DAC_FULLSCALE_ADJUST_MSB		DAC full-scale adjust, Bits[9:0] sets the full-scale current of the DAC. The full-scale current can be adjusted from 8.64 mA to 31.68 mA. The default value (0x1F9) sets the full-scale current to 20 mA.	0x1	R/W

DIE TEMPERATURE SENSOR CONTROL REGISTER

Address: 0x1C, Reset: 0x02, Name: DIE_TEMP_SENSOR_CTRL

Table 45. Bit Descriptions for DIE_TEMP_SENSOR_CTRL

Bit No.	Bit Name	Settings	Description	Reset	Access
[6:4]	FS_CURRENT		Temperature sensor ADC full-scale current. Using the default setting is recommended.	0x0	R/W
		000	50 μ A.		
		001	62.5 μ A.		
			
		110	125 μ A.		
		111	137.5 μ A.		
[3:1]	REF_CURRENT		Temperature sensor ADC reference current. Using the default setting is recommended.	0x1	R/W
		000	12.5 μ A.		
		001	19 μ A.		
			
		110	50 μ A.		
		111	56.5 μ A.		
0	DIE_TEMP_SENSOR_EN		Enable the on-chip temperature sensor.	0x0	R/W

DIE TEMPERATURE LSB REGISTER

Address: 0x1D, Reset: 0x00, Name: DIE_TEMP_LSB

Table 46. Bit Descriptions for DIE_TEMP_LSB

Bit No.	Bit Name	Settings	Description	Reset	Access
[7:0]	DIE_TEMP_LSB		This register is used together with Register 0x1E.	0x00	R

DIE TEMPERATURE MSB REGISTER

Address: 0x1E, Reset: 0x00, Name: DIE_TEMP_MSB

Table 47. Bit Descriptions for DIE_TEMP_MSB

Bit No.	Bit Name	Settings	Description	Reset	Access
[7:0]	DIE_TEMP_MSB		Die temperature, Bits[15:0] indicate the approximate die temperature. For more information, see the Temperature Sensor section.	0x00	R

CHIP ID REGISTER

Address: 0x1F, Reset: 0x0A, Name: CHIP_ID

Table 48. Bit Descriptions for CHIP_ID

Bit No.	Bit Name	Settings	Description	Reset	Access
[7:0]	CHIP_ID		The AD9139 chip ID is 0x0A.	0x0A	R

INTERRUPT CONFIGURATION REGISTER

Address: 0x20, Reset: 0x00, Name: INTERRUPT_CONFIG

Table 49. Bit Descriptions for INTERRUPT_CONFIG

Bit No.	Bit Name	Settings	Description	Reset	Access
[7:0]	INTERRUPT_CONFIGURATION	0x00 0x01	Test mode. Recommended mode (described in the Interrupt Request Operation section).	0x00	R/W

SYNC CONTROL REGISTER

Address: 0x21, Reset: 0x00, Name: SYNC_CTRL

Table 50. Bit Descriptions for SYNC_CTRL

Bit No.	Bit Name	Settings	Description	Reset	Access
1	SYNC_CLK_EDGE_SEL	0 1	Selects the sampling edge of the DACCLK on the sync clock. SYNC CLK is sampled by rising edges of DACCLK. SYNC CLK is sampled by falling edges of DACCLK.	0	R/W
0	SYNC_ENABLE		Enables multichip synchronization.	0	R/W

FRAME RESET CONTROL REGISTER

Address: 0x22, Reset: 0x12, Name: FRAME_RST_CTRL

Table 51. Bit Descriptions for FRAME_RST_CTRL

Bit No.	Bit Name	Settings	Description	Reset	Access
3	ARM_FRAME		This bit is used to retrigger a frame reset in one shot mode (when Bit 2 is set to 0). Setting this bit to 1 requests that the device respond to the next valid frame pulse.	0	R/W
2	EN_CON_FRAME_RESET	0 1	Frame reset mode selection. Responds to the first valid frame pulse and resets the FIFO one time only. This is the default and recommended mode. Responds to every valid frame pulse and resets the FIFO continuously.	0	R/W
[1:0]	FRAME_RESET_MODE	10 11	These bits determine what is to be reset when the device receives a valid frame signal. FIFO. None.	0x2	R/W

FIFO LEVEL CONFIGURATION REGISTER

Address: 0x23, Reset: 0x40, Name: FIFO_LEVEL_CONFIG

Table 52. Bit Descriptions for FIFO_LEVEL_CONFIG

Bit No.	Bit Name	Settings	Description	Reset	Access
[6:4]	INTEGER_FIFO_LEVEL_REQUEST	000 001 ... 111	Set the integer FIFO level. This is the difference between the read pointer and the write pointer values in the unit of input data rate (f_{DATA}). The default and recommended FIFO level is integer level = 4 and fractional level = 0. See the FIFO Operation section for details.	0x4	R/W
[2:0]	FRACTIONAL_FIFO_LEVEL_REQUEST	000 001	Set the fractional FIFO level. This is the difference between the read pointer and the write pointer values in the unit of DACCLK rate (F_{DAC}). The maximum allowed setting value = interpolation rate – 1. See the FIFO Operation section for details.	0x0	R/W

FIFO LEVEL READBACK REGISTER

Address: 0x24, Reset: 0x00, Name: FIFO_LEVEL_READBACK

Table 53. Bit Descriptions for FIFO_LEVEL_READBACK

Bit No.	Bit Name	Settings	Description	Reset	Access
[6:4]	INTEGER_FIFO_LEVEL_READBACK		The integer FIFO level read back. The difference between the overall FIFO level request and readback is within two DACCLK cycles. See the FIFO Operation section for details.	0x0	R
[2:0]	FRACTIONAL_FIFO_LEVEL_READBACK		The fractional FIFO level read back. This value is used in combination with the readback in Bit[6:4].	0x0	R

FIFO CONTROL REGISTER

Address: 0x25, Reset: 0x00, Name: FIFO_CTRL

Table 54. Bit Descriptions for FIFO_CTRL

Bit No.	Bit Name	Settings	Description	Reset	Access
1	FIFO_SPI_RESET_ACK		Acknowledge a serial port initialized FIFO reset.	0x0	R
0	FIFO_SPI_RESET_REQUEST		Initialize a FIFO reset via the serial port.	0x0	R/W

DATA FORMAT SELECT REGISTER

Address: 0x26, Reset: 0x00, Name: DATA_FORMAT_SEL

Table 55. Bit Descriptions for DATA_FORMAT_SEL

Bit No.	Bit Name	Settings	Description	Reset	Access
7	DATA_FORMAT		Select binary or twos complement data format.	0	R/W
		0	Input data in twos complement format.		
		1	Input data in binary format.		
0	DATA_BUS_WIDTH		Data interface mode. See the LVDS Input Data Ports section for information about the operation of the different interface modes.	0	R/W
		0	Word mode; 16-bit interface bus width.		
		1	Byte mode; 8-bit interface bus width.		

DATAPATH CONTROL REGISTER

Address: 0x27, Reset: 0x00, Name: DATAPATH_CTRL

Table 56. Bit Descriptions for DATAPATH_CTRL

Bit No.	Bit Name	Settings	Description	Reset	Access
7	INVSINC_ENABLE		Enable the inverse sinc filter.	0	RW
5	DIG_GAIN_DCOFFSET_ENABLE		Enable digital gain adjustment and dc offset.	0	RW

INTERPOLATION CONTROL REGISTER

Address: 0x28, Reset: 0x00, Name: INTERPOLATION_CTRL

Table 57. Bit Descriptions for INTERPOLATION_CTRL

Bit No.	Bit Name	Settings	Description	Reset	Access
7	INTERPOLATION_MODE		Interpolation mode selection.	0x0	RW
		0	2× mode.		
		1	1× mode.		

POWER-DOWN DATA INPUT 0 REGISTER

Address: 0x39, Reset: 0x00, Name: LVDS_IN_PWR_DOWN_0

Table 58. Bit Descriptions for LVDS_IN_PWR_DOWN_0

Bit No.	Bit Name	Settings	Description	Reset	Access
[3:0]	PWR_DOWN_DATA_INPUT_BITS		Powers down Data Input Bits[3:0]. Each bit controls one data input bit. These bits can be powered down individually.	0x0	R/W

DAC DC OFFSET 0 REGISTER

Address: 0x3B, Reset: 0x00, Name: DAC_DC_OFFSET0

Table 59. Bit Descriptions for DAC_DC_OFFSET0

Bit No.	Bit Name	Settings	Description	Reset	Access
[7:0]	DAC_DC_OFFSET_LSB		See Register 0x3C.	0x00	RW

DAC DC OFFSET 1 REGISTER

Address: 0x3C, Reset: 0x00, Name: DAC_DC_OFFSET1

Table 60. Bit Descriptions for DAC_DC_OFFSET1

Bit No.	Bit Name	Settings	Description	Reset	Access
[7:0]	DAC_DC_OFFSET_MSB		DAC DC offset, Bits[15:0], is a dc value that is added directly to the sample values written to the DAC.	0x00	RW

DAC GAIN ADJ REGISTER

Address: 0x3F, Reset: 0x20, Name: DAC_DIG_GAIN

Table 61. Bit Descriptions for DAC_GAIN_ADJ

Bit No.	Bit Name	Settings	Description	Reset	Access
[5:0]	DAC_DIG_GAIN		This register is the 6-bit digital gain adjust. The bit weighting is MSB = 2^0 , LSB = 2^{-5} , which yields a multiplier range of 0 to 2 or $-\infty$ to 6 dB. The default gain setting is 0x20, which maps to unity gain (0 dB).	0x20	RW

GAIN STEP CONTROL 0 REGISTER

Address: 0x41, Reset: 0x01, Name: GAIN_STEP_CTRL0

Table 62. Bit Descriptions for GAIN_STEP_CTRL0

Bit No.	Bit Name	Settings	Description	Reset	Access
[5:0]	RAMP_UP_STEP		This register sets the step size of the increasing gain. The digital gain increases by the configured amount in every four DAC cycles until the gain reaches the setting in DAC_GAIN_ADJ (Register 0x3F). The bit weighting is MSB = 2^1 , LSB = 2^{-4} . Note that the value in this register must not be greater than the values in the DAC_GAIN_ADJ.	0x01	RW

GAIN STEP CONTROL 1 REGISTER

Address: 0x42, Reset: 0x01, Name: GAIN_STEP_CTRL1

Table 63. Bit Descriptions for GAIN_STEP_CTRL1

Bit No.	Bit Name	Settings	Description	Reset	Access
7	DAC_OUTPUT_STATUS		This bit indicates the DAC output on/off status. When the DAC output is automatically turned off, this bit is 1.	0x0	RW
6	DAC_OUTPUT_ON		In the case where the DAC output is automatically turned off in the Tx enable mode, this register allows for turning on the DAC output manually. It is a self clear bit.	0x0	R
[5:0]	RAMP_DOWN_STEP		This register sets the step size of the decreasing gain. The digital gain decreases by the configured amount in every four DAC cycles until the gain reaches zero. The bit weighting is MSB = 2^1 , LSB = 2^{-4} . Note that the value in this register must not be greater than the values in the DAC_GAIN_ADJ (Register 0x3F).	0x01	RW

TX ENABLE CONTROL REGISTER

Address: 0x43, Reset: 0x07, Name: TX_ENABLE_CTRL

Table 64. Bit Descriptions for TX_ENABLE_CTRL

Bit No.	Bit Name	Settings	Description	Reset	Access
2	TXENABLE_GAINSTEP_EN		DAC output gradually turns on/off under the control of the TXENABLE signal from the TXEN pin according to the settings in Register 0x41 and Register 0x42.	1	RW
1	TXENABLE_SLEEP_EN		When set to 1, the device enters sleep mode when the TXENABLE signal from the TXEN pin is low.	1	RW
0	TXENABLE_POWER_DOWN_EN		When set to 1, the device enters power-down mode when the TXENABLE signal from the TXEN pin is low.	1	RW

DAC OUTPUT CONTROL REGISTER

Address: 0x44, Reset: 0x8F, Name: DAC_OUTPUT_CTRL

Table 65. Bit Descriptions for DAC_OUTPUT_CTRL

Bit No.	Bit Name	Settings	Description	Reset	Access
7	DAC_OUTPUT_CTRL_EN		Enable the DAC output control. This bit needs to be set to 1 to enable the rest of the bits in this register.	0x1	RW
3	FIFO_WARNING_SHUTDOWN_EN		When this bit and Bit 7 are both high, if a FIFO warning occurs, the DAC output shuts down automatically. By default, this function is on.	0x1	RW
0	FIFO_ERROR_SHUTDOWN_EN		The DAC output is turned off when the FIFO reports warnings.	0x1	RW

DLL CELL ENABLE 0 REGISTER

Address: 0x5E, Reset: 0xFF, Name: ENABLE_DLL_DELAY_CELL0

Table 66. Bit Descriptions for ENABLE_DLL_DELAY_CELL0

Bit No.	Bit Name	Description	Reset	Access
[7:0]	DELAY_CELL_ENABLE [7:0]	Set each bit to enable or disable the delay cell. Delay cell number corresponds to bit number. 1 = enable delay cell (default). 0 = disable delay cell. Different recommended values should be used in DLL mode and delay line mode. See the DLL Interface Mode section.	0xFF	RW

DLL CELL ENABLE 1 REGISTER

Address: 0x5F, Reset: 0x67, Name: ENABLE_DLL_DELAY_CELL1

Table 67. Bit Descriptions for ENABLE_DLL_DELAY_CELL1

Bit No.	Bit Name	Description	Reset	Access
[7:3]	Reserved	Must write the default value for optimal performance.	0x0C	RW
[2:0]	DELAY_CELL_ENABLE [10:8]	Set each bit to enable or disable the delay cell. Delay cell numbers are (10, 9, 8) corresponding to bits (2, 1, 0). 1 = enable delay cell (default). 0 = disable delay cell.	0x7	RW

SED CONTROL REGISTER

Address: 0x60, Reset: 0x00, Name: SED_CTRL

Table 68. Bit Descriptions for SED_CTRL

Bit No.	Bit Name	Description	Reset	Access
7	SED_ENABLE	Set to 1 to enable the SED compare logic.	0	RW
6	SED_ERR_CLEAR	When 1, clears all SED reported error bits, Bit 2, Bit 1, and Bit 0.	0	RW
5	AED_ENABLE	When 1, enables the AED function (SED with autoclear after eight passing sets).	0	RW
4	SED_DEPTH	0 = SED depth of two words, 1 = SED depth of four words.	0	RW
3	Reserved	Reserved.	0	R
2	AED_PASS	When AED = 1, it signals eight true compare cycles.	0	RW
1	AED_FAIL	When AED = 1, it signals a mismatch in comparison.	0	R
0	SED_FAIL	Signals that an SED mismatch in comparison occurred (with SED or AED enabled).	0	R

SED PATTERN S0 LOW BITS REGISTER

Address: 0x61, Reset: 0x00, Name: SED_PATT_L_S0

Table 69. Bit Descriptions for SED_PATT_L_S0

Bit No.	Bit Name	Description	Reset	Access
[7:0]	SED_PATTERN_RISE_S0 [7:0]	SED S0 rising edge low bits.	0x00	RW

SED PATTERN S0 HIGH BITS REGISTER

Address: 0x62, Reset: 0x00, Name: SED_PATT_H_S0

Table 70. Bit Descriptions for SED_PATT_H_S0

Bit No.	Bit Name	Description	Reset	Access
[7:0]	SED_PATTERN_RISE_S0 [15:8]	SED S0 rising edge high bits.	0x00	RW

SED PATTERN S1 LOW BITS REGISTER

Address: 0x63, Reset: 0x00, Name: SED_PATT_L_S1

Table 71. Bit Descriptions for SED_PATT_L_S1

Bit No.	Bit Name	Description	Reset	Access
[7:0]	SED_PATTERN_FALL_S1 [7:0]	SED S1 falling edge low bits.	0x00	RW

SED PATTERN S1 HIGH BITS REGISTER

Address: 0x64, Reset: 0x00, Name: SED_PATT_H_S1

Table 72. Bit Descriptions for SED_PATT_H_S1

Bit No.	Bit Name	Description	Reset	Access
[7:0]	SED_PATTERN_FALL_S1 [15:8]	SED S1 falling edge high bits.	0x00	RW

SED PATTERN S2 LOW BITS REGISTER

Address: 0x65, Reset: 0x00, Name: SED_PATT_L_S2

Table 73. Bit Descriptions for SED_PATT_L_S2

Bit No.	Bit Name	Description	Reset	Access
[7:0]	SED_PATTERN_RISE_S2 [7:0]	SED S2 rising edge low bits.	0x00	RW

SED PATTERN S2 HIGH BITS REGISTER

Address: 0x66, Reset: 0x00, Name: SED_PATT_H_S2

Table 74. Bit Descriptions for SED_PATT_H_S2

Bit No.	Bit Name	Description	Reset	Access
[2:0]	SED_PATTERN_RISE_S2 [15:8]	SED S2 rising edge high bits.	0x00	RW

SED PATTERN S3 LOW BITS REGISTER

Address: 0x67, Reset: 0x00, Name: SED_PATT_L_S3

Table 75. Bit Descriptions for SED_PATT_L_S3

Bit No.	Bit Name	Description	Reset	Access
[7:0]	SED_PATTERN_FALL_S3 [7:0]	SED s3 falling edge low bits.	0x00	RW

SED PATTERN S3 HIGH BITS REGISTER

Address: 0x68, Reset: 0x00, Name: SED_PATT_H_S3

Table 76. Bit Descriptions for SED_PATT_H_S3

Bit No.	Bit Name	Description	Reset	Access
[2:0]	SED_PATTERN_FALL_S3 [15:8]	SED S3 falling edge high bits.	0x00	RW

PARITY CONTROL REGISTER

Address: 0x6A, Reset: 0x00, Name: PARITY_CTRL

Table 77. Bit Descriptions for PARITY_CTRL

Bit No.	Bit Name	Settings	Description	Reset	Access
7	PARITY_ENABLE	1	Enable parity.	0	RW
6	PARITY_EVEN	0 1	Odd parity. Even parity.	0	RW
5	PARITY_ERR_CLEAR		Set to 1 to clear parity error counters.	0	RW
[4:2]	Reserved		Reserved.	0x0	R
1	PARERRFAL		When 1, signals a falling edge parity error was detected.	0	R
0	PARERRRIS		When 1, signals a rising edge parity error was detected.	0	R

PARITY ERROR RISING EDGE REGISTER

Address: 0x6B, Reset: 0x00, Name: PARITY_ERR_RISING

Table 78. Bit Descriptions for PARITY_ERR_RISING

Bit No.	Bit Name	Description	Reset	Access
[7:0]	PARITY RISING EDGE ERROR COUNT	Number of rising edge-based errors detected (S0 and S2). Clipped to 256.	0x00	R

PARITY ERROR FALLING EDGE REGISTER

Address: 0x6C, Reset: 0x00, Name: PARITY_ERR_FALLING

Table 79. Bit Descriptions for PARITY_ERR_FALLING

Bit No.	Bit Name	Description	Reset	Access
[7:0]	PARITY FALLING EDGE ERROR COUNT	Number of falling edge-based errors detected (S1 and S3). Clipped to 256.	0x00	R

VERSION REGISTER

Address: 0x7F, Reset: 0x07, Name: Version

Table 80. Bit Descriptions for Version

Bit No.	Bit Name	Settings	Description	Reset	Access
[7:0]	Version		Chip version	0x07	R

PACKAGING AND ORDERING INFORMATION

OUTLINE DIMENSIONS

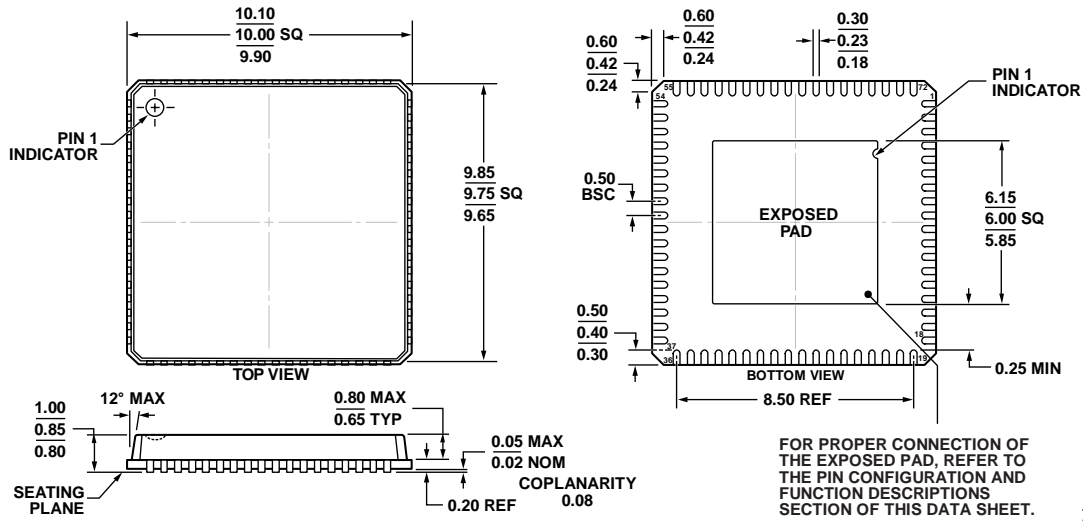

COMPLIANT TO JEDEC STANDARDS MO-220-VNND-4

Figure 51. 72-Lead Lead Frame Chip Scale Package [LFCSP_VQ]
 10 mm × 10 mm Body, Very Thin Quad
 (CP-72-7)
 Dimensions shown in millimeters

06-25-2012-A

ORDERING GUIDE

Model ¹	Temperature Range	Package Description	Package Option
AD9139BCPZ	-40°C to +85°C	72-lead LFCSP_VQ	CP-72-7
AD9139BCPZRL	-40°C to +85°C	72-lead LFCSP_VQ	CP-72-7
AD9139-EBZ		Evaluation Board for Single AD9139 Evaluation	
AD9139-DUAL-EBZ		Evaluation Board for Dual AD9139 Evaluation	

¹ Z = RoHS Compliant Part.