

# GaAs MMIC Control FET in SOT 143 DC-2.5 GHz



AF002C1-32

## Features

- Low Cost
- Small SOT 143 Package
- Series or Shunt Configuration
- Low DC Current Drain
- Ideal Switch Building Block

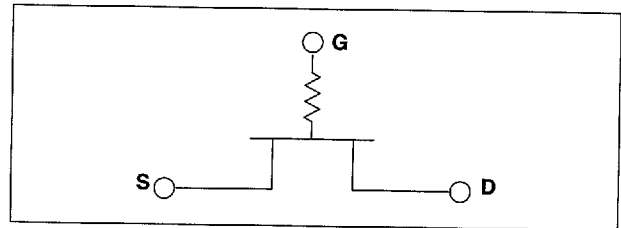
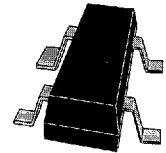

## Description

The AF002C1-32 consists of a single GaAs switching FET that can be used in both series and shunt configurations. A positive control voltage may be used by simply adding 3 DC blocking capacitors.

Isolation performance degrades at higher frequencies due to package parasitics. These parasitics can be tuned out in narrow band applications as shown in a AF002C1-39 data sheet.

## Absolute Maximum Ratings

RF Input Power:	2W > 500 MHz 0/-8V
	0.5W @ 50 MHz 0/-8V
Control Voltage:	+0.2V, -10V
Operating Temperature:	-40°C to 85°C
Storage Temperature:	-65°C to 150°C
Θ <sub>JC</sub> :	25°C/W

Note: Exceeding these parameters may cause irreversible damage.

## Operating Characteristics at 25°C

Switching Characteristics			
RISE, FALL (10/90% or 90/10% RF)	3	ns	Typ
ON, OFF (50% CTL to 90/10% RF)	6	ns	Typ
Input Power for 1 dB Compression			
Control Voltages (Vdc)	0/-5	0/-8	
0.5-2.0 GHz	+20	24	dBm Typ
Control Voltages			
V <sub>0</sub> (Low)	0 to -0.2V @ 20 μA Max		
V <sub>0</sub> (High)	-5V @ 50 μA to -9V @ 200 μA Max		

## Electrical Specifications at 25°C

R <sub>ON</sub> <sup>1</sup>	C <sub>OFF</sub> <sup>2</sup>	Insertion Loss 1 GHz <sup>3,4</sup>	
		Series	Shunt
6.4	0.13	0.7 dB	0.2

1. R<sub>ON</sub> - Resistance in ohms in low impedance state when '0' Volts is applied on Gate (G).
2. C<sub>OFF</sub> - Capacitance (FET) in pF in high impedance state when -5V is applied on Gate (G).
3. Package inductance is 3 nH, package capacitance is 0.17 pf.
4. Insertion loss changes by 0.003 dB/°C.

### Typical Performance Data

Series Configuration (Not Tuned)

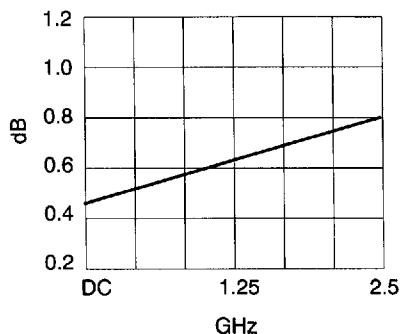

Insertion Loss vs. Frequency

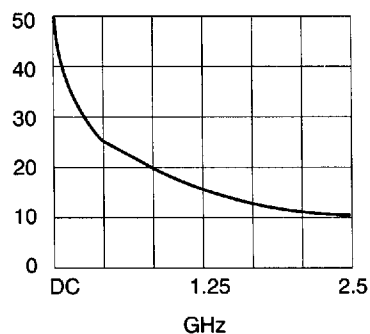

Isolation vs. Frequency

### Pin Out

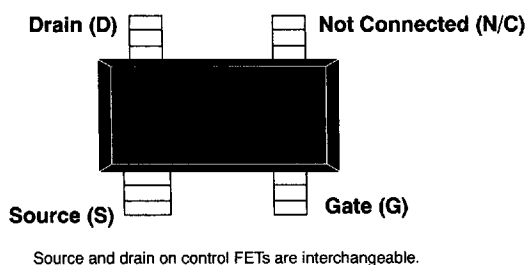

### Truth Table (Negative Voltage Operation)

Shunt			
S	D	G	State
GND	RF	-5	Insertion Loss
		0	Isolation
Series			
RF	RF	-5	Isolation
		0	Insertion Loss

### Positive Voltage Operation

#### Shunt

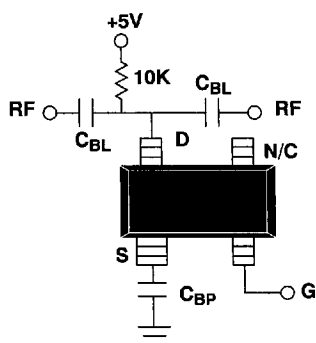

#### Series

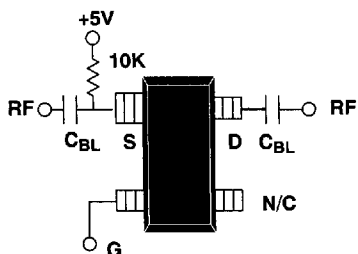

C<sub>BL</sub>, C<sub>BP</sub> - Choose value for low impedance at desired operating frequency.

### Truth Table (Positive Voltage Operation)

Shunt			
S	D	G	State
GND	RF	0	Insertion Loss
		+5	Isolation
Series			
RF	RF	0	Isolation
		+5	Insertion Loss

# RF GaAs MMIC Products in Metal Packages

## Numerical Index

Part Number	Page	Part Number	Page	Part Number	Page
AD004T2-00	2-44	AK006R2-01	2-30	AS006M1-01	2-8
AD004T2-11	2-44	AK006R2-10	2-30	AS006M1-10	2-8
AE002M2-29	2-74	AK006R2-00	2-28	AS006M2-00	2-16
AE002M4-05	2-42	AK402D4-11	2-64	AS006M2-01	2-22
AH002R2-11	2-26	AK402D4-31	2-68	AS006M2-10	2-22
AK002D2-11	2-70	AN002M2-29	2-72	AS006R1-00	2-4
AK002D4-11	2-62	AN002M4-31	2-38	AS006R2-00	2-16
AK002D4-31	2-66	AN002M4-05	2-40	AS006R2-01	2-20
AK002M4-00	2-36	AS002M4-00	2-34	AS006R2-10	2-20
AK002M4-31	2-38	AS004L1-08	2-6	AS406M2-01	2-24
AK004L1-11	2-12	AS004L1-11	2-6	AS406R2-01	2-24
AK004M1-11	2-14	AS004L2-11	2-18	AT001D3-11	2-60
AK004M2-11	2-32	AS004M1-08	2-8	AT001D4-31	2-56
AK004R2-11	2-30	AS004M1-11	2-8	AT001D6-31	2-58
AK006L1-00	2-10	AS004M2-08	2-22	AT002D8-31	2-54
AK006L1-01	2-12	AS004M2-11	2-22	AT002N5-00	2-49
AK006L1-10	2-12	AS004R2-08	2-20	AT002N5-01	2-49
AK006M1-00	2-10	AS004R2-11	2-20	AT002N5-10	2-49
AK006M1-01	2-14	AS006L1-00	2-4	AT002N5-11	2-49
AK006M1-10	2-14	AS006L1-01	2-6	AT002S3-11	2-52
AK006M2-01	2-32	AS006L1-10	2-6	AT004N3-11	2-46
AK006M2-10	2-32	AS006L2-00	2-18	AT006N3-00	2-46
AK006M2-00	2-28	AS006L2-01	2-18	AT006N3-10	2-46
AK006R1-00	2-10	AS006M1-00	2-4	AT006N3-01	2-46

0585443 0002501 710