

Low Input High Efficiency Synchronous Step-Up DC/DC Converter

FEATURES

- 1V Typical Startup Voltage
- Up to 94% Efficiency
- Fully Integrated Power Stage
- Fixed 3.3V/5V or Adjustable Output Voltage
- NanoStandby™ Shutdown Mode
- Tiny SOT23-5 Package
 - RoHS Compliant Package

APPLICATIONS

- Hand-Held Devices
- One to Three Cell Battery Operated Devices
- PDAs
- Cellular Phones
- Digital Cameras
- GPS

GENERAL DESCRIPTION

The ACT6305 is a high efficiency synchronous step-up DC/DC converter that consumes just 17µA of quiescent supply current and is capable of delivering more than 400mA output current using only three external components. This device achieves a typical startup voltage of just 1V, making it ideal for applications operating from 1 or 2 alkaline cells.

This device incorporates an internal synchronous rectifier, and achieves excellent peak efficiency of up to 94% and features a proprietary control scheme that ensures high efficiency over a wide load current range.

The ACT6305 features pin-selectable output voltages of 3.3V or 5V, or it can also be set externally to any voltage between 2V and 5V. The ACT6305 is available in a tiny SOT23-5 package.

TYPICAL APPLICATION CIRCUIT

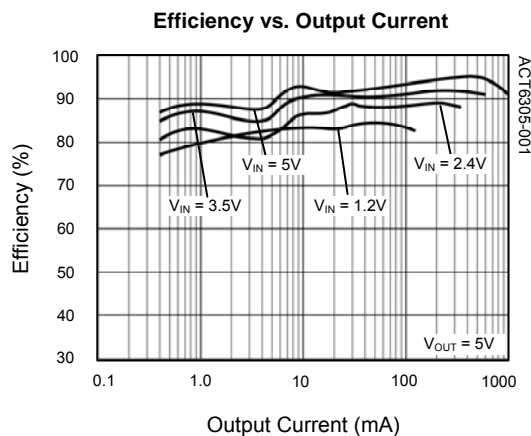
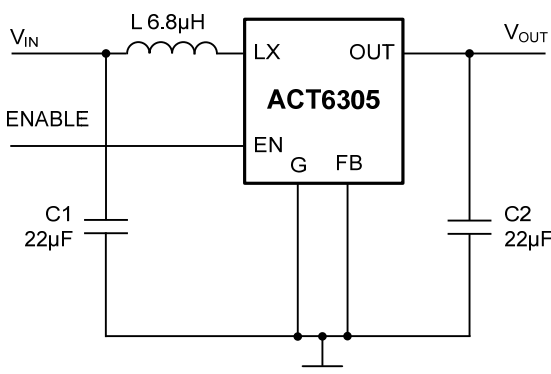

ORDERING INFORMATION

PART NUMBER	TEMPERATURE RANGE	PACKAGE	PINS	PACKING METHOD	TOP MARK
ACT6305UC-T	-40°C to 85°C	SOT23-5	5	TAPE & REEL	HBCA

All Active-Semi components are RoHS Compliant and with Pb-free plating unless specified differently. The term "Pb-free" means semiconductor products that are in compliance with current RoHS (Restriction of Hazardous Substances) standards.

PIN CONFIGURATION

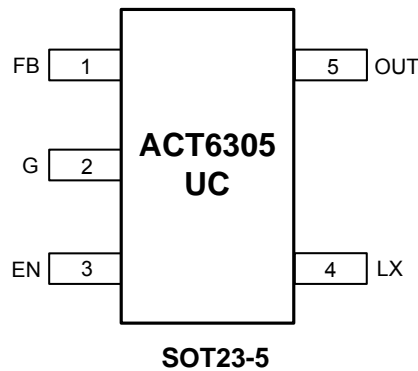

PIN DESCRIPTIONS

PIN NUMBER	PIN NAME	PIN DESCRIPTION
1	FB	Output Voltage Selection and Feedback Input. Connect this pin to G for $V_{OUT} = 5V$, to OUT for $V_{OUT} = 3.3V$. Connect FB to a resistor divider to set the output voltage between 2V and 5V. See the <i>Output Voltage Selection</i> section for more information.
2	G	Ground.
3	EN	Shutdown Input. Drive EN to OUT or to a logic high for normal operation, drive EN to G or to a logic low to disable the regulator.
4	LX	Inductor Connection.
5	OUT	Output. ACT6305 regulates voltage at this pin. OUT also provides power to the IC.

ABSOLUTE MAXIMUM RATINGS^①

PARAMETER	VALUE	UNIT
OUT, EN to G	-0.3 to 6	V
FB, LX to G	-0.3 to $V_{OUT} + 0.3$	V
Continuous LX Current	Internally Limited	A
Maximum Power Dissipation (derate 5mV/°C above $T_A = 50^\circ\text{C}$)	0.53	W
Junction to Ambient Thermal Resistance (θ_{JA})	190	°C/W
Operating Junction Temperature	-40 to 150	°C
Storage Temperature	-55 to 150	°C
Lead Temperature (Soldering, 10 sec)	300	°C

①: Do not exceed these limits to prevent damage to the device. Exposure to absolute maximum rating conditions for long periods may affect device reliability.

ELECTRICAL CHARACTERISTICS

($V_{IN} = 1.5\text{V}$, $V_{OUT} = 3.3\text{V}$, $T_A = 25^\circ\text{C}$, unless otherwise specified.)

PARAMETER	SYMBOL	TEST CONDITIONS	MIN	TYP	MAX	UNIT
Minimum Operating Input Voltage	V_{IN}			0.6		V
Maximum Operating Input Voltage	V_{IN}				5	V
Startup Voltage	V_{IN}	$I_{LOAD} = 1\text{mA}$		1	1.18	V
Output Voltage	V_{OUT}	FB = OUT; 60mV _{PP} Ripple	3.2	3.3	3.4	V
		FB = G; 40mV _{PP} Ripple	4.85	5	5.15	
Output Voltage Range		External Feedback Divider	2		5	V
Quiescent Current at OUT	I_Q	$V_{FB} = 1.3\text{V}$		17	34	μA
Shutdown Supply Current	I_{SD}	EN = G		0.1	1	μA
Startup to Normal Transition Threshold				1.85		V
FB Feedback Voltage	V_{FB}	$V_{OUT} = 2\text{V to } 5\text{V}$	1.15	1.180	1.21	V
FB Input Current		FB = 1.3V		50		nA
Power Switch Current Limit	I_{LIM}		0.7	1	1.25	A
Power Switch On Resistance	R_{ONN}	$I_{LX} = 100\text{mA}$		0.19	0.4	Ω
Synchronous Rectifier On Resistance	R_{ONP}	$I_{LX} = -100\text{mA}$		0.21	0.4	Ω
LX Leakage Current		EN = G, $V_{LX} = 0\text{V or } 3.3\text{V}$		0.1	1	μA
Maximum Switch On-Time	t_{ONMAX}		3.75	5	6.25	μs
Minimum Switch Off-Time	t_{OFFMIN}		0.75	1	1.25	μs
EN Logic Low Threshold	V_{IL}				0.3	V
EN Logic High Threshold	V_{IH}		0.6			V
EN Input Current					1	μA

TYPICAL PERFORMANCE CHARACTERISTICS

(Typical Application Circuit, L = 6.8μH, C1 = 22μF ceramic, C2 = 22μF ceramic, unless otherwise specified.)

Efficiency vs. Output Current

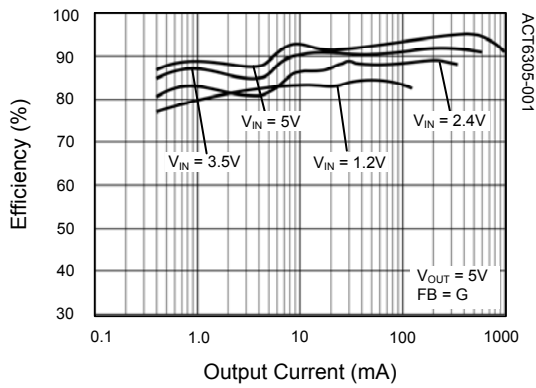

Efficiency vs. Constant Current

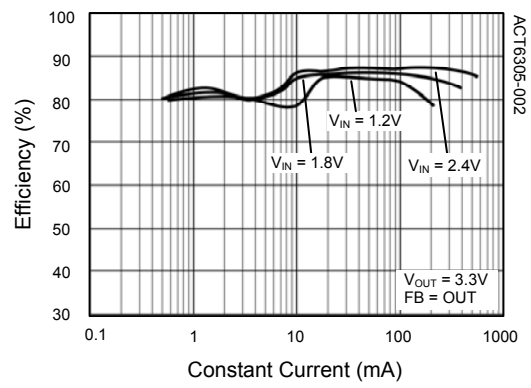

Efficiency vs. Constant Current

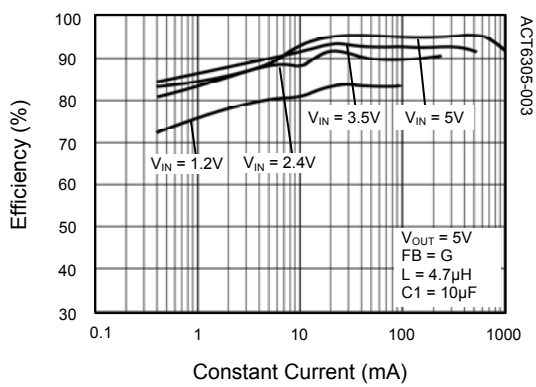

Efficiency vs. Constant Current

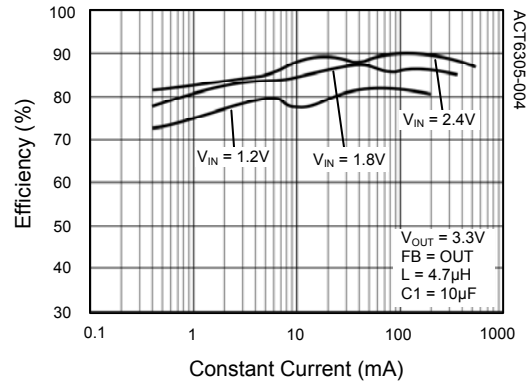

Startup Voltage vs. Constant Resistance Load

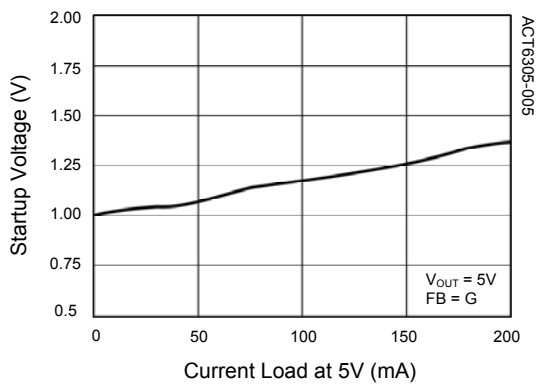

Startup Voltage vs. Constant Resistance Load

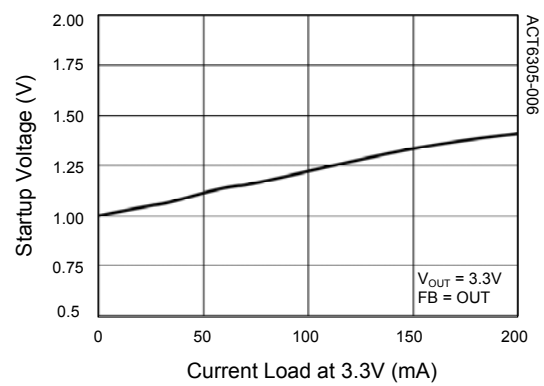

TYPICAL PERFORMANCE CHARACTERISTICS CONT'D

(Typical Application Circuit, L = 6.8 μ H, C1 = 22 μ F ceramic, C2 = 22 μ F ceramic, unless otherwise specified.)

Startup Voltage vs. Temperature

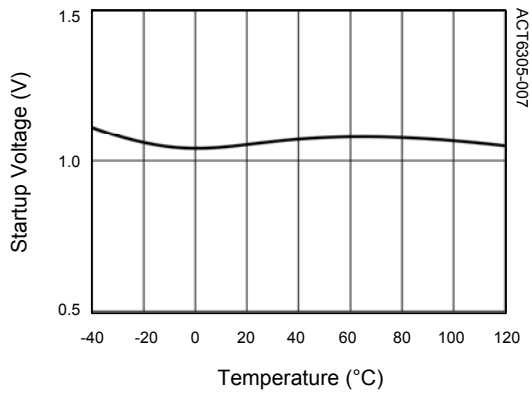

Maximum On-Time vs. Temperature

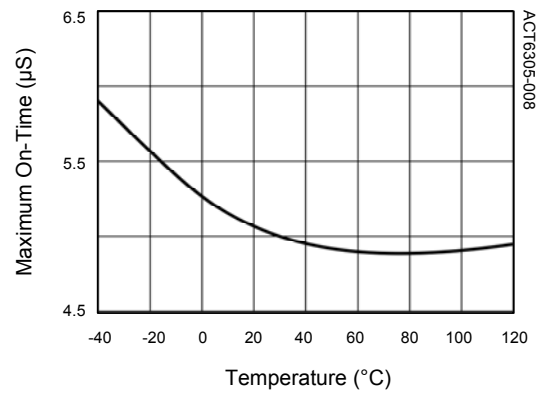

Minimum Off-Time vs. Temperature

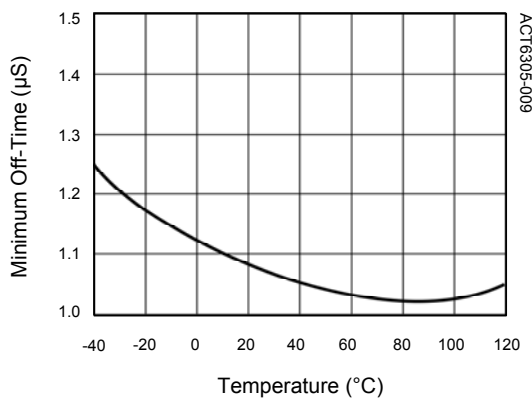

Quiescent Supply Current vs. Temperature

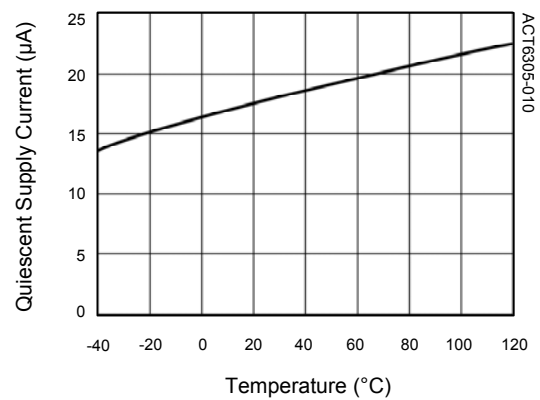

TYPICAL PERFORMANCE CHARACTERISTICS CONT'D

(Typical Application Circuit, L = 6.8μH, C1 = 22μF ceramic, C2 = 22μF ceramic, unless otherwise specified.)

Light Load Operation for Low ESR C_{OUT}

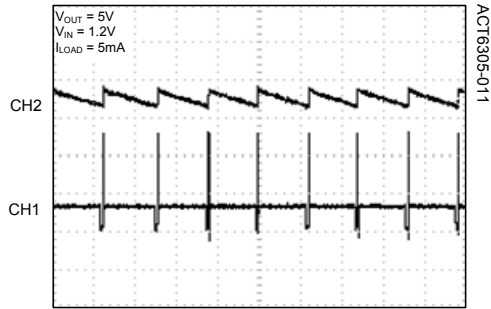

CH1: V_{LX} , 2.00V/div
 CH2: V_{OUT} , 100mV/div
 TIME: 100μs/div

Medium Load Operation for Low ESR C_{OUT}

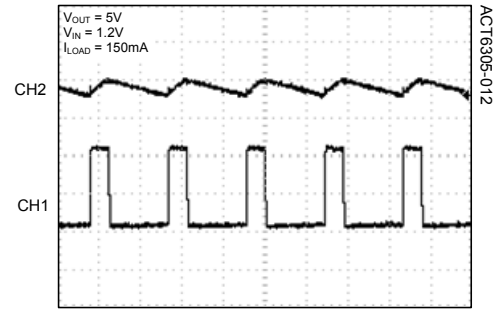

CH1: V_{LX} , 2.00V/div
 CH2: V_{OUT} , 100mV/div
 TIME: 2.50μs/div

Medium Load Operation for Low ESR C_{OUT}

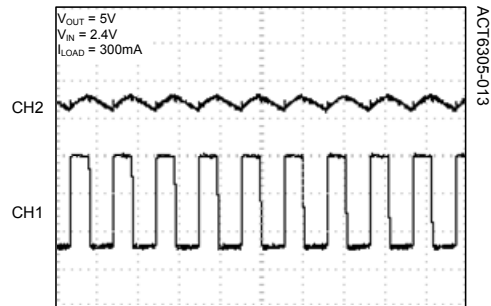

CH1: V_{LX} , 2.00V/div
 CH2: V_{OUT} , 100mV/div
 TIME: 2.50μs/div

Heavy Load Operation for Low ESR C_{OUT}

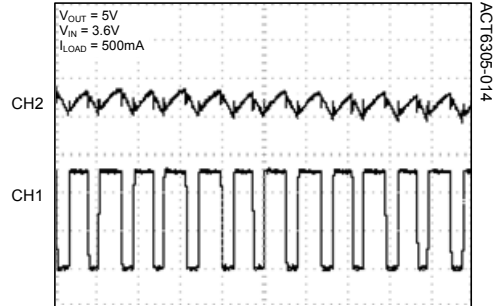

CH1: V_{LX} , 2.00V/div
 CH2: V_{OUT} , 50mV/div
 TIME: 2.50μs/div

Light Load Operation for Low ESR C_{OUT}

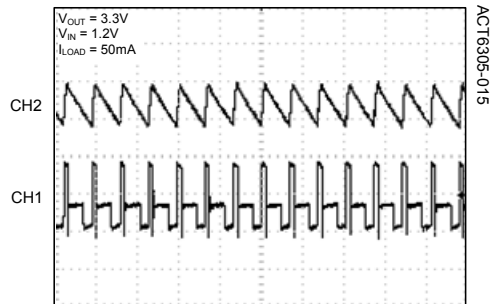

CH1: V_{LX} , 2.00V/div
 CH2: V_{OUT} , 50mV/div
 TIME: 25.0μs/div

Medium Load Operation for Low ESR C_{OUT}

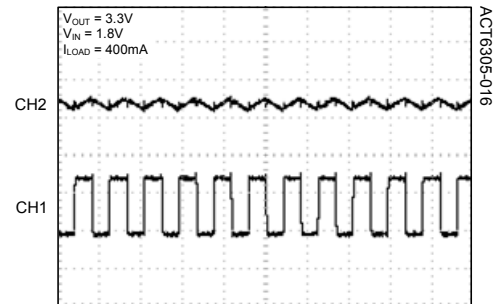

CH1: V_{LX} , 2.00V/div
 CH2: V_{OUT} , 100mV/div
 TIME: 2.50μs/div

FUNCTIONAL BLOCK DIAGRAM

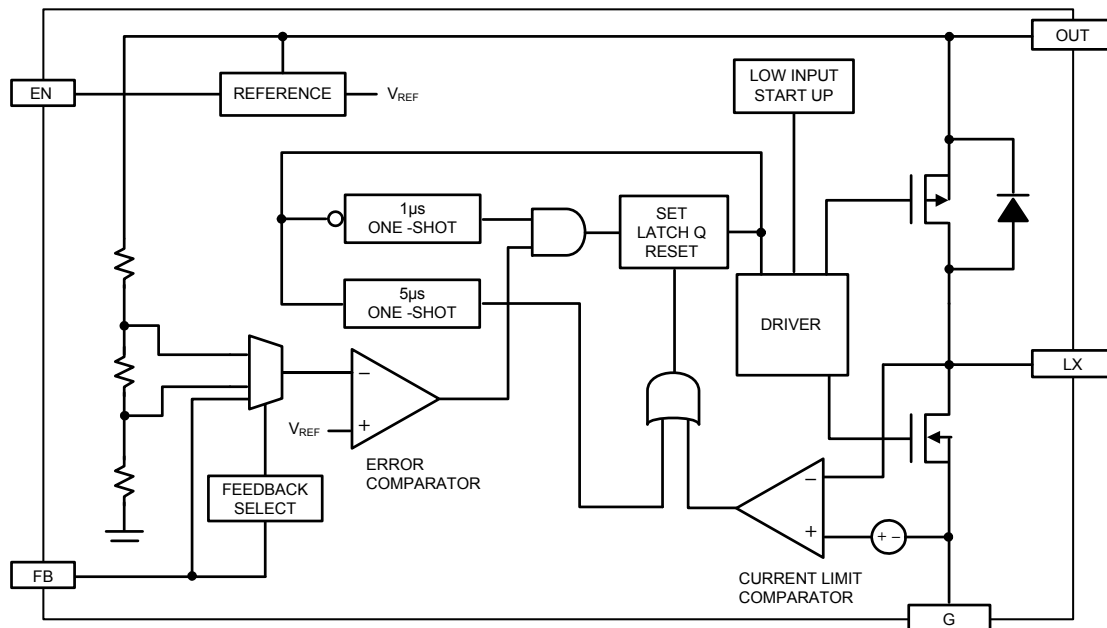

FUNCTIONAL DESCRIPTION

As seen in the *Functional Block Diagram*, the ACT6305 comprises a reference, low input startup circuitry, feedback select, error comparator, control logic and timers, internal power MOSFETs and current comparators.

Main Control Loop

The ACT6305 control architecture utilizes a series of one-shot and current sense circuits to regulate the output voltage with a very low quiescent supply current of just 17µA. An ON cycle begins when FB falls below the ACT6305's internal reference voltage. During an ON cycle, the N-channel power switch is turned on to connect the LX node to ground, transferring energy from input supply to the inductor. The ON cycle persists or the 1A current limit is reached. When either of these conditions occurs, the N-channel power switch turns off and the OFF cycle begins. During the OFF cycle, the energy stored in the inductor is released into the output capacitor and load through the synchronous rectifier. Once the 1µs minimum OFF time expires, another ON cycle begins when the FB voltage drops below the reference voltage.

Light Load Operation

Under light load conditions, the IC automatically enters a power-saving mode by extending the OFF time. This reduces switching losses and allows the ACT6305 to maintain high efficiency across a very wide load range.

Low Voltage Startup

The ACT6305 uses proprietary start-up circuitry that allows it to achieve very low voltage startup down to 1V. The ACT6305 remains in low voltage startup mode until V_{OUT} exceeds 1.85V. The ACT6305 cannot support its full rated load current when operating in low-voltage startup mode. Care should be taken to minimize load current during startup.

Shutdown

In shutdown mode, all internal circuits including the power switch and the synchronous rectifier are disabled, reducing quiescent supply current to less than 1µA. Note that in shutdown mode, a DC path from the input supply to the output still exists due to the body diode of the synchronous rectifier.

APPLICATIONS INFORMATION

Output Voltage Selection

The ACT6305 provides fixed output voltage options of 3.3V or 5V, or the output voltage may be adjusted over a 2V to 5V range by connecting an external resistive voltage divider. When Output Voltage is set by external resistive voltage divider, add a 47pF to 150pF capacitor as feedforward capacitor (C_{FF}) as shown in Figure 1.

Table 1:

Output Voltage Programming

FB = OUT	$V_{OUT} = 3.3V$
FB = G	$V_{OUT} = 5V$
FB connect to resistive divider	$V_{OUT} = 1.18V (1 + R_{FB1}/R_{FB2})$

Figure 1:

Output Voltage Setting

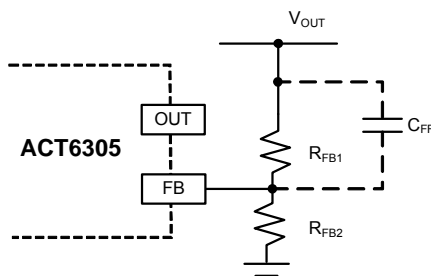

Output Capacitor Selection

A minimum value of output capacitance is required to maintain loop stability and normal operation of the IC. The output capacitor value should be in the range of 22 μ F to 100 μ F. To obtain small output ripple, use a large capacitor with low ESR. Ceramic capacitors should be used for highest performance. If a tantalum capacitor is used, choose only low ESR types and a smaller low ESR capacitor of about 1 μ F can be connected in parallel to filter high frequency noise.

Inductor Selection

For most applications, the inductor value should be in the range of 4.7 μ H to 22 μ H. Smaller inductors provide faster load transient response and have a smaller physical size, but they also result in higher ripple current and reduce the maximum available output current. Choose inductors with low series resistance to obtain the highest efficiency.

Board Layout

To reduce noise and increase efficiency, high current traces should be wide and direct, and an extended ground plane should be used. Switching current paths should be laid out as tightly as possible, with the inductor and input and output capacitors located close to the IC in order to reduce electromagnetic radiation.

If an external resistor divider is used, place the resistors very close to the FB and G pins, and keep them away from the high switching current paths.

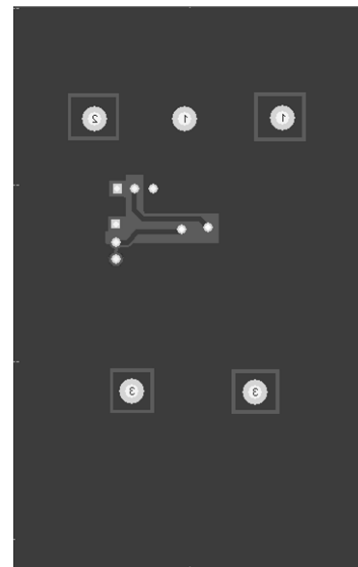
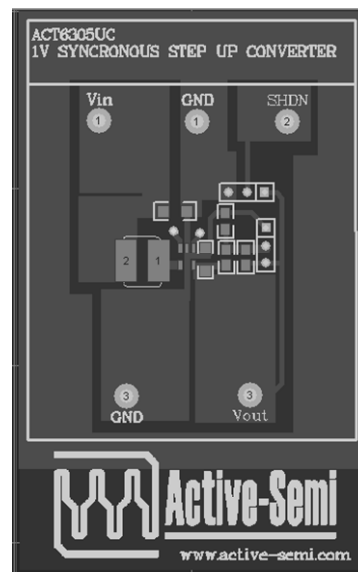

PACKAGE OUTLINE

SOT23-5 PACKAGE OUTLINE AND DIMENSIONS

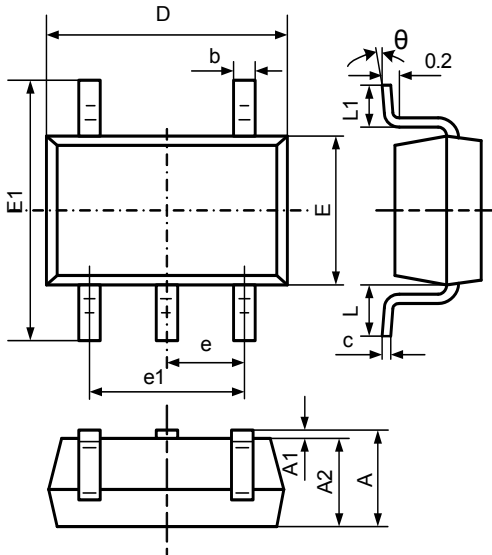

SYMBOL	DIMENSION IN MILLIMETERS		DIMENSION IN INCHES	
	MIN	MAX	MIN	MAX
A	-	1.450	-	0.057
A1	0.000	0.150	0.000	0.006
A2	0.900	1.300	0.035	0.051
b	0.300	0.500	0.012	0.020
c	0.080	0.220	0.003	0.009
D	2.900 BSC		0.114 BSC	
E	1.600 BSC		0.063 BSC	
E1	2.800 BSC		0.110 BSC	
e	0.950 BSC		0.037 BSC	
e1	1.900 BSC		0.075 BSC	
L	0.60REF		0.024REF	
L1	0.300	0.600	0.012	0.024
θ	0°	8°	0°	8°

Active-Semi, Inc. reserves the right to modify the circuitry or specifications without notice. Users should evaluate each product to make sure that it is suitable for their applications. Active-Semi products are not intended or authorized for use as critical components in life-support devices or systems. Active-Semi, Inc. does not assume any liability arising out of the use of any product or circuit described in this datasheet, nor does it convey any patent license.

Active-Semi and its logo are trademarks of Active-Semi, Inc. For more information on this and other products, contact sales@active-semi.com or visit <http://www.active-semi.com>.

 is a registered trademark of Active-Semi.