

1.8V 1A Regulator

Features

- Output current in excess of 1A
- Output voltage accuracy +2.5%/-2%
- Quiescent current, typically 480μA
- Internal short circuit current limit
- Internal over temperature protection

Applications

- PC motherboard
- ADSL/Cable Modem
- Set-Top-Box
- LAN switch/Hub
- Broad band access

General Description

The G952 positive 1.8V voltage regulator features the ability to source 1A of output current. The typical quiescent current is 0.48mA.

Familiar regulator features such as over temperature and over current protection circuits are provided to prevent it from being damaged by abnormal operating conditions.

Ordering Information

ORDER NUMBER	ORDER NUMBER (Pb free)	TEMP. RANGE	PACKAGE	PIN OPTION		
				1	2	3
G952T23U	G952T23Uf	-40°C~85°C	SOT-89	GND	V _{OUT}	V _{IN}
G952T24U	G952T24Uf	-40°C~85°C	SOT-89	GND	V _{IN}	V _{OUT}
G952T25U	G952T25Uf	-40°C~85°C	SOT-89	V _{IN}	GND	V _{OUT}
G952T43U	G952T43Uf	-40°C~85°C	TO-252	GND	V _{OUT}	V _{IN}
G952T63U	G952T63Uf	-40°C~85°C	SOT-223	GND	V _{OUT}	V _{IN}
G952T65U	G952T65Uf	-40°C~85°C	SOT-223	V _{IN}	GND	V _{OUT}

* For other package types and pin options, please contact us at sales@gmt.com.tw

Order Number Identification

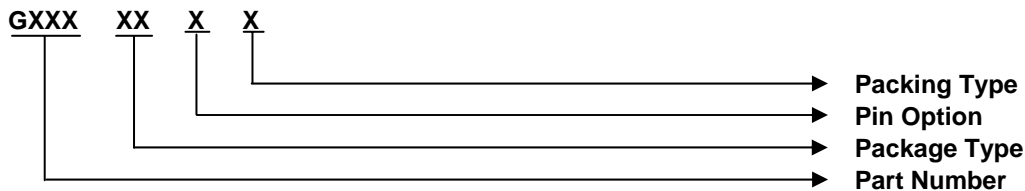

PACKAGE TYPE

T2: SOT-89
T4: TO-252
T6: SOT-223

PIN OPTION

1	2	3
1: V _{OUT}	GND	V _{IN}
2: V _{OUT}	V _{IN}	GND
3: GND	V _{OUT}	V _{IN}
4: GND	V _{IN}	V _{OUT}
5: V _{IN}	GND	V _{OUT}
6: V _{IN}	V _{OUT}	GND

PACKING

U : Tape & Reel

Package Type

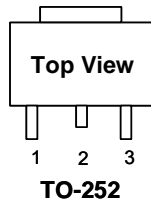
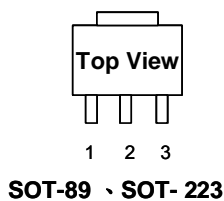

Typical Application

[Note 4]: Type of C_{OUT}

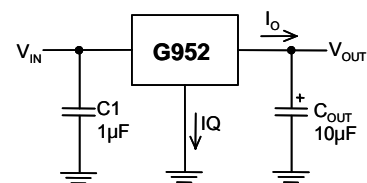



Absolute Maximum Ratings	(Note 1)
Input Voltage	7V
Power Dissipation Internally Limited	(Note 2)
Maximum Junction Temperature	150°C
Storage Temperature	
Range	$.65^{\circ}\text{C} \leq T_J \leq +150^{\circ}\text{C}$
Reflow Temperature (soldering, 10sec)	260°C
Thermal Resistance Junction to Ambient, (θ_{JA})	
SOT-89	173°C/W
SOT-223	148°C/W
TO-252	124°C/W
Thermal Resistance Junction to Case, (θ_{JC})	
SOT-89	25°C/W
SOT-223	22°C/W
TO-252	7°C/W

Operating Conditions	(Note 1)
Input Voltage	2.7V~6.5V
Temperature Range	$-40^{\circ}\text{C} \leq T_A \leq 85^{\circ}\text{C}$

Note ⁽¹⁾: See Recommended Minimum Footprint

Electrical Characteristics

$V_{IN} = 3.3V$, $I_O = 1A$, $C_{IN} = 1\mu F$, $C_{OUT} = 10\mu F$, All specifications apply for $T_A = T_J = 25^{\circ}\text{C}$. [Note 3]

PARAMETER	CONDITION		MIN	TYP	MAX	UNIT
Output Voltage	$10\text{mA} \leq I_O \leq 1A$		1.764	1.800	1.845	V
	$10\text{mA} \leq I_O \leq 550\text{mA}$ (SOT-89)		1.764	1.800	1.845	V
Line Regulation	$3V \leq V_{IN} \leq 6.5V$, $I_O = 10\text{mA}$		---	3	30	mV
Load Regulation	$10\text{mA} \leq I_O \leq 1A$		---	30	50	mV
	$10\text{mA} \leq I_O \leq 550\text{mA}$ (SOT-89)		---	30	50	mV
Output Impedance	200mA DC and 100mA AC, $f_o = 120\text{Hz}$		---	80	---	mΩ
Quiescent Current	$V_{IN} = 3.3V$		300	480	1500	μA
Ripple Rejection	$f_i = 120\text{Hz}$, $V_{\text{ripple}} = 1V_{P-P}$, $I_O = 100\text{mA}$		---	53	---	dB
Dropout Voltage	$I_O = 0A$		---	880	---	mV
	$I_O = 100\text{mA}$		---	895	---	
	$I_O = 500\text{mA}$ for (SOT-89, SOT-223, TO-252)		---	950	---	
	$I_O = 1A$ only for (SOT-223, TO-252)		---	1160	---	
Output Current	Continuous Test, $T_A = 25^{\circ}\text{C}$, $T_J 150^{\circ}\text{C}$, V_{OUT} within $\pm 2\%$	$V_{IN} = 3V$ (SOT-223) Minimum footprint (0.0625 square inch)	---	660	---	mA
		$V_{IN} = 3.3V$ (SOT-223) Mounted on 0.53 square inch pcb area	---	1	---	A
		$V_{IN} = 3.3V$ (SOT-89) Mounted on 0.16 square inch pcb area	---	0.5	---	A
Short Circuit Current			---	1.6	---	A
Over Temperature			---	150	---	°C

Note 1: Absolute Maximum Ratings are limits beyond which damage to the device may occur. Operating Conditions are conditions under which the device functions but the specifications might not be guaranteed. For guaranteed specifications and test conditions see the Electrical Characteristics.

Note2: The maximum power dissipation is a function of the maximum junction temperature, T_{Jmax} ; total thermal resistance, θ_{JA} , and ambient temperature T_A . The maximum allowable power dissipation at any ambient temperature is $T_{Jmax} - T_A / \theta_{JA}$. If this dissipation is exceeded, the die temperature will rise above 150°C and IC will go into thermal shutdown. For the G952 in SOT-89 package. θ_{JA} is 173°C/W For the G952 in SOT-223 package, θ_{JA} is 148°C/W, in TO-252 package, θ_{JA} is 124°C/W. (See recommend minimum footprint). The safe operation in SOT- 89, SOT-223, TO-252 package, it can see "Typical Performance Characteristics" (Safe Operating Area).

Note3: Low duty pulse techniques are used during test to maintain junction temperature as close to ambient as possible.

Note4: The type of output capacitor should be tantalum or aluminum.



Definitions

Dropout Voltage

The input/output Voltage differential at which the regulator output no longer maintains regulation against further reductions in input voltage. Measured when the output drops 100mV below its nominal value. Dropout voltage is affected by junction temperature, load current and minimum input supply requirements.

Line Regulation

The change in output voltage for a change in input voltage. The measurement is made under conditions of low dissipation or by using pulse techniques such that average chip temperature is not significantly affected.

Load Regulation

The change in output voltage for a change in load current at constant chip temperature. The measurement is made under conditions of low dissipation or by using pulse techniques such that average chip temperature is not significantly affected.

Maximum Power Dissipation

The maximum total device dissipation for which the regulator will operate within specifications.

Quiescent Bias Current

Current which is used to operate the regulator chip and is not delivered to the load.



Typical Performance Characteristics

(VIN= +3.3V, CIN=1μF, COUT=10μF, TA=25°C, unless otherwise noted.)

Line Transient

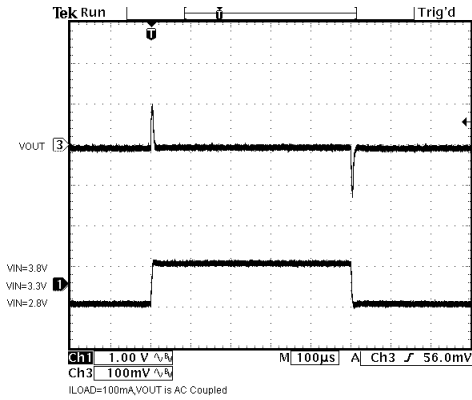

Line Transient

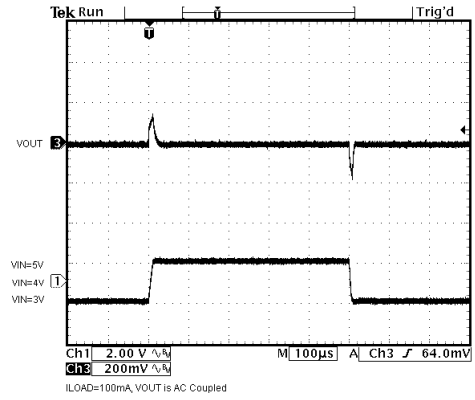

Load Transient

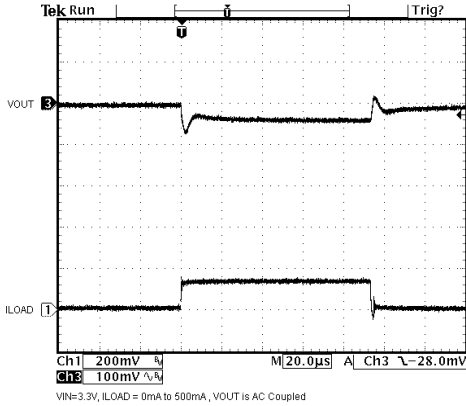

Load Transient

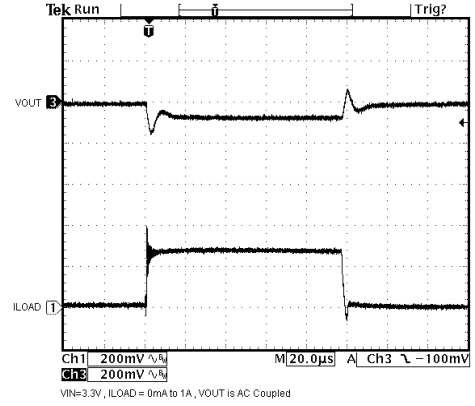

Load Transient

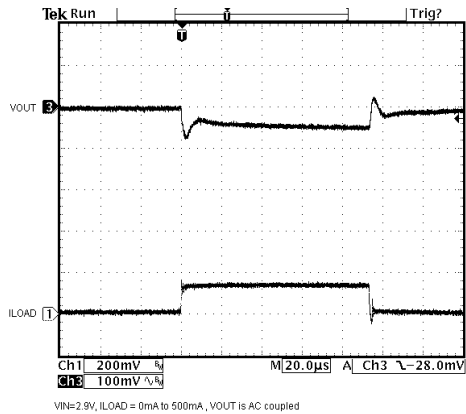

Load Transient

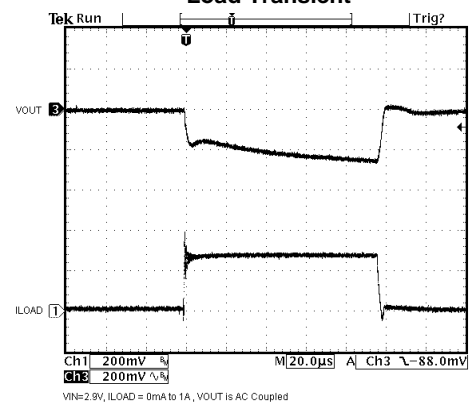



Typical Performance Characteristics (continued)

Line Transient Response (SOT-89)

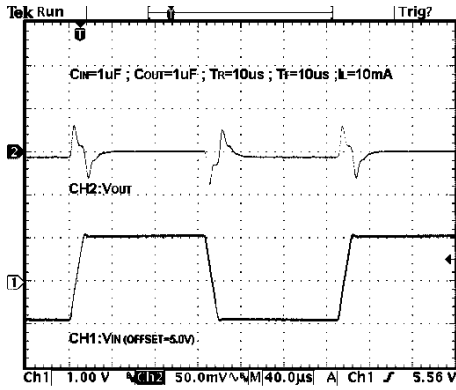

Load Transient Response (SOT-89)

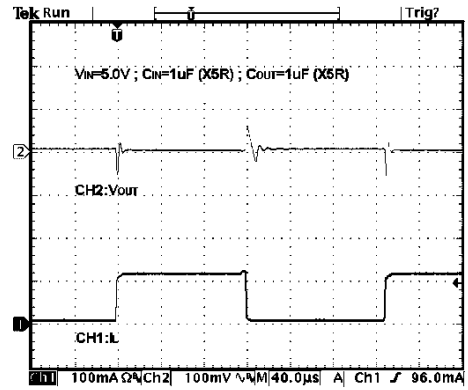

Short Circuit Current (SOT-89)

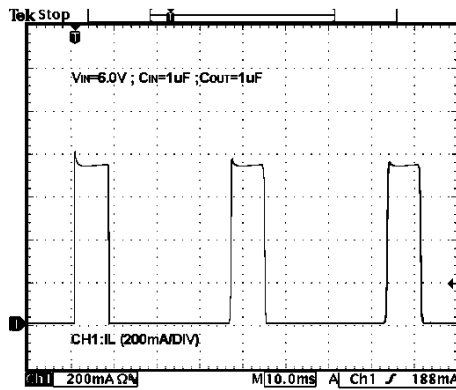

Overcurrent Protection Characteristics (SOT-89)

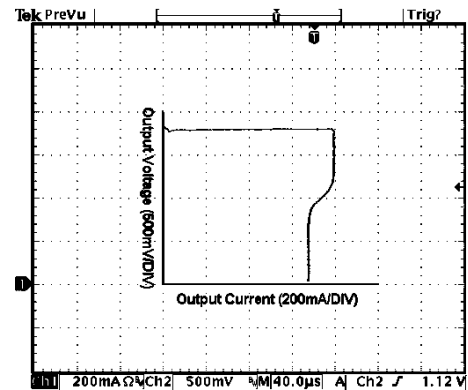

Start-up (SOT-89)

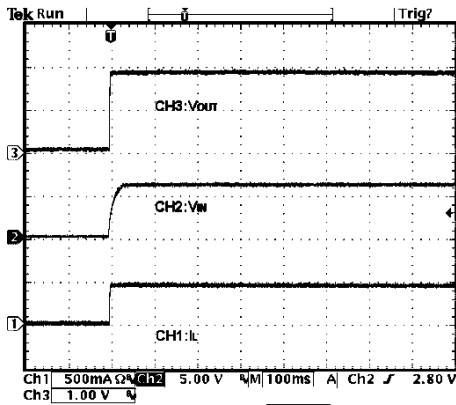

Ripple Rejection (SOT-89)

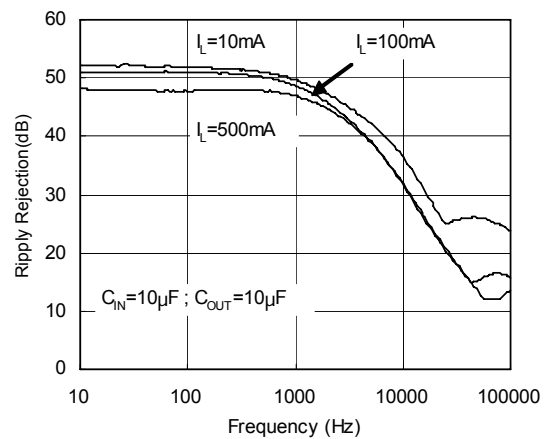



Typical Performance Characteristics (continued)

Quiescent Current vs. V_{IN} (SOT-89)

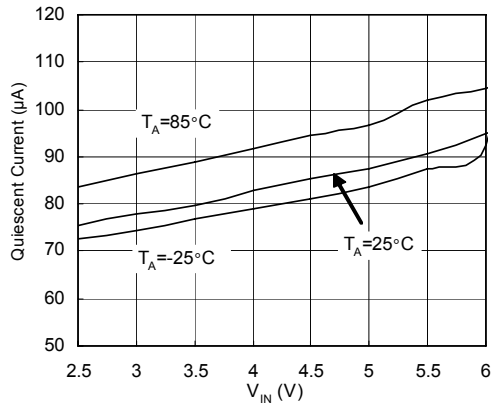

Output Voltage vs. I_L (SOT-89)

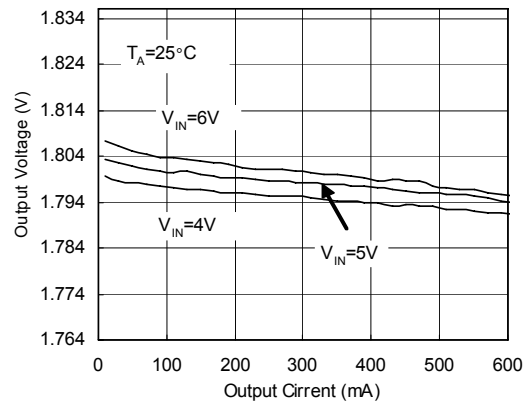

Output Voltage vs. T_A (SOT-89)

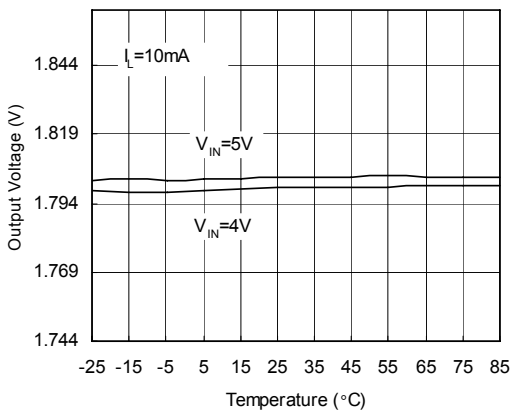

Dropout Voltage vs. I_L (SOT-89)

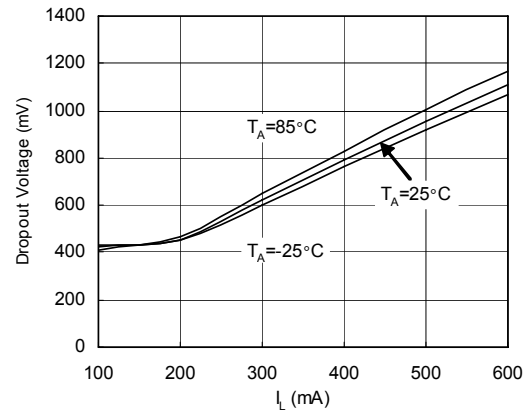

Output Voltage vs. Load Current

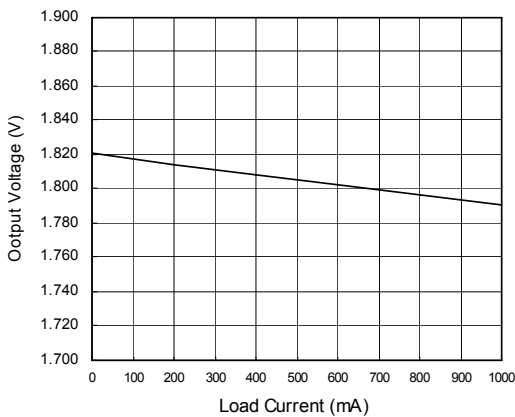

Dropout Voltage vs. Load Current

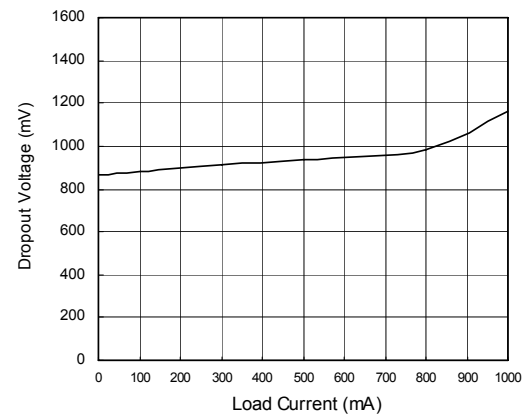

Typical Performance Characteristics (continued)

Ground Current vs. Load Current

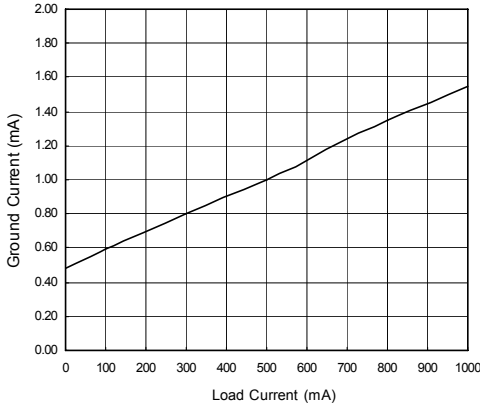

Safe Operating Area of SOT-223

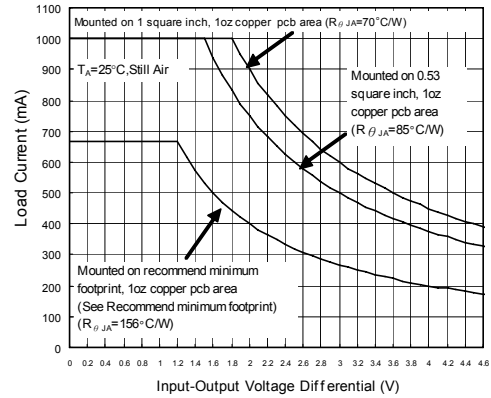

SOT-223 Max. Power Dissipation vs. PCB Top Copper Area
 $T_{AMB} = 25^{\circ}C$; Still Air

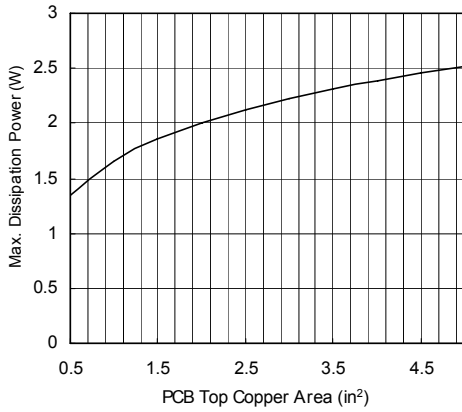

SOT-223 Max. Power Dissipation vs. T_{AMB} (still air)
 (Different PCB Top Copper Area)

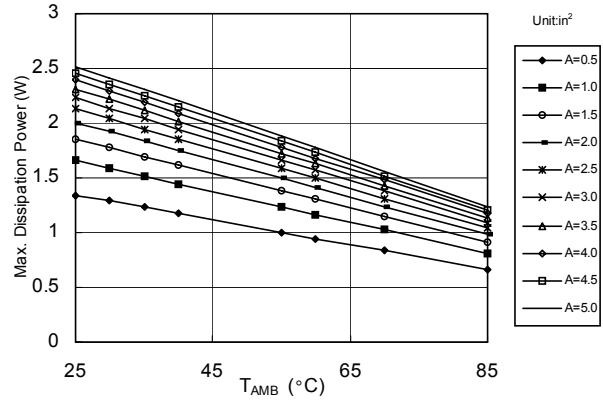

SOT-89 Max. Power Dissipation vs. PCB Top Copper Area
 $T_{AMB} = 25^{\circ}C$; Still Air

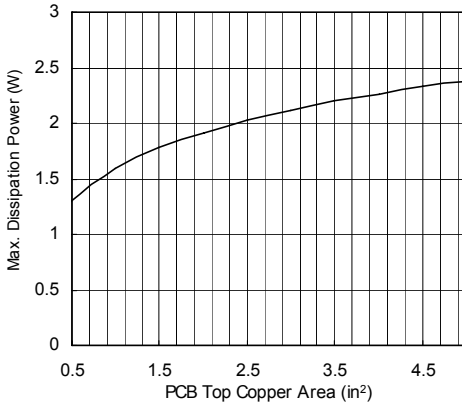

SOT-89 Max. Power Dissipation vs. T_{AMB} (still air)
 (Different PCB Top Copper Area)

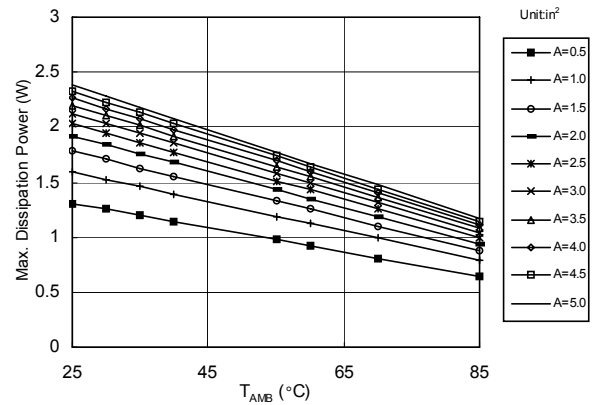

Typical Performance Characteristics (continued)

SOT-252 Max. Power Dissipation vs. PCB Top Copper Area
 $T_{AMB} = 25^{\circ}C$; Still Air

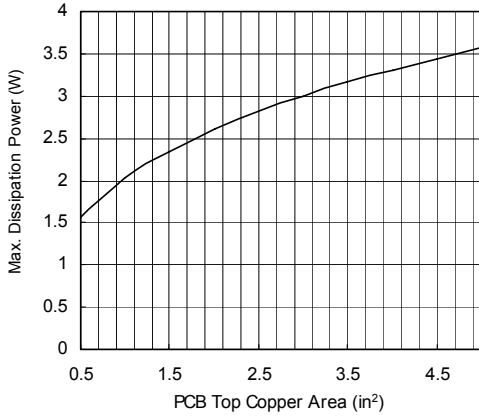

SOT-252 Max. Power Dissipation vs. T_{AMB} (still air)
 (Different PCB Top Copper Area)

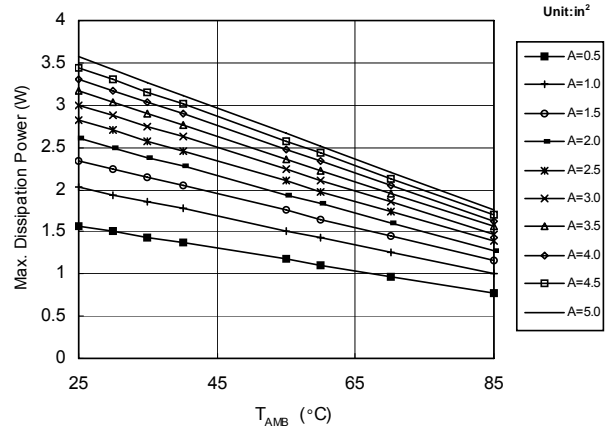

Recommended Minimum Footprint

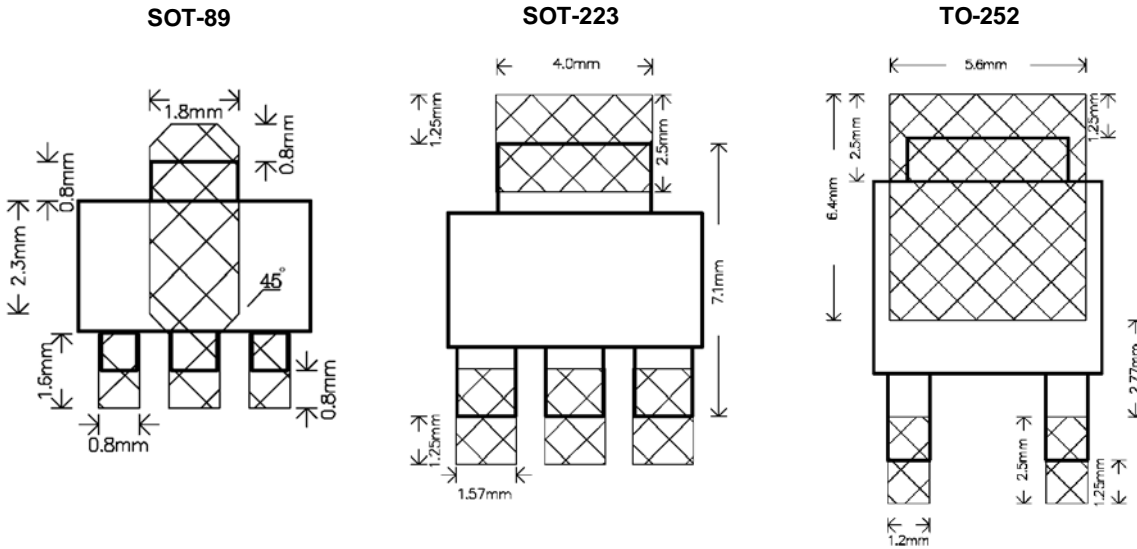

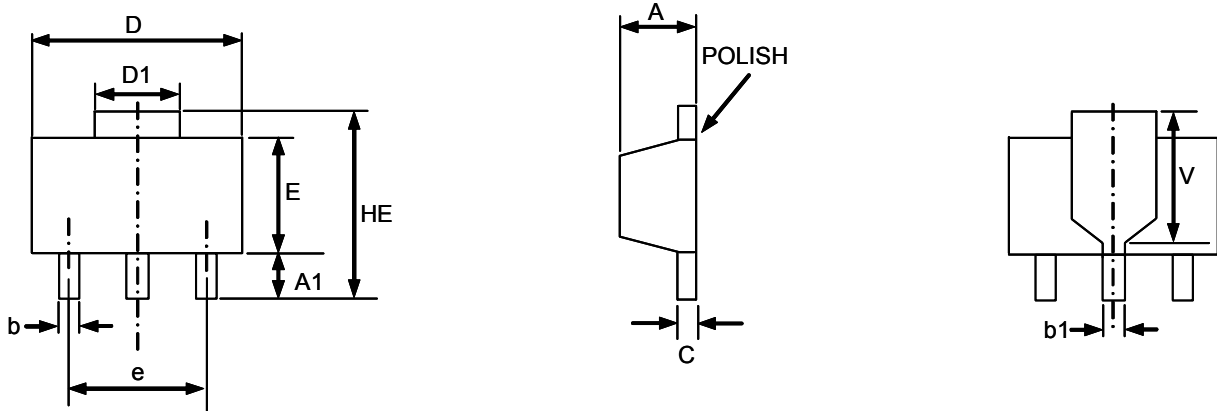
Package Information

SOT-89 (T2) Package

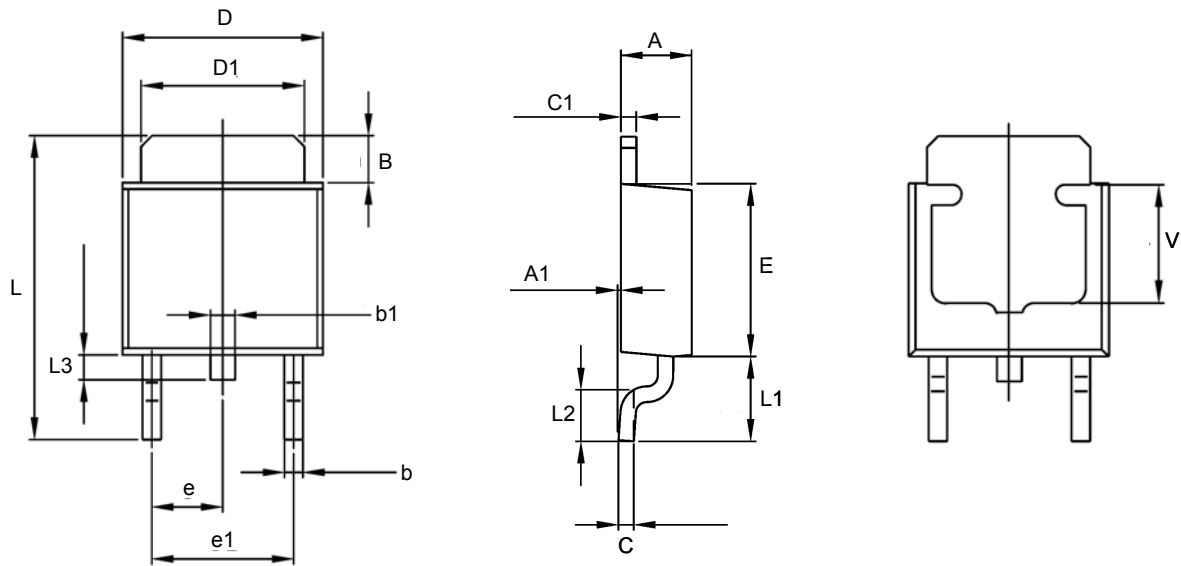
SYMBOL	DIMENSIONS IN MILLIMETER			DIMENSIONS IN INCHE		
	MIN	NOM	MAX	MIN	NOM	MAX
A	1.40	1.50	1.60	0.055	0.059	0.063
A1	0.80	1.04	-----	0.031	0.041	-----
b	0.36	0.42	0.48	0.014	0.016	0.018
b1	0.41	0.47	0.53	0.016	0.018	0.020
C	0.38	0.40	0.43	0.014	0.015	0.017
D	4.40	4.50	4.60	0.173	0.177	0.181
D1	1.40	1.60	1.75	0.055	0.062	0.069
HE	-----	-----	4.25	-----	-----	0.167
E	2.40	2.50	2.60	0.094	0.098	0.102
e	2.90	3.00	3.10	0.114	0.118	0.122
V	-----	2.60	-----	-----	0.102	-----

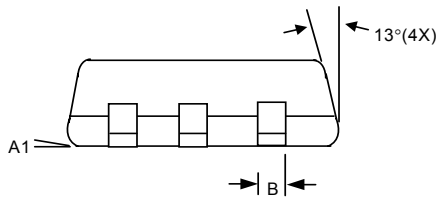
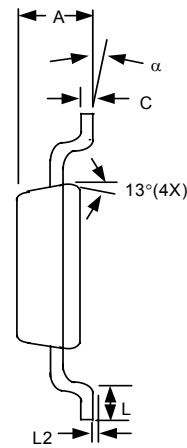
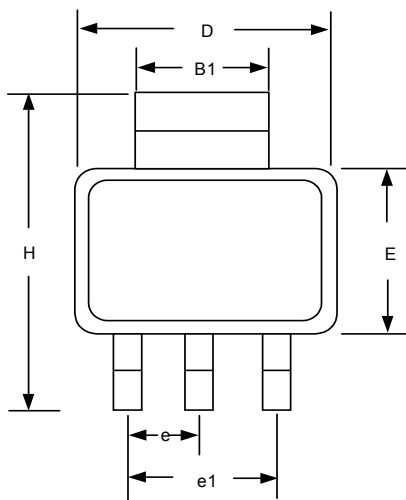

TO-252 (T4) Package

SYMBOL	MILLIMETERS		INCHES	
	MIN	MAX	MIN	MAX
A	2.190	2.400	0.086	0.094
A1	0.000	0.127	0.000	0.005
B	0.880	1.650	0.035	0.065
b	0.500	0.880	0.020	0.035
b1	0.700	0.900	0.028	0.035
C	0.430	0.580	0.017	0.023
C1	0.430	0.580	0.017	0.023
D	6.350	6.730	0.250	0.265
D1	5.200	5.460	0.205	0.215
E	5.400	6.220	0.213	0.245
e	2.300 TYP		0.091 TYP	
e1	4.500	4.700	0.177	0.185
L	8.830	10.77	0.348	0.424
L1	2.550	2.900	0.100	0.114
L2	1.400	1.780	0.055	0.070
L3	0.350	1.020	0.014	0.040
V	3.800	4.320	0.150	0.170



SOT-223 (T6) Package

SYMBOLS	MILLIMETERS		INCHES	
	MIN	MAX	MIN	MAX
A	1.55	1.80	0.061	0.071
A1	0.02	0.12	0.0008	0.0047
B	0.60	0.80	0.024	0.031
B1	2.90	3.10	0.114	0.122
C	0.24	0.32	0.009	0.013
D	6.30	6.70	0.248	0.264
E	3.30	3.70	0.130	0.146
e	2.30 BSC		0.090 BSC	
e1	4.60 BSC		0.181 BSC	
H	6.70	7.30	0.264	0.287
L	0.90 MIN		0.036 MIN	
L2	0.06 BSC		0.0024 BSC	
α	0°	10°	0°	10°

Taping Specification

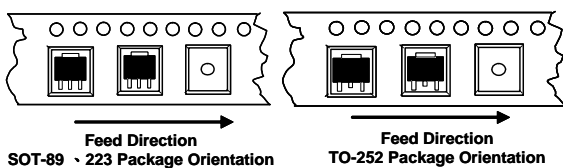

PACKAGE	Q'TY/REEL
SOT-89	1,000 ea
SOT-223	2,500 ea
TO-252	2,500 ea

GMT Inc. does not assume any responsibility for use of any circuitry described, no circuit patent licenses are implied and GMT Inc. reserves the right at any time without notice to change said circuitry and specifications.