

74AC299 • 74ACT299

8-Input Universal Shift/Storage Register with Common Parallel I/O Pins

General Description

The AC/ACT299 is an 8-bit universal shift/storage register with 3-STATE outputs. Four modes of operation are possible: hold (store), shift left, shift right and load data. The parallel load inputs and flip-flop outputs are multiplexed to reduce the total number of package pins. Additional outputs are provided for flip-flops Q_0 , Q_7 to allow easy serial cascading. A separate active LOW Master Reset is used to reset the register.

Features

- I_{CC} and I_{OZ} reduced by 50%
- Common parallel I/O for reduced pin count
- Additional serial inputs and outputs for expansion
- Four operating modes: shift left, shift right, load and store
- 3-STATE outputs for bus-oriented applications
- Outputs source/sink 24 mA
- ACT299 has TTL-compatible inputs

Ordering Code:

Order Number	Package Number	Package Description
74AC299SC	M20B	20-Lead Small Outline Integrated Circuit (SOIC), JEDEC MS-013, 0.300" Wide
74AC299SCX_NL (Note 1)	M20B	Pb-Free 20-Lead Small Outline Integrated Circuit (SOIC), JEDEC MS-013, 0.300" Wide
74AC299SJ	M20D	Pb-Free 20-Lead Small Outline Package (SOP), EIAJ TYPE II, 5.3mm Wide
74AC299MTC	MTC20	20-Lead Thin Shrink Small Outline Package (TSSOP), JEDEC MO-153, 4.4mm Wide
74AC299PC	N20A	20-Lead Plastic Dual-In-Line Package (PDIP), JEDEC MS-001, 0.300" Wide
74ACT299SC	M20B	20-Lead Small Outline Integrated Circuit (SOIC), JEDEC MS-013, 0.300" Wide
74ACT299MTC	MTC20	20-Lead Thin Shrink Small Outline Package (TSSOP), JEDEC MO-153, 4.4mm Wide
74ACT299PC	N20A	20-Lead Plastic Dual-In-Line Package (PDIP), JEDEC MS-001, 0.300" Wide

Device also available in Tape and Reel. Specify by appending suffix letter "X" to the ordering code.
Pb-Free package per JEDEC J-STD-020B.

Note 1: "_NL" indicates Pb-Free package (per JEDEC J-STD-020B). Device available in Tape and Reel only.

Connection Diagram

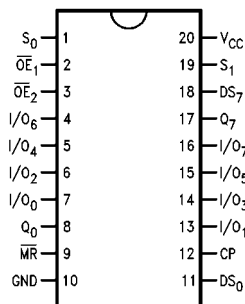

Pin Descriptions

Pin Names	Description
CP	Clock Pulse Input
DS_0	Serial Data Input for Right Shift
DS_7	Serial Data Input for Left Shift
S_0, S_1	Mode Select Inputs
\overline{MR}	Asynchronous Master Reset
$\overline{OE}_1, \overline{OE}_2$	3-STATE Output Enable Inputs
$I/O_0-I/O_7$	Parallel Data Inputs or 3-STATE Parallel Outputs
Q_0, Q_7	Serial Outputs

FACT™ is a trademark of Fairchild Semiconductor Corporation.

Logic Symbols

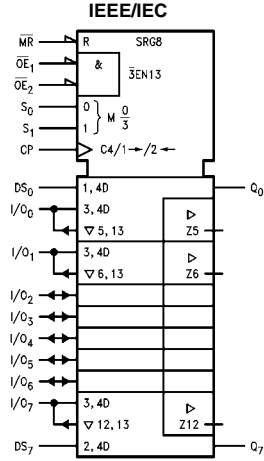
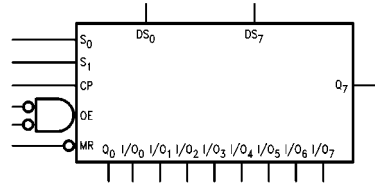

Truth Table

Inputs				Response
MR	S ₁	S ₀	CP	
L	X	X	X	Asynchronous Reset; Q ₀ -Q ₇ = LOW
H	H	H	↔	Parallel Load; I/O _n → Q _n
H	L	H	↔	Shift Right; DS ₀ → Q ₀ , Q ₀ → Q ₁ , etc.
H	H	L	↔	Shift Left, DS ₇ → Q ₇ , Q ₇ → Q ₆ , etc.
H	L	L	X	Hold

H = HIGH Voltage Level
 L = LOW Voltage Level
 X = Immaterial
 ↔ = LOW-to-HIGH Transition

Functional Description

The AC/ACT299 contains eight edge-triggered D-type flip-flops and the interstage logic necessary to perform synchronous shift left, shift right, parallel load and hold operations. The type of operation is determined by S₀ and S₁, as shown in the Truth Table. All flip-flop outputs are brought out through 3-STATE buffers to separate I/O pins that also serve as data inputs in the parallel load mode. Q₀ and Q₇ are also brought out on other pins for expansion in serial shifting of longer words.

A LOW signal on MR overrides the Select and CP inputs and resets the flip-flops. All other state changes are initiated by the rising edge of the clock. Inputs can change when the clock is in either state provided only that the recommended setup and hold times, relative to the rising edge of CP, are observed.

A HIGH signal on either OE₁ or OE₂ disables the 3-STATE buffers and puts the I/O pins in the high impedance state. In this condition the shift, hold, load and reset operations can still occur. The 3-STATE buffers are also disabled by HIGH signals on both S₀ and S₁ in preparation for a parallel load operation.

Logic Diagram

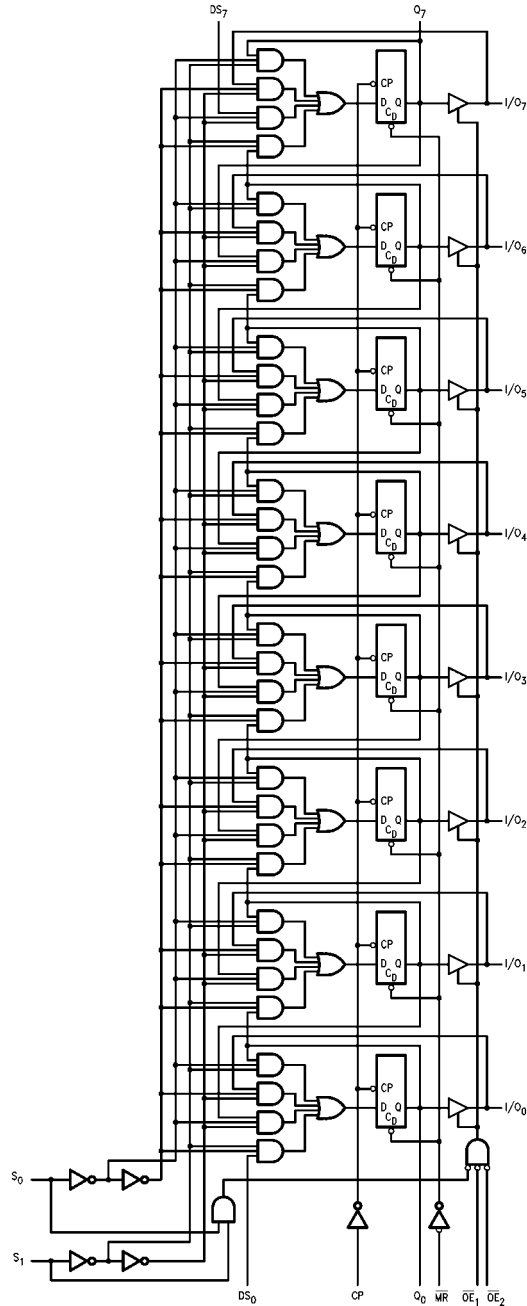

Please note that this diagram is provided only for the understanding of logic operations and should not be used to estimate propagation delays.

Absolute Maximum Ratings (Note 2)

Supply Voltage (V_{CC})	-0.5V to +7.0V
DC Input Diode Current (I_{IK})	
$V_I = -0.5V$	-20 mA
$V_I = V_{CC} + 0.5V$	+20 mA
DC Input Voltage (V_I)	-0.5V to $V_{CC} + 0.5V$
DC Output Diode Current (I_{OK})	
$V_O = -0.5V$	-20 mA
$V_O = V_{CC} + 0.5V$	+20 mA
DC Output Voltage (V_O)	-0.5V to $V_{CC} + 0.5V$
DC Output Source or Sink Current (I_O)	± 50 mA
DC V_{CC} or Ground Current	
Per Output Pin (I_{CC} or I_{GND})	± 50 mA
Storage Temperature (T_{STG})	-65°C to +150°C
Junction Temperature (T_J)	
(PDIP)	140°C

Recommended Operating Conditions

Supply Voltage (V_{CC})	(Unless Otherwise Specified)	
AC		2.0V to 6.0V
ACT		4.5V to 5.0V
Input Voltage (V_I)		0V to V_{CC}
Output Voltage (V_O)		0V to V_{CC}
Operating Temperature (T_A)		-40°C to +85°C
Minimum Input Edge Rate ($\Delta V/\Delta t$)		
AC Devices		
V_{IN} from 30% to 70% of V_{CC}		
V_{CC} @ 3.3V, 4.5V, 5.5V		125 mV/ns
Minimum Input Edge Rate ($\Delta V/\Delta t$)		
ACT Devices		
V_{IN} from 0.8V to 2.0V		
V_{CC} @ 4.5V, 5.5V		125 mV/ns

Note 2: Absolute maximum ratings are those values beyond which damage to the device may occur. Obviously the databook specifications should be met, without exception, to ensure that the system design is reliable over its power supply, temperature, and output/input loading variables. Fairchild does not recommend operation of FACT™ circuits outside databook specifications.

DC Electrical Characteristics for AC

Symbol	Parameter	V_{CC} (V)	$T_A = 25^\circ\text{C}$		$T_A = -40^\circ\text{C to } +85^\circ\text{C}$		Units	Conditions
			Typ	Guaranteed Limits				
V_{IH}	Minimum HIGH Level Input Voltage	3.0	1.5	2.1	2.1	V	$V_{OUT} = 0.1V$ or $V_{CC} - 0.1V$	
		4.5	2.25	3.15	3.15			
		5.5	2.75	3.85	3.85			
V_{IL}	Maximum LOW Level Input Voltage	3.0	1.5	0.9	0.9	V	$V_{OUT} = 0.1V$ or $V_{CC} - 0.1V$	
		4.5	2.25	1.35	1.35			
		5.5	2.75	1.65	1.65			
V_{OH}	Minimum HIGH Level Output Voltage	3.0	2.99	2.9	2.9	V	$I_{OUT} = -50 \mu\text{A}$	
		4.5	4.49	4.4	4.4			
		5.5	5.49	5.4	5.4			
		3.0		2.56	2.46	V	$V_{IN} = V_{IL}$ or V_{IH} $I_{OH} = -12 \text{ mA}$ $I_{OH} = -24 \text{ mA}$ $I_{OH} = -24 \text{ mA (Note 3)}$	
		4.5		3.86	3.76			
		5.5		4.86	4.76			
V_{OL}	Maximum LOW Level Output Voltage	3.0	0.002	0.1	0.1	V	$I_{OUT} = 50 \mu\text{A}$	
		4.5	0.001	0.1	0.1			
		5.5	0.001	0.1	0.1			
		3.0		0.36	0.44	V	$V_{IN} = V_{IL}$ or V_{IH} $I_{OH} = 12 \text{ mA}$ $I_{OH} = 24 \text{ mA}$ $I_{OH} = 24 \text{ mA (Note 3)}$	
		4.5		0.36	0.44			
		5.5		0.36	0.44			
I_{IN} (Note 5)	Maximum Input Leakage Current	5.5		± 0.1	± 1.0	μA	$V_I = V_{CC}, \text{ GND}$	
I_{OLD}	Minimum Dynamic	5.5			86	mA	$V_{OLD} = 1.65V \text{ Max}$	
I_{OHD}	Output Current (Note 4)				-75	mA	$V_{OHD} = 3.85V \text{ Min}$	
I_{CC} (Note 5)	Maximum Quiescent Supply Current	5.5		4.0	40.0	μA	$V_{IN} = V_{CC}$ or GND	

DC Electrical Characteristics for AC (Continued)

Symbol	Parameter	V _{CC} (V)	T _A = 25°C		T _A = -40°C to +85°C		Units	Conditions
			Typ	Guaranteed Limits		Guaranteed Limits		
I _{OZT}	Maximum I/O Leakage Current	5.5		± 0.3	± 3.0		µA	V _I (OE) = V _{IL} , V _{IH} V _I = V _{CC} , GND V _O = V _{CC} , GND

Note 3: All outputs loaded; threshold on input associated with output under test.

Note 4: Maximum test duration 20 ms, one output loaded at a time.

Note 5: I_{IN} and I_{CC} @ 3.0V are guaranteed to be less than or equal to the respective limit @ 5.5V V_{CC}.

DC Electrical Characteristics for ACT

Symbol	Parameter	V _{CC} (V)	T _A = 25°C		T _A = -40°C to +85°C		Units	Conditions
			Typ	Guaranteed Limits		Guaranteed Limits		
V _{IH}	Minimum HIGH Level Input Voltage	4.5	1.5	2.0	2.0		V	V _{OUT} = 0.1V or V _{CC} - 0.1V
		5.5	1.5	2.0	2.0			
V _{IL}	Maximum LOW Level Input Voltage	3.0	1.5	0.8	0.8		V	V _{OUT} = 0.1V or V _{CC} - 0.1V
		4.5	1.5	0.8	0.8			
V _{OH}	Minimum HIGH Level	4.5	4.49	4.4	4.4		V	I _{OUT} = -50 µA
		5.5	5.49	5.4	5.4			
		4.5	0.0001	3.86	3.76		V	V _{IN} = V _{IL} or V _{IH} I _{OH} = -24 mA I _{OH} = -24 mA (Note 6)
		5.5		4.86	4.76			
V _{OL}	Maximum LOW Level Output Voltage	4.5	0.001	0.1	0.1		V	I _{OUT} = 50 µA
		5.5	0.001	0.1	0.1			
		4.5		0.36	0.44		V	V _{IN} = V _{IL} or V _{IH} I _{OL} = 24 mA I _{OL} = 24 mA (Note 6)
		5.5		0.36	0.44			
I _{IN}	Maximum Input Leakage Current	5.5		± 0.1	± 1.0		µA	V _I = V _{CC} , GND
I _{CCT}	Maximum I _{CC} /Input	5.5	0.6		1.5		mA	V _I = V _{CC} - 2.1V
I _{OLD}	Minimum Dynamic	5.5			75		mA	V _{OLD} = 1.65V Max
I _{OHD}	Output Current (Note 7)	5.5			-75		mA	V _{OHD} = 3.85V Min
I _{CC}	Maximum Quiescent Supply Current	5.5		4.0	40.0		µA	V _{IN} = V _{CC} or GND
I _{OZT}	Maximum I/O Leakage Current	5.5		±0.3	±3.0		µA	V _I (OE) = V _{IL} , V _{IH} V _I = V _{CC} , GND V _O = V _{CC} , GND

Note 6: All outputs loaded; thresholds on input associated with output under test.

Note 7: Maximum test duration 2.0 ms, one output loaded at a time.

AC Electrical Characteristics for AC

Symbol	Parameter	V _{CC} (V) (Note 8)	T _A = +25°C C _L = 50 pF			T _A = -40°C to +85°C C _L = 50 pF		Units
			Min	Typ	Max	Min	Max	
f _{MAX}	Maximum Input Frequency	3.3	90	124		80		MHz
		5.0	130	173		105		
t _{PLH}	Propagation Delay CP to Q ₀ or Q ₇ (Shift Left or Right)	3.3	8.5	14.0	20.5	7.0	22.0	ns
		5.0	5.5	9.5	14.0	4.5	15.0	
t _{PHL}	Propagation Delay CP to Q ₀ or Q ₇ (Shift Left or Right)	3.3	8.5	14.5	21.5	7.0	23.0	ns
		5.0	5.5	10.0	14.5	5.0	16.0	
t _{PLH}	Propagation Delay \overline{CP} to I/O _n	3.3	9.0	14.5	20.5	7.5	22.5	ns
		5.0	6.0	10.0	14.5	5.0	16.0	
t _{PHL}	Propagation Delay CP to I/O _n	3.3	10.0	16.0	23.0	8.5	24.5	ns
		5.0	6.5	11.0	16.0	6.0	17.5	
t _{PHL}	Propagation Delay MR to Q ₀ or Q ₇	3.3	9.0	15.5	22.5	7.5	25.0	ns
		5.0	5.5	10.5	15.5	5.0	17.0	
t _{PHL}	Propagation Delay \overline{MR} to I/O _n	3.3	9.0	15.0	21.5	7.5	24.0	ns
		5.0	5.5	10.0	15.0	5.0	16.5	
t _{PZH}	Output Enable Time \overline{OE} to I/O _n	3.3	7.0	12.0	18.0	6.0	19.5	ns
		5.0	4.5	8.5	12.5	4.0	13.5	
t _{PZL}	Output Enable Time \overline{OE} to I/O _n	3.3	7.0	12.5	18.0	6.0	20.5	ns
		5.0	5.0	8.0	12.5	4.0	14.0	
t _{PHZ}	Output Disable Time \overline{OE} to I/O _n	3.3	6.5	13.0	18.5	5.5	19.5	ns
		5.0	3.5	9.5	14.0	3.0	15.0	
t _{PLZ}	Output Disable Time \overline{OE} to I/O _n	3.3	5.5	11.5	17.0	4.5	19.0	ns
		5.0	3.5	8.0	12.5	2.0	13.5	

Note 8: Voltage Range 3.3 is 3.3V ± 0.3V.

Voltage Range 5.0 is 5.0V ± 0.5V.

AC Operating Requirements for AC

Symbol	Parameter	V _{CC} (V) (Note 9)	T _A = +25°C C _L = 50 pF		T _A = -40°C to +85°C C _L = 50 pF		Units
			Typ	Guaranteed Minimum			
t _S	Setup Time, HIGH or LOW S ₀ or S ₁ to CP	3.3	3.0	8.0	8.5		ns
		5.0	2.0	5.0	5.5		
t _H	Hold Time, HIGH or LOW S ₀ or S ₁ to CP	3.3	-3.0	0.5	0.5		ns
		5.0	-1.5	1.0	1.0		
t _S	Setup Time, HIGH or LOW I/O _n to CP	3.3	2.0	5.5	6.0		ns
		5.0	1.0	3.5	4.0		
t _H	Hold Time, HIGH or LOW I/O _n to CP	3.3	-2.0	0	0		ns
		5.0	-1.0	1.0	1.0		
t _S	Setup Time, HIGH or LOW DS ₀ or DS ₇ to CP	3.3	2.5	6.5	7.0		ns
		5.0	1.5	4.0	4.5		
t _H	Hold Time, HIGH or LOW DS ₀ or DS ₇ to CP	3.3	-2.0	0	0.5		ns
		5.0	-1.0	1.0	1.0		
t _W	CP Pulse Width, LOW	3.3	3.5	4.5	5.0		ns
		5.0	2.0	3.5	3.5		
t _W	\overline{MR} Pulse Width, LOW	3.3	4.0	4.5	5.0		ns
		5.0	2.0	3.5	3.5		
t _{REC}	Recovery Time \overline{MR} to CP	3.3	0	1.5	1.5		ns
		5.0	0.5	1.5	1.5		

Note 9: Voltage Range 3.3 is 3.3V ± 0.3V

Voltage Range 5.0 is 5.0V ± 0.5V

AC Electrical Characteristics for ACT

Symbol	Parameter	V _{CC} (V) (Note 10)	T _A = +25°C C _L = 50 pF			T _A = -40°C to +85°C C _L = 50 pF		Units
			Min	Typ	Max	Min	Max	
t _{MAX}	Maximum Input Frequency	5.0	120	170		110		MHz
t _{PLH}	Propagation Delay CP to Q ₀ or Q ₇ (Shift Left or Right)	5.0	4.0	8.5	12.5	3.0	14.0	ns
t _{PHL}	Propagation Delay CP to Q ₀ or Q ₇ (Shift Left or Right)	5.0	4.0	9.0	13.5	3.5	15.0	ns
t _{PLH}	Propagation Delay CP to I/O _n	5.0	4.5	8.5	12.5	4.5	13.5	ns
t _{PHL}	Propagation Delay CP to I/O _n	5.0	5.0	9.5	15.0	4.5	16.5	ns
t _{PHL}	Propagation Delay \overline{MR} to Q ₀ or Q ₇	5.0	4.0	14.0	15.0	4.0	18.0	ns
t _{PHL}	Propagation Delay \overline{MR} to I/O _n	5.0	4.0	13.0	14.5	3.5	17.5	ns
t _{PZH}	Output Enable Time \overline{OE} to I/O _n	5.0	2.5	8.0	12.0	1.5	13.0	ns
t _{PZL}	Output Enable Time \overline{OE} to I/O _n	5.0	2.0	8.0	12.0	1.5	13.5	ns
t _{PHZ}	Output Disable Time \overline{OE} to I/O _n	5.0	2.0	8.5	12.5	2.0	13.5	ns
t _{PLZ}	Output Disable Time \overline{OE} to I/O _n	5.0	2.5	8.0	11.5	2.0	12.5	ns

Note 10: Voltage Range 5.0 is 5.0V ± 0.5V

AC Operating Requirements for ACT

Symbol	Parameter	V _{CC} (V) (Note 11)	T _A = +25°C C _L = 50 pF		T _A = -40°C to +85°C C _L = 50 pF		Units
			Typ	Guaranteed Minimum			
t _S	Setup Time, HIGH or LOW S ₀ or S ₁ to CP	5.0	2.0	5.0	5.5		ns
t _H	Hold Time, HIGH or LOW S ₀ or S ₁ to CP	5.0	-2.0	1.0	1.0		ns
t _S	Setup Time, HIGH or LOW I/O _n to CP	5.0	1.5	4.0	4.5		ns
t _H	Hold Time, HIGH or LOW I/O _n to CP	5.0	-1.0	1.0	1.0		ns
t _S	Setup Time, HIGH or LOW DS ₀ or DS ₇ to CP	5.0	1.5	4.5	5.0		ns
t _H	Hold Time, HIGH or LOW DS ₀ or DS ₇ to CP	5.0	-1.0	1.0	1.0		ns
t _W	CP Pulse Width HIGH or LOW	5.0	2.0	4.0	4.5		ns
t _W	\overline{MR} Pulse Width, LOW	5.0	2.0	3.5	3.5		ns
t _{REC}	Recovery Time, \overline{MR} to CP	5.0	0	1.5	1.5		ns

Note 11: Voltage Range 5.0 is 5.0V ± 0.5V.

Capacitance

Symbol	Parameter	Typ	Units	Conditions
C _{IN}	Input Capacitance	4.5	pF	V _{CC} = 5.0V
C _{PD}	Power Dissipation Capacitance	170	pF	V _{CC} = 5.5V

Physical Dimensions inches (millimeters) unless otherwise noted

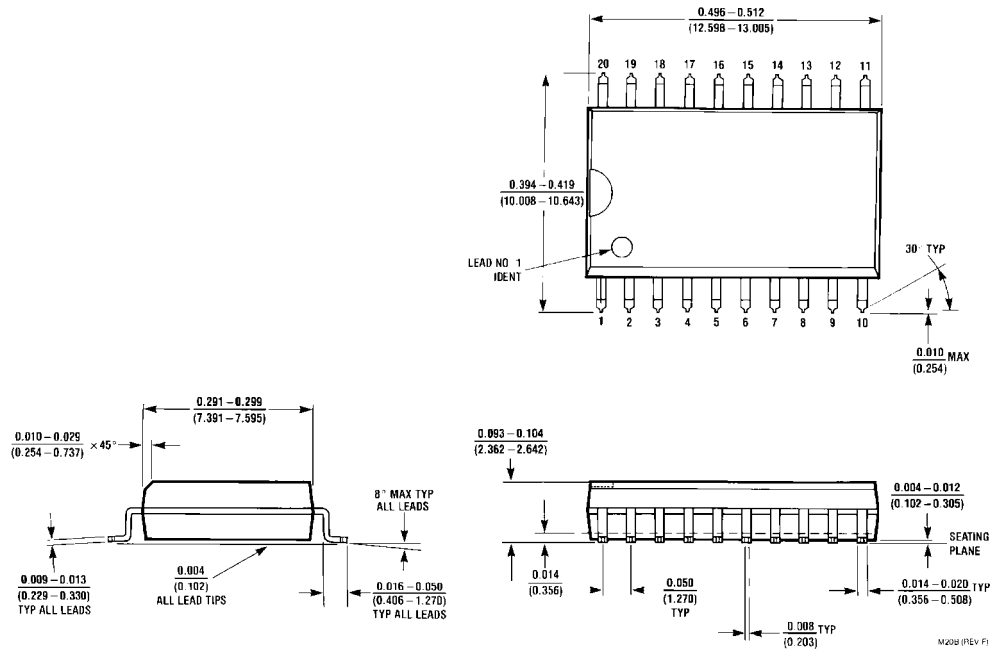

**20-Lead Small Outline Integrated Circuit (SOIC), JEDEC MS-013, 0.300" Wide
Package Number M20B**

Physical Dimensions inches (millimeters) unless otherwise noted (Continued)

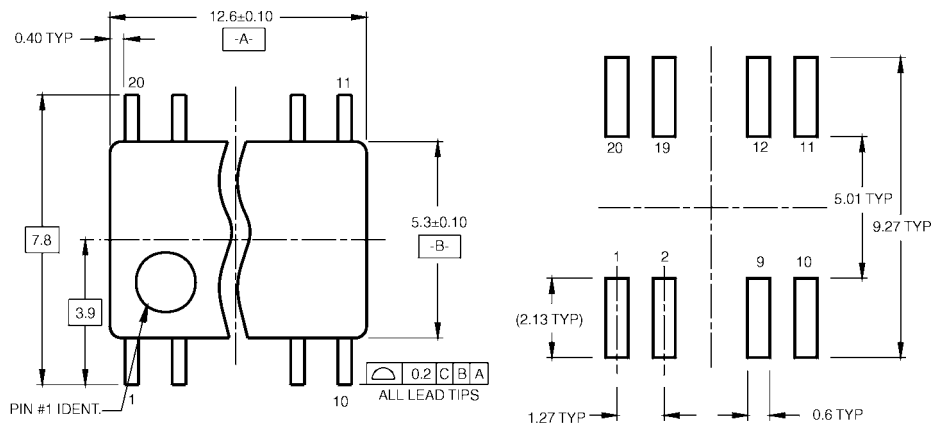

LAND PATTERN RECOMMENDATION

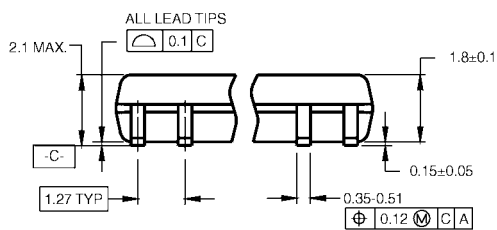

DIMENSIONS ARE IN MILLIMETERS

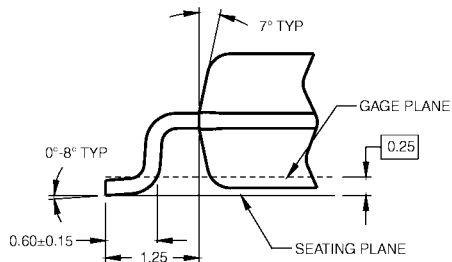
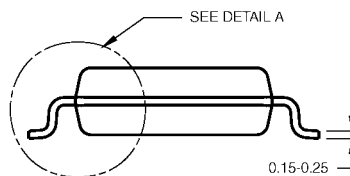

DETAIL A

- NOTES:
- A. CONFORMS TO EIAJ EDR-7320 REGISTRATION, ESTABLISHED IN DECEMBER, 1998.
 - B. DIMENSIONS ARE IN MILLIMETERS.
 - C. DIMENSIONS ARE EXCLUSIVE OF BURRS, MOLD FLASH, AND TIE BAR EXTRUSIONS.

M20DRevB1

**Pb-Free 20-Lead Small Outline Package (SOP), EIAJ TYPE II, 5.3mm Wide
Package Number M20D**

Physical Dimensions inches (millimeters) unless otherwise noted (Continued)

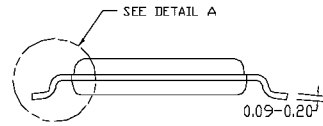
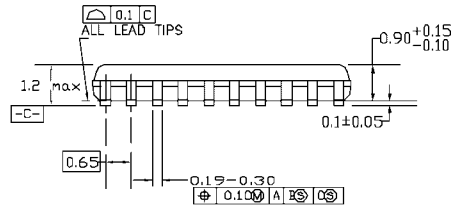
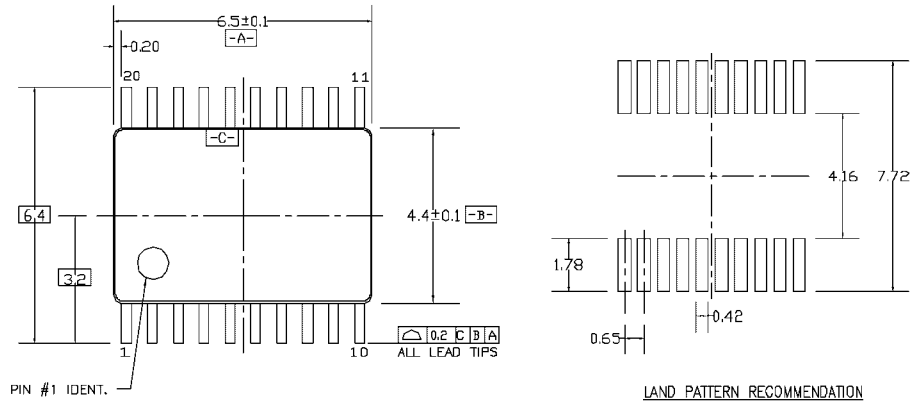

DIMENSIONS ARE IN MILLIMETERS

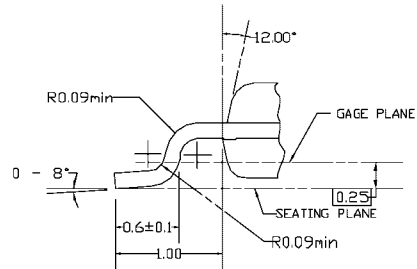

DETAIL A

NOTES:

- A. CONFORMS TO JEDEC REGISTRATION MO-153, VARIATION AC, REF NOTE 6, DATE 7/93.
- B. DIMENSIONS ARE IN MILLIMETERS.
- C. DIMENSIONS ARE EXCLUSIVE OF BURRS, MOLDS FLASH, AND TIE BAR EXTRUSIONS.
- D. DIMENSIONS AND TOLERANCES PER ANSI Y14.5M, 1982.

MTC20REV D1

**20-Lead Thin Shrink Small Outline Package (TSSOP), JEDEC MO-153, 4.4mm Wide
Package Number MTC20**

Physical Dimensions inches (millimeters) unless otherwise noted (Continued)

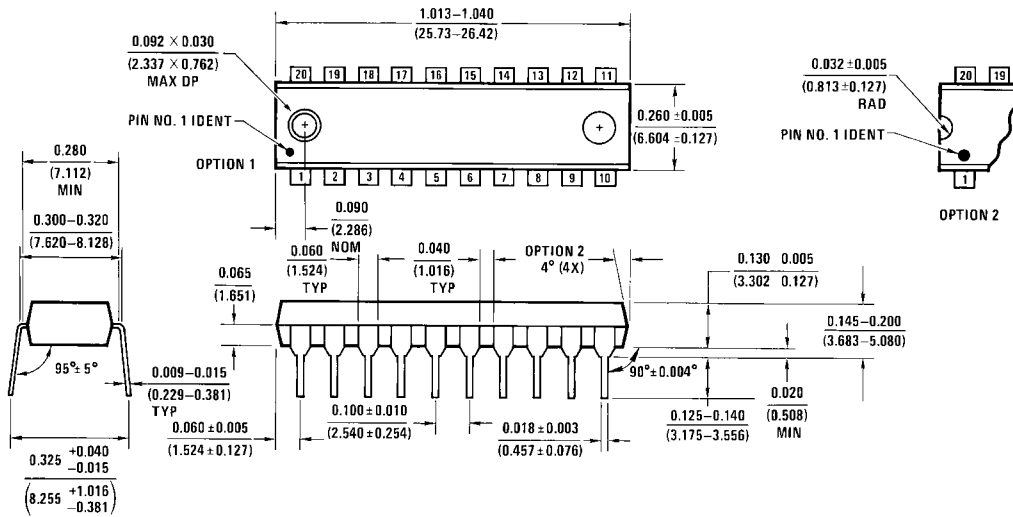

**20-Lead Plastic Dual-In-Line Package (PDIP), JEDEC MS-001, 0.300" Wide
Package Number N20A**

Fairchild does not assume any responsibility for use of any circuitry described, no circuit patent licenses are implied and Fairchild reserves the right at any time without notice to change said circuitry and specifications.

LIFE SUPPORT POLICY

FAIRCHILD'S PRODUCTS ARE NOT AUTHORIZED FOR USE AS CRITICAL COMPONENTS IN LIFE SUPPORT DEVICES OR SYSTEMS WITHOUT THE EXPRESS WRITTEN APPROVAL OF THE PRESIDENT OF FAIRCHILD SEMICONDUCTOR CORPORATION. As used herein:

1. Life support devices or systems are devices or systems which, (a) are intended for surgical implant into the body, or (b) support or sustain life, and (c) whose failure to perform when properly used in accordance with instructions for use provided in the labeling, can be reasonably expected to result in a significant injury to the user.
2. A critical component in any component of a life support device or system whose failure to perform can be reasonably expected to cause the failure of the life support device or system, or to affect its safety or effectiveness.

www.fairchildsemi.com