

## Aluminum Capacitors

### Axial High Temperature, DIN-Based

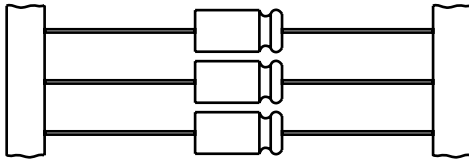
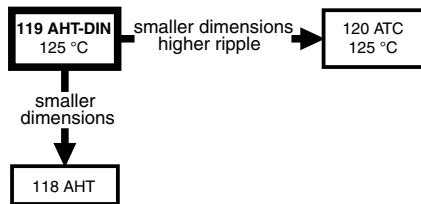

Fig.1 Component outlines

**RoHS**  
COMPLIANT

#### FEATURES

- Polarized aluminum electrolytic capacitors, non-solid electrolyte
- Axial leads, cylindrical aluminum case, insulated with a blue sleeve
- Mounting ring version not available in insulated form
- Taped versions up to case  $\varnothing$  15 x 30 mm available for automatic insertion
- Charge and discharge proof
- Extra long useful life: up to 8000 hours at 125 °C, high stability, high reliability
- Extended temperature range: 125 °C (usable up to 150 °C)
- High ripple current capability
- Lead (Pb)-free versions are RoHS compliant

#### APPLICATIONS

- Military, industrial control, EDP and telecommunication
- Smoothing, filtering, buffering in SMPS; coupling, decoupling
- For use where low mounting height is important; vibration and shock resistant

#### MARKING

The capacitors are marked (where possible) with the following information:

- Rated capacitance (in  $\mu\text{F}$ )
- Tolerance on rated capacitance, code letter in accordance with IEC 60062 (T for - 10 to + 50 %)
- Rated voltage (in V) at 125 °C and 85 °C
- Date code, in accordance with IEC 60062
- Code for factory of origin
- Name of manufacturer
- Band to indicate the negative terminal
- '+' sign to identify the positive terminal
- Series number (119)

#### QUICK REFERENCE DATA

DESCRIPTION	VALUE	
Nominal case sizes ( $\varnothing$ D x L in mm)	6.5 x 18 to 10 x 25	10 x 30 to 21 x 38
Rated capacitance range, $C_R$	4.7 to 4700 $\mu\text{F}$	
Tolerance on $C_R$	- 10/+ 50 %	
Rated voltage range, $U_R$	10 to 200 V	
Category temperature range	- 55 to + 125 °C	
Endurance test at 150 °C	500 hours	500 hours
Endurance test at 125 °C	2000 hours	4000 hours
Useful life at 125 °C	4000 hours	8000 hours
Useful life at 40 °C, 1.8 $I_R$ applied	500 000 hours	100 0000 hours
Shelf life at 0 V, 125 °C: $U_R = 10$ to 63 V $U_R = 100$ and 200 V	500 hours 100 hours	
Based on sectional specification	IEC 60384-4/EN130300	
Climatic category IEC 60068	55/125/56	

#### SELECTION CHART FOR $C_R$ , $U_R$ AND RELEVANT NOMINAL CASE SIZES ( $\varnothing$ D x L in mm)

$C_R$ ( $\mu\text{F}$ )	$U_R$ (V)						
	10	16	25	40	63	100	200
4.7	-	-	-	-	-	6.5 x 18	10 x 18
10	-	-	-	-	6.5 x 18	8 x 18	10 x 25
22	-	-	6.5 x 18	-	8 x 18	10 x 18	-
47	-	6.5 x 18	-	8 x 18	10 x 18	10 x 25	-
	-	-	-	-	-	10 x 30	-
68	-	-	-	-	10 x 30	12.5 x 30	-
100	6.5 x 18	8 x 18	10 x 18	10 x 25	10 x 30	15 x 30	-
150	-	-	-	12.5 x 30	15 x 30	15 x 30	-

<b>SELECTION CHART FOR C<sub>R</sub>, U<sub>R</sub> AND RELEVANT NOMINAL CASE SIZES (∅ D x L in mm)</b>							
C <sub>R</sub> (μF)	U <sub>R</sub> (V)						
	10	16	25	40	63	100	200
220	10 x 18	10 x 25	10 x 25	12.5 x 30	15 x 30	18 x 30	-
	-	-	12.5 x 30	-	-	-	-
330	-	12.5 x 30	12.5 x 30	15 x 30	18 x 30	18 x 38	-
470	10 x 25	12.5 x 30	12.5 x 30	15 x 30	18 x 38	21 x 38	-
	12.5 x 30	-	-	-	-	-	-
680	12.5 x 30	15 x 30	18 x 30	18 x 30	21 x 38	-	-
1000	15 x 30	15 x 30	18 x 30	18 x 38	21 x 38	-	-
1500	18 x 30	18 x 30	18 x 38	21 x 38	-	-	-
2200	18 x 30	18 x 38	21 x 38	21 x 38	-	-	-
3300	18 x 38	21 x 38	-	-	-	-	-
4700	21 x 38	21 x 38	-	-	-	-	-

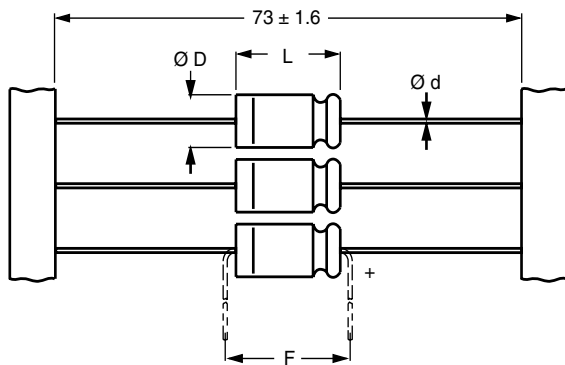
**DIMENSIONS IN MILLIMETERS AND AVAILABLE FORMS**

**Form BR:** Taped on reel  
 case ∅ D x L = 6.5 x 18 to 15 x 30 mm  
**Form BA:** Taped in box (ammopack)  
 case ∅ D x L = 6.5 x 18 to 10 x 25 mm

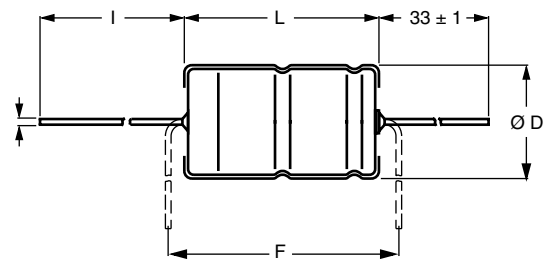
**Fig.2 Forms BA and BR**

**Form AA:** Axial in box  
 case ∅ D x L = 10 x 30 to 21 x 38 mm

**Fig.3 Form AA**
**Table 1**

<b>AXIAL; DIMENSIONS in millimeters, MASS AND PACKAGING QUANTITIES</b>										
NOMINAL CASE SIZE ∅ D x L	CASE CODE	AXIAL FORM AA, BA, and BR					MASS (g)	PACKAGING QUANTITIES		
		∅ d	l	∅ D <sub>max.</sub>	L <sub>max.</sub>	F <sub>min.</sub>		FORM AA	FORM BA	FORM BR
6.5 x 18	4	0.8	-	6.9	18.5	25	≈ 1.3	-	1000	1000
8 x 18	5	0.8	-	8.5	18.5	25	≈ 1.7	-	500	500
10 x 18	6	0.8	-	10.5	18.5	25	≈ 2.5	-	500	500
10 x 25	7	0.8	-	10.5	25.5	30	≈ 3.3	-	500	500
10 x 30	00	0.8	55 ± 1	10.5	30.5	35	≈ 4.8	340	-	500
12.5 x 30	01	0.8	55 ± 1	13.0	30.5	35	≈ 7.4	260	-	400
15 x 30	02	0.8	55 ± 1	15.5	30.5	35	≈ 11.7	200	-	250
18 x 30	03	0.8	55 ± 1	18.5	30.5	35	≈ 12.9	120	-	-
18 x 38	04	0.8	34 ± 1	18.5	39.5	44	≈ 19.0	125	-	-
21 x 38	05	0.8	34 ± 1	21.5	39.5	44	≈ 24.0	100	-	-

**Note**

Detailed tape dimensions see section 'PACKAGING'.

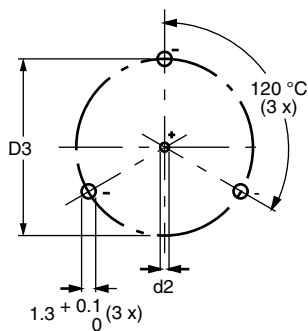

Mounting holes

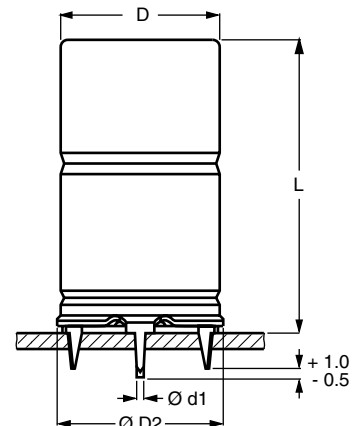
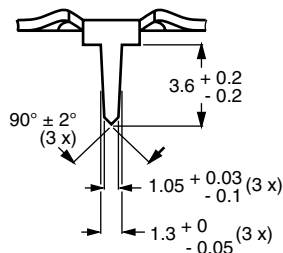

Case  $\varnothing$  D x L = 15 x 30 to 21 x 38 mm  
Case not insulated (insulation on request)  
Especially for applications with severe shocks and vibrations

Fig.4 Mounting hole digram and outline; **Form MR:** With mounting ring and pins

Table 2

<b>MOUNTING RING; DIMENSIONS</b> in millimeters, <b>MASS AND PACKAGING QUANTITIES</b>									
NOMINAL CASE SIZE $\varnothing$ D x L	CASE CODE	MOUNTING RING: FORM MR						MASS (g)	PACKAGING QUANTITIES
		$\varnothing$ d1	$\varnothing$ d2	$\varnothing$ D <sub>max.</sub>	$\varnothing$ . D2 <sub>max</sub>	D3	L <sub>max.</sub>		
15 x 30	02	0.8	1.0 + 0.4	15.5	17.5	16.5 ± 0.2	33	≈ 8.6	200
18 x 30	03	0.8	1.0 + 0.4	18.5	19.5	18.5 ± 0.2	33	≈ 11.5	240
18 x 38	04	0.8	1.0 + 0.4	18.5	19.5	18.5 ± 0.2	42	≈ 14.0	100
21 x 38	05	0.8	1.0 + 0.4	21.5	22.5	21.5 ± 0.2	42	≈ 19.2	100

<b>ELECTRICAL DATA</b>	
SYMBOL	DESCRIPTION
$C_R$	rated capacitance at 100 Hz, tolerance - 10/+ 50 %
$I_R$	rated RMS ripple current at 100 Hz, 125 °C
$I_{L1}$	max. leakage current after 1 minute at $U_R$
$I_{L5}$	max. leakage current after 5 minutes at $U_R$
$\tan \delta$	max. dissipation factor at 100 Hz
ESR	equivalent series resistance at 100 Hz (calculated from $\tan \delta_{max.}$ and $C_R$ )
Z	max. impedance at 10 kHz

**Note**

Unless otherwise specified, all electrical values in Table 2 apply at  $T_{amb} = 20$  °C, P = 86 to 106 kPa, RH = 45 to 75 %.

**ORDERING EXAMPLE**

Electrolytic capacitor 119 series  
470  $\mu$ F/16 V; - 10/+ 50 %  
Nominal case size:  $\varnothing$  12.5 x 30 mm; Form BR  
Ordering code: MAL211925471E3  
Former 12NC: 2222 119 25471



Aluminum Capacitors  
Axial High Temperature, DIN-Based

Vishay BCcomponents

Table 2

ELECTRICAL DATA AND ORDERING INFORMATION													
U <sub>R</sub> (V)	C <sub>R</sub> 100 Hz (μF)	NOMINAL CASE SIZE Ø D x L (mm)	CASE CODE	I <sub>R</sub> 100 Hz 125 °C (mA)	I <sub>L1</sub> 1 min (μA)	I <sub>L5</sub> 5 min (μA)	Tan δ 100 Hz	ESR 100 Hz (Ω)	Z 10 kHz (Ω)	ORDERING CODE MAL2119.....			
										IN BOX FORM AA	TAPED ON REEL FORM BR	TAPED IN BOX FORM BA	MOUNTING RING FORM MR
10	100	6.5 x 18	4	130	10	6	0.2	3.5	2.2	-	24101E3	34101E3	-
	220	10 x 18	6	240	17	8.4	0.18	1.3	1.0	-	24221E3	34221E3	-
	470	10 x 25	7	380	32	13	0.18	0.61	0.49	-	90501E3	90502E3	-
	470	12.5 x 30	01	550	32	13	0.16	0.54	0.38	14471E3	24471E3	-	-
	680	12.5 x 30	01	640	45	18	0.20	0.47	0.38	14681E3	24681E3	-	-
	1000	15 x 30	02	830	64	24	0.20	0.32	0.24	90032E3	24102E3	-	44102E3
	1500	18 x 30	03	1100	94	34	0.22	0.23	0.17	14152E3	-	-	44152E3
	2200	18 x 30	03	1190	136	48	0.26	0.19	0.17	14222E3	-	-	44222E3
	3300	18 x 38	04	1550	202	70	0.27	0.13	0.10	14332E3	-	-	44332E3
	4700	21 x 38	05	1700	286	90	0.30	0.10	0.09	14472E3	-	-	44472E3
16	47	6.5 x 18	4	110	10	5.5	0.13	4.4	2.2	-	25479E3	35479E3	-
	100	8 x 18	5	170	14	7.2	0.13	2.1	1.3	-	25101E3	35101E3	-
	220	10 x 25	7	300	25	11	0.13	0.94	0.55	-	25221E3	35221E3	-
	330	12.5 x 30	01	560	36	15	0.13	0.63	0.38	15331E3	25331E3	-	-
	470	12.5 x 30	01	570	50	19	0.15	0.51	0.38	15471E3	25471E3	-	-
	680	15 x 30	02	750	69	26	0.15	0.35	0.24	15681E3	25681E3	-	45681E3
	1000	15 x 30	02	850	100	36	0.19	0.30	0.24	15102E3	25102E3	-	45102E3
	1500	18 x 30	03	1120	148	52	0.20	0.21	0.17	15152E3	-	-	45152E3
	2200	18 x 38	04	1440	215	74	0.20	0.14	0.10	15222E3	-	-	45222E3
	3300	21 x 38	05	1650	321	110	0.22	0.11	0.09	15332E3	-	-	45332E3
4700	21 x 38	05	1710	455	154	0.28	0.09	0.09	15472E3	-	-	45472E3	
25	22	6.5 x 18	4	85	10	5.1	0.10	7.2	3.2	-	26229E3	36229E3	-
	100	10 x 18	6	210	19	9	0.10	1.6	1.0	-	26101E3	36101E3	-
	220	10 x 25	7	350	37	15	0.10	0.72	0.58	-	90503E3	90504E3	-
	220	12.5 x 30	01	500	37	15	0.09	0.65	0.38	16221E3	26221E3	-	-
	330	12.5 x 30	01	580	54	21	0.11	0.53	0.38	16331E3	26331E3	-	-
	470	12.5 x 30	01	630	75	28	0.13	0.44	0.38	16471E3	26471E3	-	-
	680	18 x 30	03	990	106	38	0.13	0.30	0.17	16681E3	-	-	46681E3
	1000	18 x 30	03	1090	154	54	0.13	0.21	0.17	16102E3	-	-	46102E3
	1500	18 x 38	04	1420	229	79	0.13	0.14	0.10	16152E3	-	-	46152E3
	2200	21 x 38	05	1550	334	114	0.13	0.11	0.09	16222E3	-	-	46222E3
40	47	8 x 18	5	150	15	7.8	0.08	2.7	1.5	-	27479E3	37479E3	-
	100	10 x 25	7	260	28	12	0.08	1.3	0.7	-	27101E3	37101E3	-
	150	12.5 x 30	01	440	40	16	0.08	0.85	0.51	17151E3	27151E3	-	-
	220	12.5 x 30	01	500	57	22	0.09	0.65	0.48	17221E3	27221E3	-	-
	330	15 x 30	02	630	83	30	0.09	0.43	0.37	17331E3	27331E3	-	47331E3
	470	15 x 30	02	720	117	42	0.12	0.41	0.37	17471E3	27471E3	-	47471E3
	680	18 x 30	03	970	167	58	0.12	0.28	0.22	17681E3	-	-	47681E3
	1000	18 x 38	04	1250	244	84	0.12	0.19	0.14	17102E3	-	-	47102E3
	1500	21 x 38	05	1410	364	124	0.14	0.15	0.12	17152E3	-	-	47152E3
	2200	21 x 38	05	1550	532	180	0.18	0.13	0.11	17222E3	-	-	47222E3

ELECTRICAL DATA AND ORDERING INFORMATION													
U <sub>R</sub> (V)	C <sub>R</sub> 100 Hz (μF)	NOMINAL CASE SIZE Ø D x L (mm)	CASE CODE	I <sub>R</sub> 100 Hz 125 °C (mA)	I <sub>L1</sub> 1 min (μA)	I <sub>L5</sub> 5 min (μA)	Tan δ 100 Hz	ESR 100 Hz (Ω)	Z 10 kHz (Ω)	ORDERING CODE MAL2119.....			
										IN BOX FORM AA	TAPED ON REEL FORM BR	TAPED IN BOX FORM BA	MOUNTING RING FORM MR
63	10	6.5 x 18	4	68	20	5.3	0.07	11	5.6	-	28109E3	38109E3	-
	22	8 x 18	5	110	20	6.7	0.07	5.1	2.8	-	28229E3	38229E3	-
	47	10 x 18	6	180	22	9.9	0.07	2.4	1.3	-	28479E3	38479E3	-
	68	10 x 25	7	230	30	13	0.07	1.6	1.0	-	90505E3	90506E3	-
	68	10 x 30	00	300	30	13	0.07	1.6	0.92	18689E3	28689E3	-	-
	100	10 x 30	00	360	42	17	0.08	1.3	0.75	18101E3	28101E3	-	-
	150	15 x 30	02	560	61	23	0.08	0.85	0.37	18151E3	28151E3	-	48151E3
	220	15 x 30	02	640	87	32	0.08	0.58	0.37	18221E3	28221E3	-	48221E3
	330	18 x 30	03	880	129	46	0.09	0.43	0.23	18331E3	-	-	48331E3
	470	18 x 38	04	1130	182	63	0.09	0.30	0.15	18471E3	-	-	48471E3
	680	21 x 38	05	1290	261	90	0.09	0.21	0.12	18681E3	-	-	48681E3
1000	21 x 38	05	1430	382	130	0.10	0.16	0.11	18102E3	-	-	48102E3	
100	4.7	6.5 x 18	4	44	20	10	0.08	27	10	-	29478E3	39478E3	-
	10	8 x 18	5	70	20	10	0.08	13	6.0	-	29109E3	39109E3	-
	22	10 x 18	6	112	20	10	0.08	5.8	3.5	-	29229E3	39229E3	-
	47	10 x 25	7	178	32	13	0.08	2.7	2.0	-	90518E3	90519E3	-
	47	10 x 30	00	240	32	13	0.08	2.7	2.0	19479E3	29479E3	-	-
	68	12.5 x 30	01	330	45	18	0.08	1.9	1.2	19689E3	29689E3	-	-
	100	15 x 30	02	440	64	24	0.09	1.4	0.96	19101E3	29101E3	-	49101E3
	150	15 x 30	02	520	94	34	0.10	1.1	0.78	19151E3	29151E3	-	49151E3
	220	18 x 30	03	710	136	48	0.10	0.72	0.55	19221E3	-	-	49221E3
	330	18 x 38	04	920	202	70	0.10	0.48	0.37	19331E3	-	-	49331E3
470	21 x 38	05	1070	286	98	0.10	0.34	0.28	19471E3	-	-	49471E3	
200	4.7	10 x 18	6	52	20	10	0.08	27	10	-	90507E3	90508E3	-
	10	10 x 25	7	82	20	10	0.08	13	5.0	-	90509E3	90511E3	-

ADDITIONAL ELECTRICAL DATA			
PARAMETER	CONDITIONS	VALUE	
		AXIAL	MOUNTING RING
<b>Voltage</b>			
Surge voltage		$U_s \leq 1.15 \times U_R$	
Reverse voltage		$U_{rev} \leq 1 \text{ V}$	
<b>Current</b>			
Leakage current	After 1 minute: $U_R = 10 \text{ to } 40 \text{ V}$  $U_R = 63 \text{ V to } 200 \text{ V}$	$I_{L1} \leq 0.006 C_R \times U_R + 4 \mu\text{A}$ , or $10 \mu\text{A}$ (whichever is greater)  $I_{L1} \leq 0.006 C_R \times U_R + 4 \mu\text{A}$ , or $20 \mu\text{A}$ (whichever is greater)	
	After 5 minutes: $U_R = 10 \text{ to } 63 \text{ V}$ $U_R = 100 \text{ and } 200 \text{ V}$	$I_{L5} \leq 0.002 C_R \times U_R + 4 \mu\text{A}$  $I_{L5} \leq 0.002 C_R \times U_R + 4 \mu\text{A}$ , or $10 \mu\text{A}$ (whichever is greater)	
<b>Inductance</b>			



ADDITIONAL ELECTRICAL DATA			
PARAMETER	CONDITIONS	VALUE	
		AXIAL	MOUNTING RING
Equivalent series inductance (ESL)	Case Ø D x L mm:		
	6.5 x 18	typ. 15 nH	-
	8 x 18	typ. 35 nH	-
	10 x 18	typ. 69 nH	-
	10 x 25	typ. 38 nH	-
	10 x 30	typ. 38 nH	-
	12.5 x 30	typ. 46 nH	-
	15 x 30	typ. 48 nH	typ. 39 nH
	18 x 30	typ. 50 nH	typ. 39 nH
	18 x 38	typ. 54 nH	typ. 39 nH
21 x 38	typ. 59 nH	typ. 39 nH	

Table 3

UPRATING VALUES AT REDUCED AMBIENT TEMPERATURE									
SYMBOL	CONDITIONS	VALUES							UNIT
$U_R$	$T_{amb} > 85 \text{ }^\circ\text{C}$	10	16	25	40	63	100	200	V
$U_{R2}$	$T_{amb} \leq 85 \text{ }^\circ\text{C}$	16	25	40	63	100	125	250	V

**Note**

- For applications at ambient temperatures of  $\leq 85 \text{ }^\circ\text{C}$ , the rated voltage ( $U_R$ ) may be raised to  $U_{R2}$ .

**CAPACITANCE (C)**

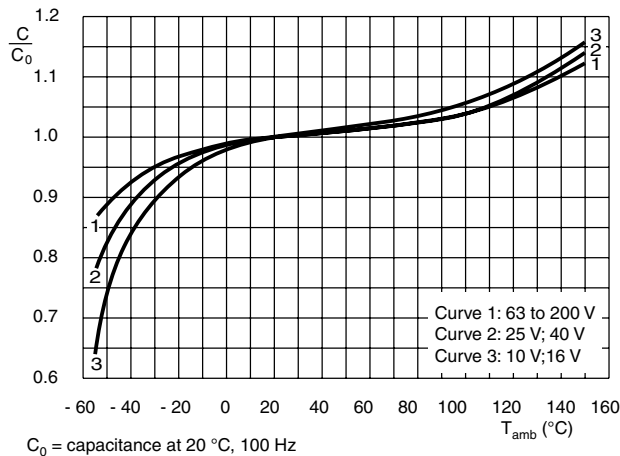

Fig.5 Typical multiplier of capacitance as a function of ambient temperature

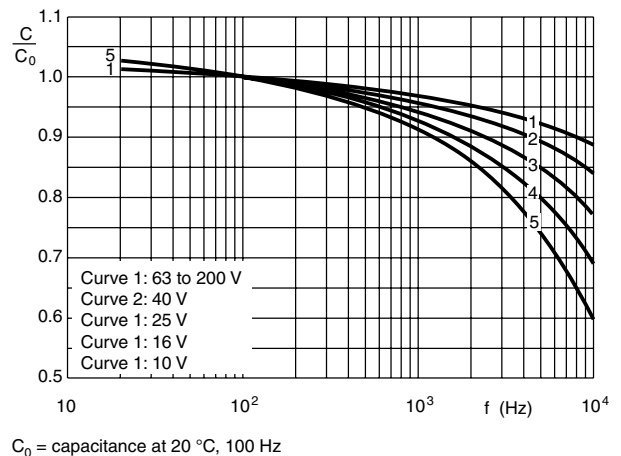
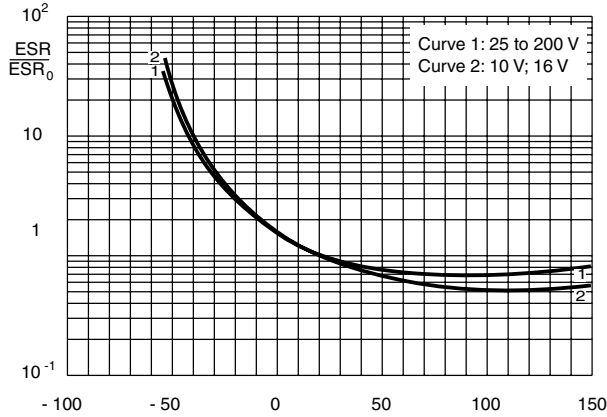

Fig.6 Typical multiplier of capacitance as a function of ambient temperature



**EQUIVALENT SERIES RESISTANCE (ESR)**



Case Ø D x L = 6.5 x 18 to 15 x 30 mm  
ESR<sub>0</sub> = typical at 20 °C, 100 Hz

Fig.7 Typical multiplier of ESR as a function of ambient temperature

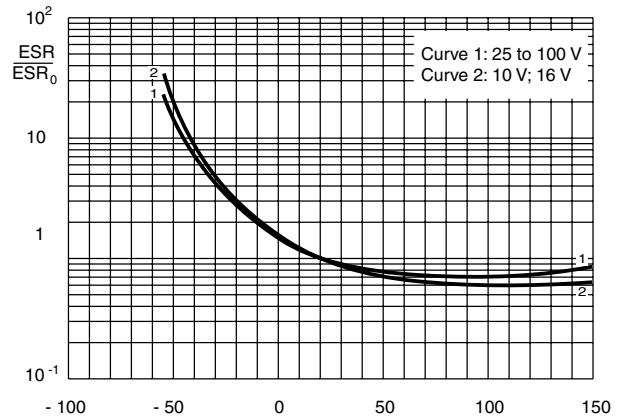

Case Ø D x L = 18 x 30 to 21 x 38 mm  
ESR<sub>0</sub> = typical at 20 °C, 100 Hz

Fig.8 Typical multiplier of ESR as a function of ambient temperature

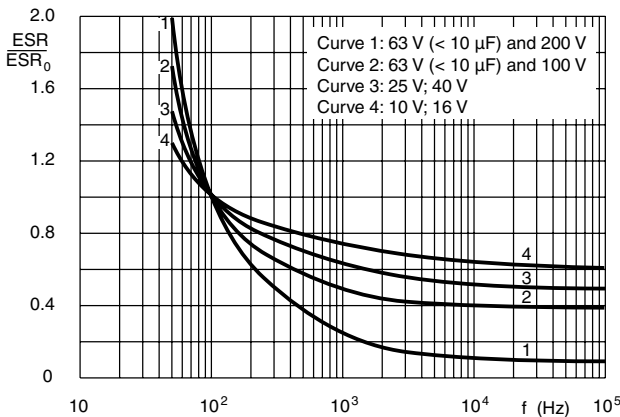

Case Ø D x L = 6.5 x 18 to 10 x 25 mm  
ESR<sub>0</sub> = typical at 20 °C, 100 Hz

Fig.9 Typical multiplier of ESR as a function of frequency

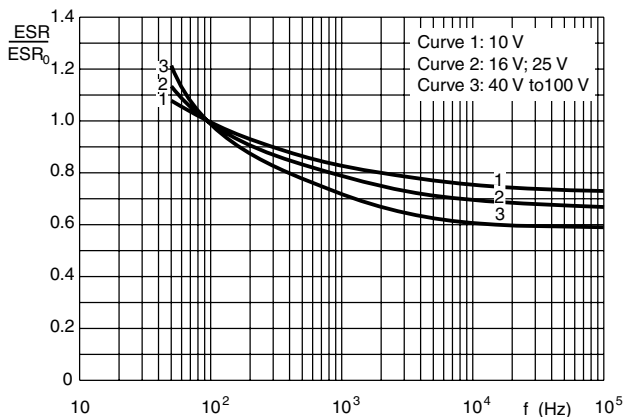

Case Ø D x L = 10 x 30 to 21 x 38 mm  
ESR<sub>0</sub> = typical at 20 °C, 100 Hz

Fig.10 Typical multiplier of ESR as a function of frequency

**IMPEDANCE (Z)**

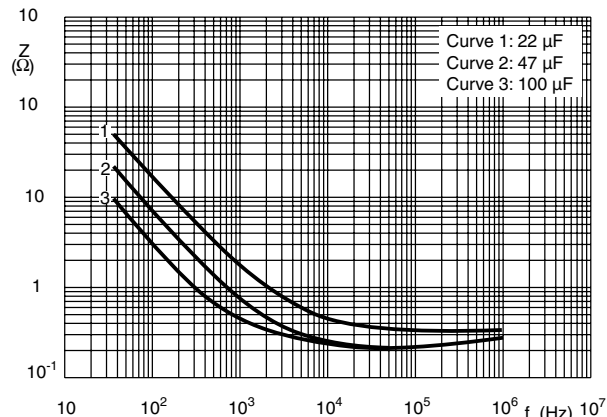

Case Ø D x L = 8 x 18 mm

Fig.11 Typical impedance as a function of frequency

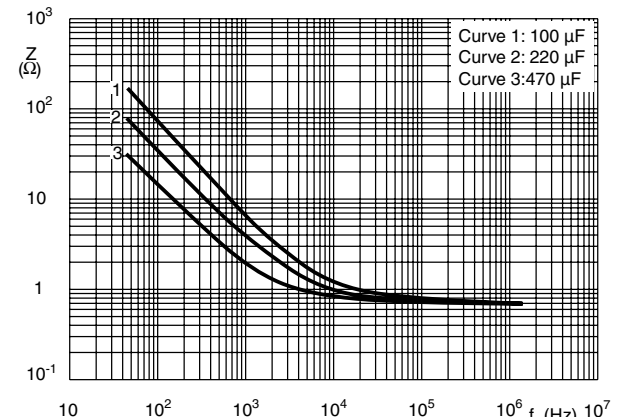

Case Ø D x L = 8 x 18 mm

Fig.12 Typical impedance as a function of frequency



**IMPEDANCE (Z)**

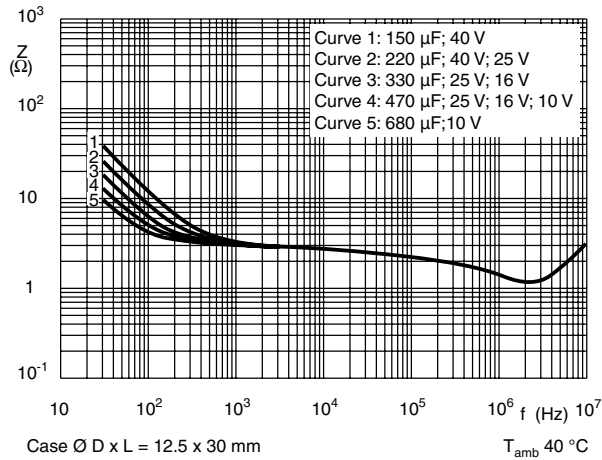

Fig.13 Typical impedance as a function of frequency

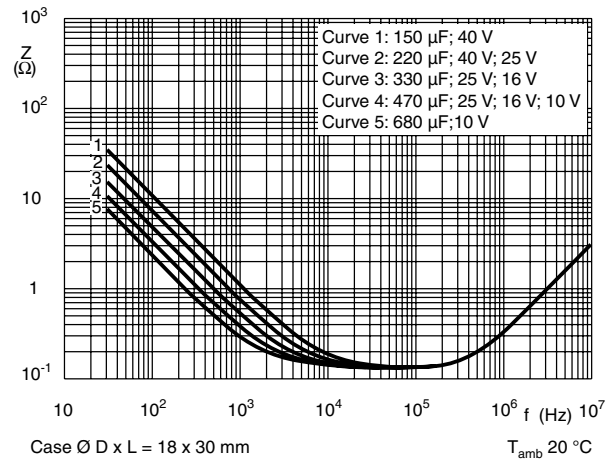

Fig.14 Typical impedance as a function of frequency

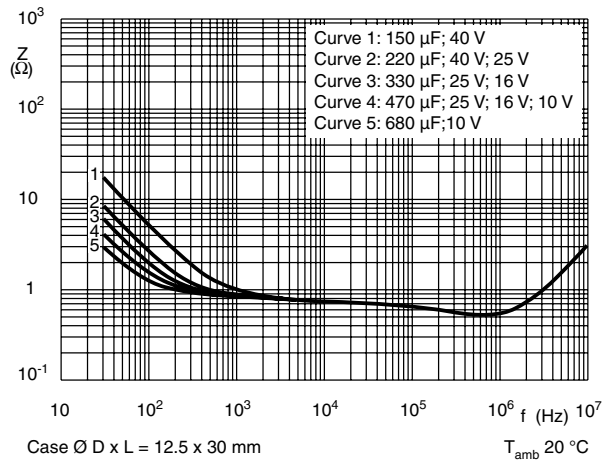

Fig.15 Typical impedance as a function of frequency

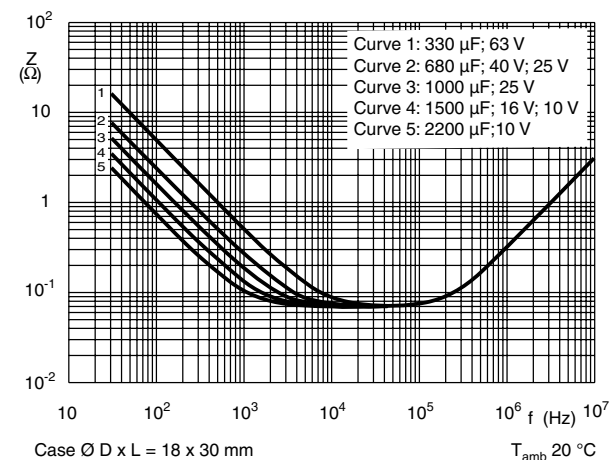

Fig.16 Typical impedance as a function of frequency





**RIPPLE CURRENT AND USEFUL LIFE**

MBC242

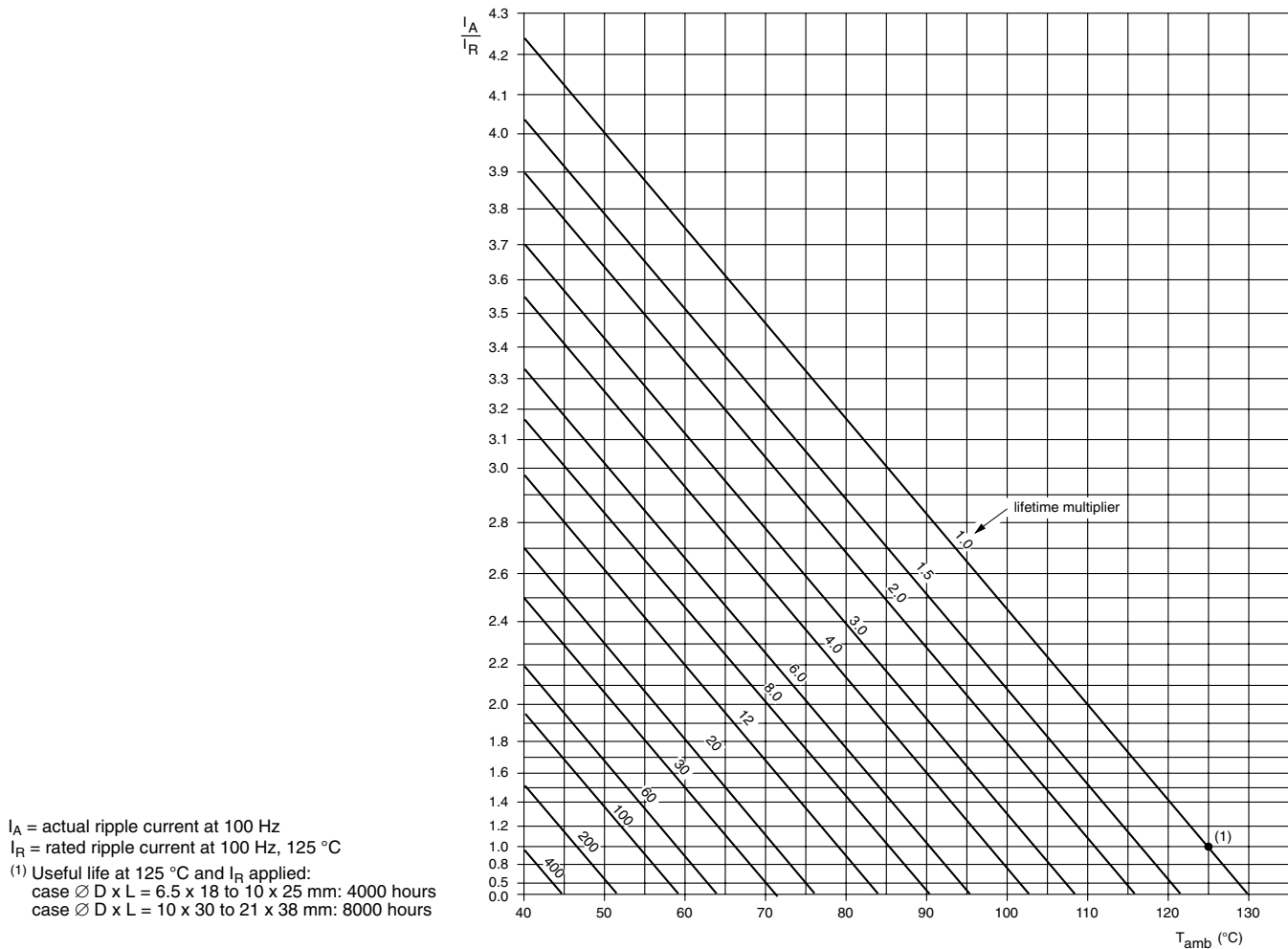

Fig.17 Multiplier of useful life as a function of ambient temperature and ripple current load

Table 4

MULTIPLIER OF RIPPLE CURRENT ( $I_R$ ) AS A FUNCTION OF FREQUENCY			
FREQUENCY (Hz)	$I_R$ MULTIPLIER		
	$U_R = 10$ and $16$ V	$U_R = 25$ and $40$ V	$U_R = 63$ to $200$ V
50	0.95	0.90	0.85
100	1.00	1.00	1.00
300	1.07	1.12	1.20
1000	1.12	1.20	1.30
3000	1.15	1.25	1.35
$\geq 10\ 000$	1.20	1.30	1.40



Aluminum Capacitors  
Axial High Temperature, DIN-Based

Vishay BCcomponents

Table 5

TEST PROCEDURES AND REQUIREMENTS			
TEST		PROCEDURE (quick reference)	REQUIREMENTS
NAME OF TEST	REFERENCE		
Endurance	IEC 60384-4/ EN130300 subclause 4.13	$T_{amb} = 125\text{ }^{\circ}\text{C}$ ; $U_R$ applied; Case $\varnothing D \times L = 6.5 \times 18$ to $10 \times 25$ mm: 2000 hours; Case $\varnothing D \times L = 10 \times 30$ to $21 \times 38$ mm: 4000 hours	$\Delta C/C: \pm 15\%$ $\tan \delta \leq 1.3 \times \text{spec. limit}$ $Z \leq 2 \times \text{spec. limit}$ $I_{L5} \leq \text{spec. limit}$
Useful life	CECC 30301 subclause 1.8.1	$T_{amb} = 125\text{ }^{\circ}\text{C}$ ; $U_R$ and $I_R$ applied; Case $\varnothing D \times L = 6.5 \times 18$ to $10 \times 25$ mm: 4000 hours; Case $\varnothing D \times L = 10 \times 30$ to $21 \times 38$ mm: 8000 hours	$\Delta C/C: \pm 45\%$ $\tan \delta \leq 3 \times \text{spec. limit}$ $Z \leq 3 \times \text{spec. limit}$ $I_{L5} \leq \text{spec. limit}$ no short or open circuit total failure percentage: $\leq 1\%$ ( $200\text{ V} \leq 3\%$ )
Shelf life (storage at high temperature)	IEC 60384-4/ EN130300 subclause 4.17	$T_{amb} = 125\text{ }^{\circ}\text{C}$ ; no voltage applied; $U_R = 10$ to $63\text{ V}$ : 500 hours; $U_R = 100$ and $200\text{ V}$ : 100 hours  After test: $U_R$ to be applied for 30 minutes, 24 to 48 hours before measurement	$\Delta C/C, \tan \delta, Z$ : for requirements see 'Endurance test' above  $I_{L5} \leq 2 \times \text{spec. limit}$
Reverse voltage	IEC 60384-4/ EN130300 subclause 4.15	$T_{amb} = 125\text{ }^{\circ}\text{C}$ : 125 hours at $U = -1\text{ V}$ followed by 125 hours at $U_R$	$\Delta C/C: \pm 20\%$ $\tan \delta \leq \text{spec. limit}$ $I_{L5} \leq \text{spec. limit}$



## Disclaimer

All product specifications and data are subject to change without notice.

Vishay Intertechnology, Inc., its affiliates, agents, and employees, and all persons acting on its or their behalf (collectively, "Vishay"), disclaim any and all liability for any errors, inaccuracies or incompleteness contained herein or in any other disclosure relating to any product.

Vishay disclaims any and all liability arising out of the use or application of any product described herein or of any information provided herein to the maximum extent permitted by law. The product specifications do not expand or otherwise modify Vishay's terms and conditions of purchase, including but not limited to the warranty expressed therein, which apply to these products.

No license, express or implied, by estoppel or otherwise, to any intellectual property rights is granted by this document or by any conduct of Vishay.

The products shown herein are not designed for use in medical, life-saving, or life-sustaining applications unless otherwise expressly indicated. Customers using or selling Vishay products not expressly indicated for use in such applications do so entirely at their own risk and agree to fully indemnify Vishay for any damages arising or resulting from such use or sale. Please contact authorized Vishay personnel to obtain written terms and conditions regarding products designed for such applications.

Product names and markings noted herein may be trademarks of their respective owners.