

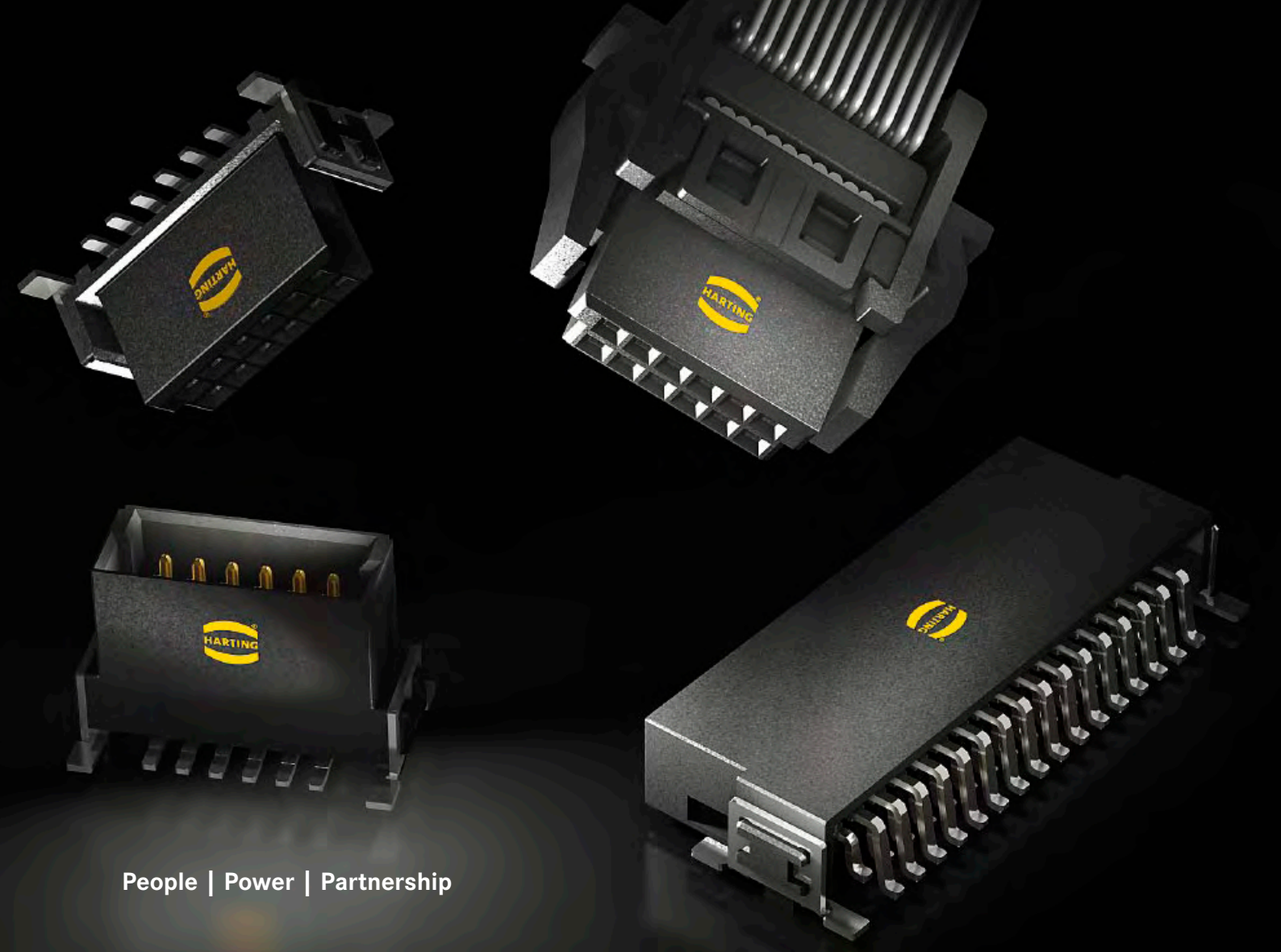

Pushing Performance

HARTING *har-flex*® connectors



Transforming customer wishes into concrete solutions



The HARTING Technology Group is skilled in the fields of electrical, electronic and optical connection, transmission and networking, as well as in manufacturing, mechatronics and software creation. The Group uses these skills to develop customized solutions and products such as connectors for energy and data transmission applications including, for example, mechanical engineering, rail technology, wind energy plants, factory automation and the telecommunications sector. In addition, HARTING also produces electro-magnetic components for the automobile industry and offers solutions in the field of Enclosures and Shop Systems.

The HARTING Group currently comprises 36 subsidiary companies and worldwide distributors employing a total of approx. 3,400 staff.

**We aspire to top performance.**

Connectors ensure functionality. As core elements of electrical and optical wiring, connection and infrastructure technologies, they are essential in enabling the modular construction of devices, machines and systems across a very wide range of industrial applications. Their reliability is a crucial factor guaranteeing smooth functioning in the manufacturing area, in telecommunications, applications in medical technology – in fact, connectors are at work in virtually every conceivable application area. Thanks to the consistent further development of our technologies, customers enjoy investment security and benefit from durable, long term functionality.

Always at hand, wherever our customers may be.

Increasing industrialization is creating growing markets characterized by widely diverging demands and requirements. The search for perfection, increasingly efficient processes and reliable technologies is a common factor in all sectors across the globe.

HARTING is providing these technologies – in Europe, America and Asia. The **HARTING** professionals at our international subsidiaries engage in close, partnership based interaction with our customers, right from the very early product development phases, in order to realize customer demands and requirements in the best possible manner.

Our people on location form the interface to the centrally coordinated development and production departments. In this way, our customers can rely on consistently high, superior product quality – worldwide.

Our claim: Pushing Performance.

HARTING provides more than optimally attuned components. In order to serve our customers with the best possible solutions, **HARTING** is able to contribute a great deal more and play a closely integrative role in the value creation process.

From ready assembled cables through to control racks or ready-to-go control desks: Our aim is to generate the maximum benefits for our customers – without compromise!

Quality creates reliability – and warrants trust.

The **HARTING** brand stands for superior quality and reliability – worldwide. The standards we set are the result of consistent, stringent quality management that is subject to regular certifications and audits.

EN ISO 9001, the EU Eco-Audit and ISO 14001:2004 are key elements here. We take a proactive stance to new requirements, which is why **HARTING** ranks among the first companies worldwide to have obtained the new IRIS quality certificate for rail vehicles.



HARTING technology creates added value for customers. Technologies by HARTING are at work worldwide. HARTING's presence stands for smoothly functioning systems, powered by intelligent connectors, smart infrastructure solutions and mature network systems. In the course of many years of close, trust-based cooperation with its customers, the HARTING Technology Group has advanced to one of the worldwide leading specialists for connector technology. Extending beyond the basic functionalities demanded, we offer individual customers specific and innovative solutions. These tailored solutions deliver sustained effects, provide investment security and enable customers to achieve strong added value.

Opting for HARTING opens up an innovative, complex world of concepts and ideas.

In order to develop connectivity and network solutions serving an exceptionally wide range of connector applications and task scopes in a professional and cost optimized manner, HARTING not only commands the full array of conventional tools and basic technologies. Over and beyond these capabilities, HARTING is constantly harnessing and refining its broad base of knowledge and experience to create new solutions that ensure continuity at the same time. In securing this know-how lead, HARTING draws on a wealth of sources from both in-house research and the world of applications alike.

Salient examples of these sources of innovative knowledge include microstructure technologies, 3D design and construction technology, as well as high temperature

or ultrahigh frequency applications that are finding use in telecommunications or automation networks, in the automotive industry, or in industrial sensor and actuator applications, RFID and wireless technologies, in addition to packaging and housing made of plastics, aluminum or stainless steel.

HARTING solutions extend across technology boundaries.

Drawing on the comprehensive resources of the group's technology pool, HARTING devises practical solutions for its customers. Whether this involves industrial networks for manufacturing automation, or hybrid interface solutions for wireless telecommunication infrastructures, 3D circuit carriers with microstructures, or cable assemblies for high-temperature applications in the automotive industry – HARTING technologies offer far more than components, and represent mature, comprehensive solutions attuned to individual customer requirements and wishes. The range covers ready-to-use cable configurations, completely assembled backplanes and board system carriers, as well as fully wired and tested control panels.

In order to ensure the future proof design of RF- and EMC-compatible interface solutions, the central HARTING laboratory (certified to EN 45001) provides simulation tools, as well as experimental, testing and diagnostics facilities all the way through to scanning electron microscopes. In the selection of materials and processes, lifecycle and environmental aspects play a key role, in addition to product and process capability considerations.



HARTING knowledge is practical know-how generating synergy effects.

HARTING commands decades of experience with regard to the applications conditions of connectors in telecommunications, computer and network technologies and medical technologies, as well as industrial automation technologies, such as the mechanical engineering and plant engineering areas, in addition to the power generation industry or the transportation sector. HARTING is highly conversant with the specific application areas in all of these technology fields.

The key focus is on applications in every solution approach. In this context, uncompromising, superior quality is our hallmark. Every new solution found will invariably flow back into the HARTING technology pool, thereby enriching our resources. And every new solution we go on to create will draw on this wealth of resources in order to optimize each and every individual solution. In this way, HARTING is synergy in action.

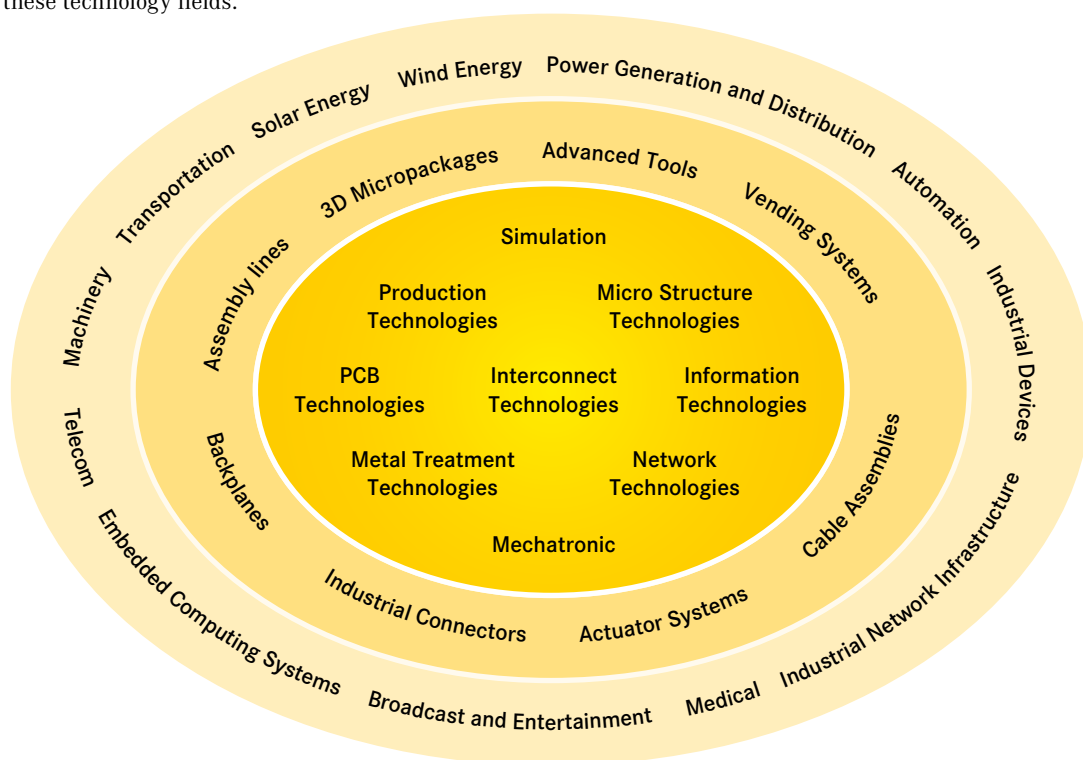

The **HARTING eCatalogue** is an electronic catalogue with a part configuration and 3D components library.

Here you can choose a connector according to your requirements. Afterwards you are able to send your inquiry directly to a HARTING sales partner.

The drawings to every single part are available in PDF-format.

The parts are downloadable in 2D-format (DXF) and 3D-format (IGES, STEP).

The 3D-models can be viewed with a VRML-viewer.

You can find the **HARTING eCatalogue** at www.HARTING.com.

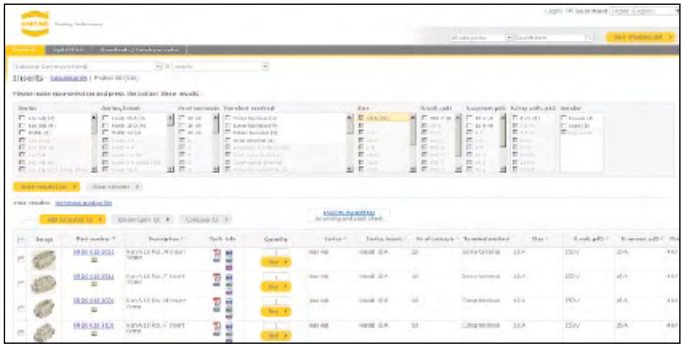

Product selection

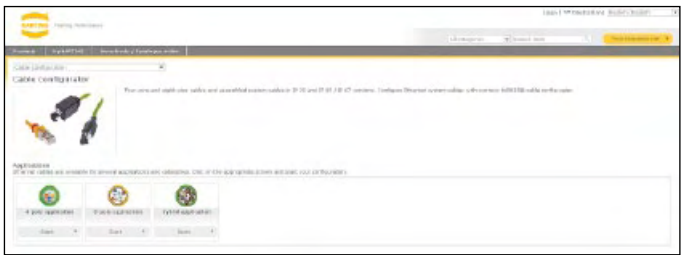

Product configuration

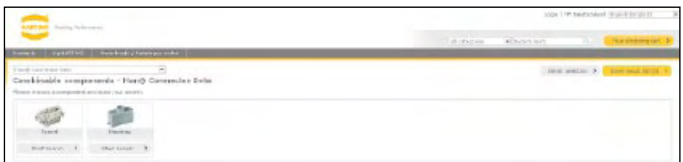

Product combination



Product overview

Product samples: Fast-track delivery to your desk, free of charge

The new free express sample service in the HARTING eCatalogue allows customers to order samples immediately, easily and completely free of charge. A broad selection from the device connectivity product portfolio is now available. If a product is unavailable, the system offers alternative products with similar features that can be requested at a mouse click.

The free samples are shipped within 48 hours at no cost to you. This service enables tremendous flexibility, especially in the design phase of projects.

General information





It is the customer's responsibility to check whether the components illustrated in this catalogue also comply with different regulations from those stated in special fields of applications.

We reserve the right to modify designs or substance of content in order to improve quality, keep pace with technological advancement or meet particular requirements in production.

No part of this catalogue may be reproduced in any form (print, photocopy, microfilm or any other process) or processed, duplicated or distributed by means of electronic systems without the prior written consent of HARTING Electronics GmbH & Co. KG, Espelkamp. We are bound by the German version only.

harflex® connectors

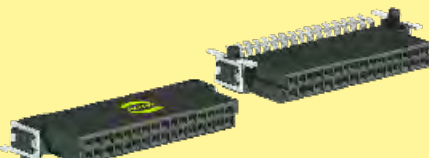
Page

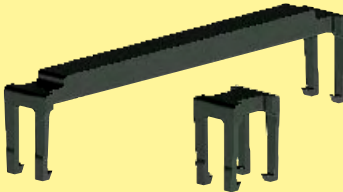
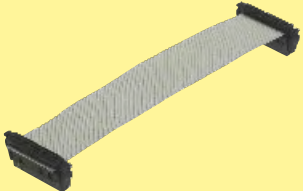
<i>harflex</i> ® connector system – introduction		8
Technical characteristics		10
Male connectors, straight		14
Female connectors, straight		16
Male connectors, angled		18
Female connectors, angled		20
Female connectors, IDC		22
Strain reliefs for female connectors with IDC termination		24
Cable assemblies		26
Company addresses		28

har:flex® CONNECTORS

With *har:flex®*, HARTING has developed a general-purpose PCB connector series for internal and external Device Connectivity. The continuous scalability by an even number of contacts, i.e. from 6 to 100, of the HARTING's *har:flex®* mezzanine connector series is a special feature forming an ideal basis for customized applications. The advantage is clearly evident considering that the connector is always optimized to suit specific applications on the device PCB, while also covering the medium- and small-scale volume range that is typical for the production of industrial devices.

This flexibility is new – HARTING turns an individual design into a standard component. No special tooling changes are needed for

customer-specific solutions, thus HARTING can realize a short delivery time.

PRODUCT DIVERSITY

The *har:flex®* product range with SMT termination technology is based on a 1.27 mm grid. With its diverse variants, HARTING provides connectivity solutions for many different board-to-board and cable-to-board applications. For example, two straight connectors are used for the mezzanine application, two angled connectors for PCBs on one level, and a combination allows the well-known pairing of mother and daughter cards. By using the IDC cable connector, two PCBs with large space between can be connected with a flat ribbon cable.

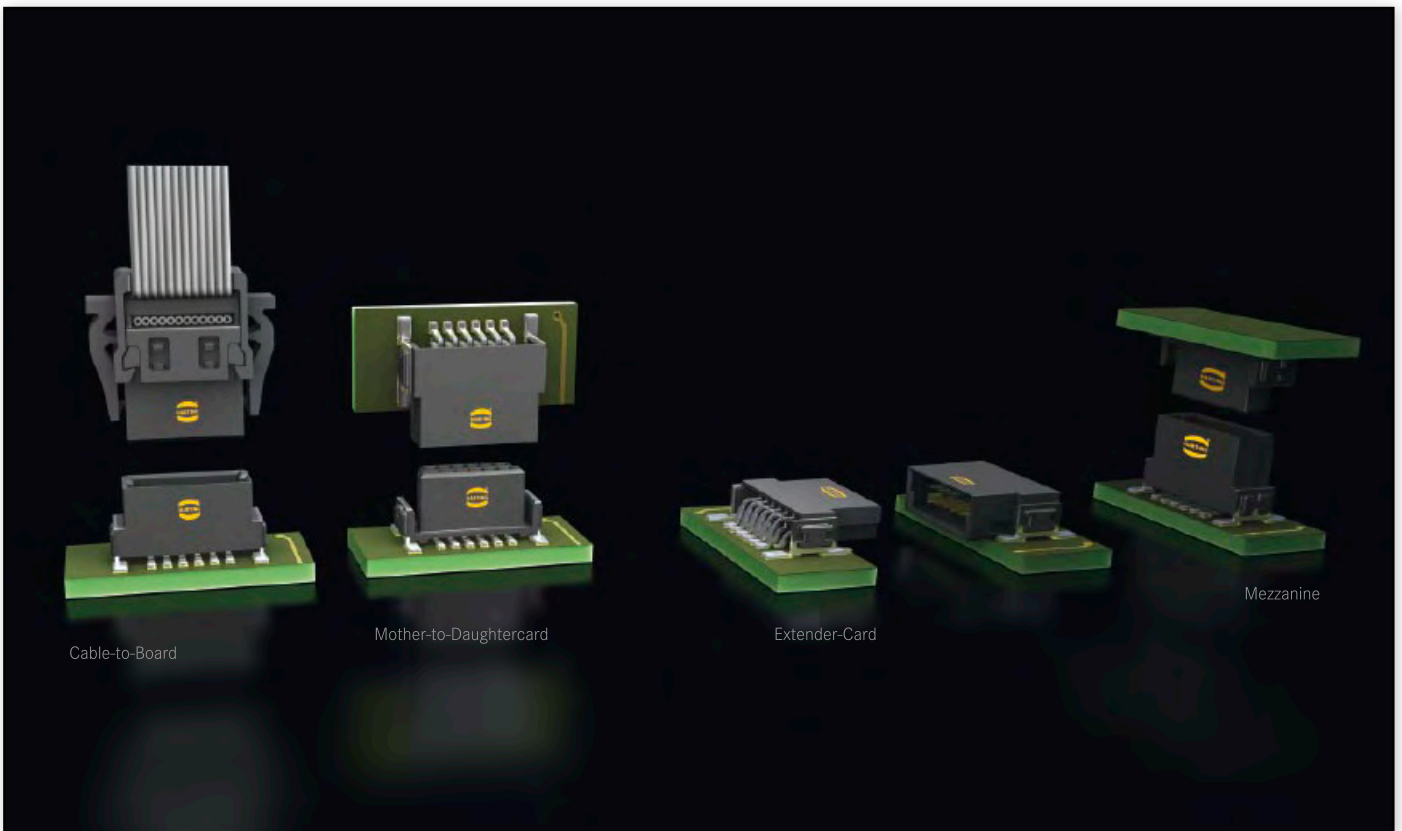

Many pin count options

HARTING has developed a modular tooling concept which offers a broad choice of configurations between 6 and 100 poles in even numbered positions. This flexibility in the choice of number of contacts, combined with high density contact spacing, allow the designer to maximize the use of PCB real estate, thereby achieving overall space savings and cost efficiencies.

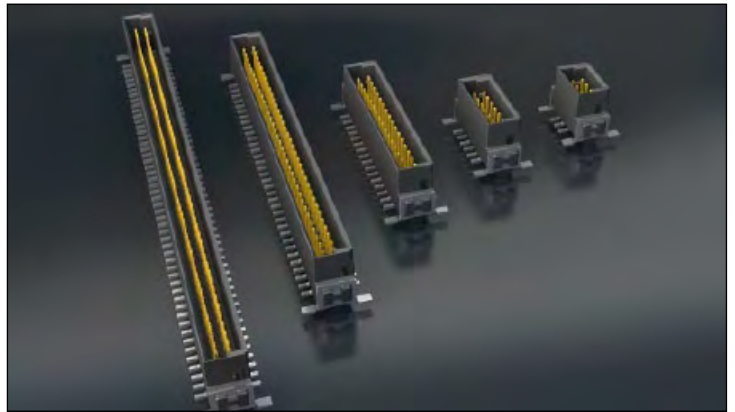

Flexible board-to-board distances

HARTING covers mezzanine applications with a range of straight versions for four different stacking heights that can be used to interconnect PCBs arranged in parallel stacks with spacing between 8.0 mm and 13.8 mm. Additional stacking heights are in development. For applications requiring larger spacing between boards HARTING offers compatible cable-to-board connectors with insulation displacement technology.

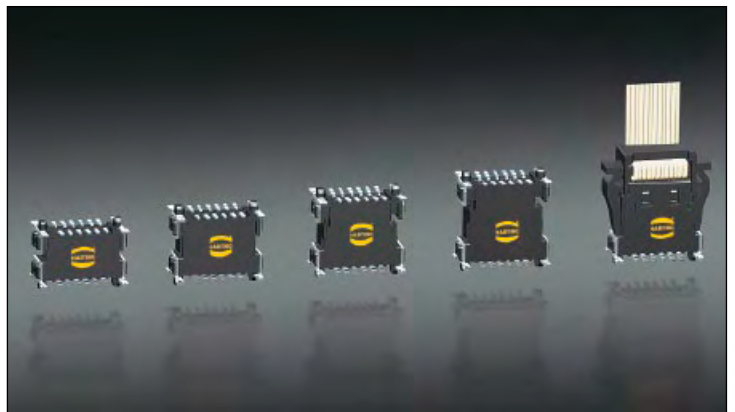

Robust design

The special SMT fixing ensures a robust and enduring connection to the PCB and helps to absorb mechanical stress on the solder contacts resulting from insertion and removal forces.

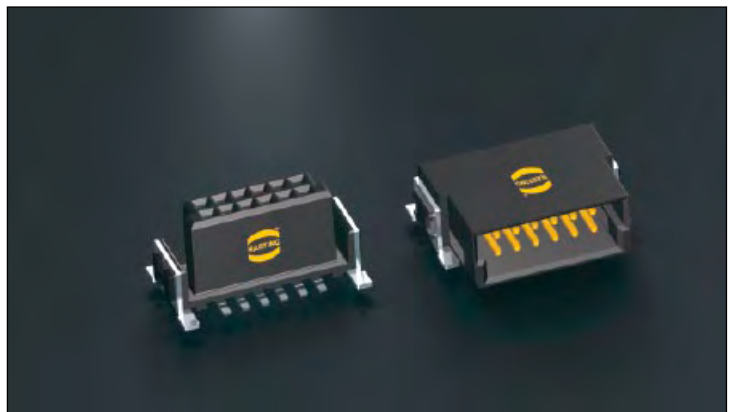

Automated processing features

The har-flex® SMT connectors meet the highest demands in terms of their processing capabilities. Special blister packaging provides protection during shipping and handling, while the "pick and place" pads enable automated assembly of the PCBs. The temperature resistant materials of the insulating body, in combination with consistent testing of the coplanarity of contacts, ensure reliable soldering capabilities of the connectors in the reflow process.



Number of contacts	6, 8, 10 ... 96, 98, 100
Connector pitch	1.27 mm x 1.27 mm [0.050" x 0.050"]
Clearance and creepage distance	
Board connectors (SMT)	min. 0.4 mm
Cable connectors (IDC)	
AWG 30/1 (solid)	min. 0.35 mm
AWG 30/7 (stranded)	min. 0.4 mm
Test voltage $U_{r.m.s.}$	500 V
Contact resistance	< 25 mΩ
Insulation resistance	> 10 GΩ
Insertion and withdrawal force	approx. 0.5 N / contact
Working temperature range	- 55 °C ... + 125 °C
The higher temperature limit includes the local ambient and heating effects of the contacts under load	
Temperature during reflow soldering (acc. to ECA/IPC/JEDEC J-STD-075 Level PSL R0)	min. 150 s > 217 °C min. 30 s > 240 °C
Electrical termination	
Board connectors	SMT (Surface Mount Technology)
Cable connectors	IDC (Insulation Displacement Connection)
Materials	
Moulding material	LCP
UL approval	UL 94-V0
CTI value (Comparative Tracking Index)	175
Contacts base material	Copper alloy
Contact surface	
Mating side	
Board connectors	Au over PdNi (acc. performance level)
Cable connectors	Au over PdNi (acc. performance level)
Termination side	
Board connectors (SMT)	Sn
Cable connectors (IDC)	Sn
Flat cable requirements for IDC connectors	
PVC flat cables:	AWG 30/1 (solid) AWG 30/7 (stranded)
PTFE flat cables:	AWG 30/1 (solid)
Insulation diameter:	min. 0.55 mm - max. 0.75 mm
Working current acc. to IEC 60512	
70 °C ambient temperature @ 80 % derating	
6 pins	1.2 A
32 pins	0.8 A
68 pins	0.75 A
100 pins	0.7 A

Current carrying capacity

The current carrying capacity is limited by maximum temperature of materials for inserts and contacts including terminals.

The current capacity-curve is valid for continuous, not interrupted current-loaded contacts of connectors when simultaneous power on all contacts is given, without exceeding the maximum temperature.

Control and test procedures according to DIN IEC 60512.

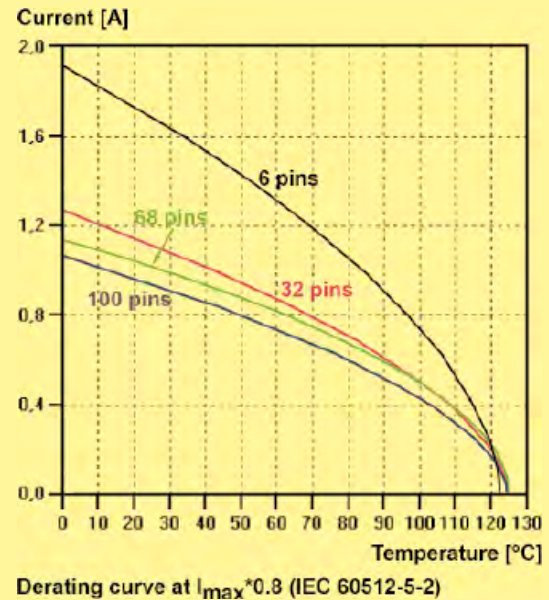

Durability

Performance level 1 (recommended for majority of applications)

Initial 250 mating cycles, 10 days gas test (25 °C/75 % r.h.) using H₂S 10 ppb, NO₂ 200 ppb, CL₂ 10 ppb, SO₂ 200 ppb. Measurement of contact resistance. The remaining 250 mating cycles are subject to measurement of contact resistance and visual inspection. Visual inspection. No abrasion of the contact finish through to the base material. No functional impairment.

Part number definition: 15 2... ...

Performance level 2

Initial 125 mating cycles, 4 days gas test (25 °C/75% r.h.) using H₂S 10 ppb, NO₂ 200 ppb, CL₂ 10 ppb, SO₂ 200 ppb. Measurement of contact resistance. The remaining 125 mating cycles are subject to measurement of contact resistance and visual inspection. Visual inspection. No abrasion of the contact finish through to the base material. No functional impairment.

Part number definition: 15 6... ...

Performance level S4

Defined contact surface of min. 0.06 μm Au over 0.7+0.2 μm PdNi.

Part number definition: 15 5... ...

Working voltage acc. to IEC 60664-1

The working voltage depends on user specific operational conditions. Depending on the installation category, the degree of pollution and the entire electrical environment, the working voltage is different. The standard IEC 60664-1 specifies, in general, the minimum insulation distances for equipment. But it can also be used to determine the maximum working voltage with given requirements.

The following table shows the most common conditions applicable for the *har-flex*® connectors and exemplary calculations for the working voltage. For installation category, degree of pollution and other requirements which are not shown in the table we refer to the IEC 60664-1.

Clearance / Creepage distance	0.4 mm			
CTI-Value	< 400			
Isolation group	III a/b			
Electrical field type	Case A (Inhomogeneous field)		Case B (Homogeneous field)	
Installation category	I	II	I	II
Degree of pollution	1	1	1	1
Working voltage max.	150 V	100 V	150 V	150 V

Explanations:

- CTI value and isolation group are fixed values by the *har-flex*® connector characteristics.
- Installation category I: Equipment is intended for use only in appliances or installation parts, in which no overvoltages can occur. Equipment in this installation category is normally operated at extra low voltage.
- Installation category II: Equipment is intended for use in installations or parts of installations, in which lightning overvoltages need not be considered. Overvoltages caused by switching must be taken into account.
- Pollution degree 1: No pollution or only dry, non-conductive pollution occurs. The pollution has no influence.
- Pollution degree 2: Only non-conductive pollution occurs. A temporary conductive caused by condensation must be expected occasionally.

Part number definition

The *har-flex*® part numbers have 14 digits and are based on the following scheme:



15 *har-flex*® family

Connector style

- 11 straight male connector
1.75 mm stacking height
- 12 straight male connector
3.25 mm stacking height
- 15 angled male connector
- 21 straight female connector
6.25 mm stacking height
- 22 straight female connector
9.05 mm stacking height
- 25 angled female connector
- 29 IDC flat band cable
connector / accessories

Number of contacts

Durability

- 2 performance level 1
- 5 performance level S4
- 6 performance level 2

Termination

- 5 IDC termination
- 6 SMT termination

Counting number

Packaging

- 000 Tape and reel packaging
Tray packaging for
IDC cable connectors
- 333 Samples

Stacking heights of straight connector versions

The har-flex[®] connectors cover mezzanine applications with a range of straight versions for four different stacking heights that can be used to interconnect PCBs arranged in parallel stacks with spacing between 8.0 mm and 13.8 mm.

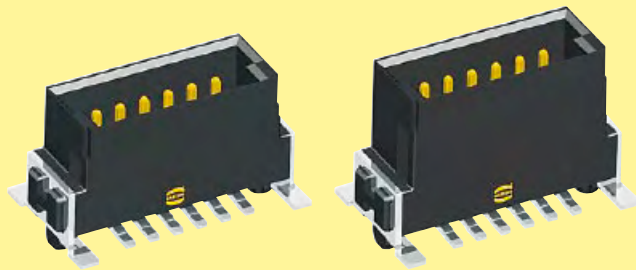

Male 1.75 mm

Male 3.25 mm

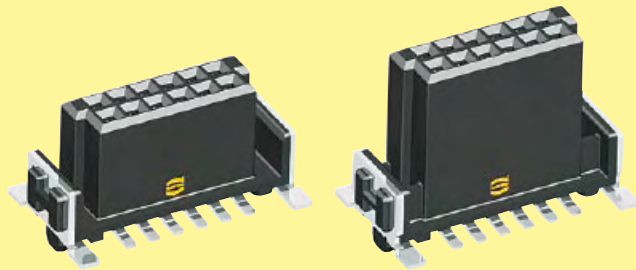

Female 6.25 mm

Female 9.05 mm

Due to the wiping lengths of 1.5 mm, these four connectors cover the distance of 8 mm to 13.8 mm continuously.

14 mm				
13 mm				
12 mm				
11 mm				
10 mm				
9 mm				
8 mm				
stacking heights	male 1.75 mm female 6.25 mm	male 3.25 mm female 6.25 mm	male 1.75 mm female 9.05 mm	male 3.25 mm female 9.05 mm
PCB distance	8 mm - 9.5 mm	9.5 mm - 11 mm	10.8 mm - 12.3 mm	12.3 mm - 13.8 mm
part numbers	15 11 ... 15 21 ...	15 12 ... 15 21 ...	15 11 ... 15 22 ...	15 12 ... 15 22 ...

Mating options

Mezzanine connection

straight female

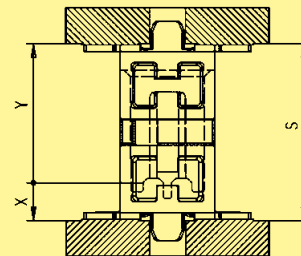

straight male

3.25	9.05	12.3	13.8
1.75	9.05	10.8	12.3
3.25	6.25	9.5	11
1.75	6.25	8	9.5
<i>X</i>	<i>Y</i>	<i>Smin</i>	<i>Smax</i>

* $S_{max} = S_{min} + 1.5$ wiping length with additional contact overlap security

Extender Card connection

EXTENDER CARD CONFIGURATION

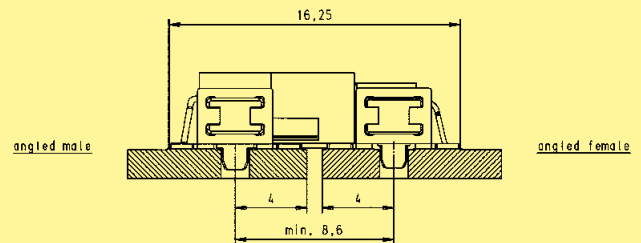

Mother-to-Daughtercard connection

angled female

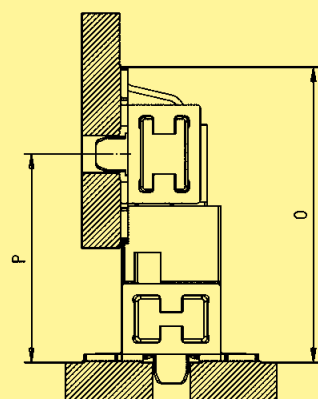

angled male

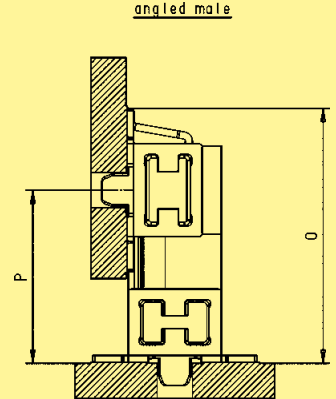

straight male

3.25	10.25	14.08
1.75	8.75	12.58
<i>X</i>	<i>P min.</i>	<i>O</i>

straight female

9.05	10.5	14.33
6.25	7.7	11.53
<i>Y</i>	<i>P min.</i>	<i>O</i>

Mating conditions

Inclination

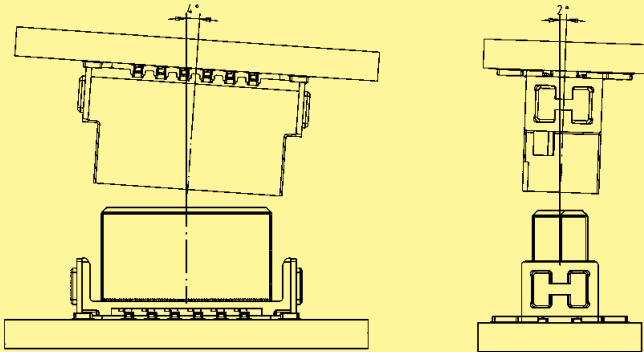

Mismatching

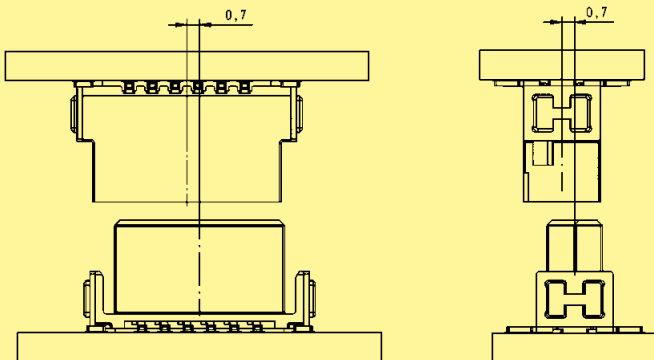

SMT processing notes

The har-flex® SMT connectors meet the highest demands in terms of their processing capabilities.

The connectors are delivered in a tape and reel packaging optimized for automatic assembly machines. A vacuum cover enables the automatic assembly with a vacuum nozzle.

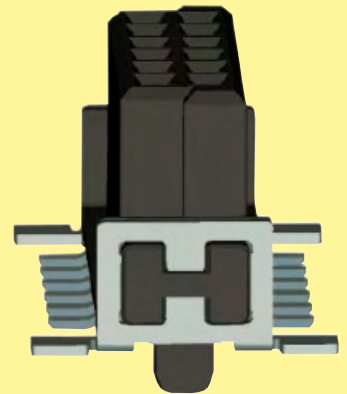

The insulation body material is high temperature resistant, and due to the black colour a secure camera recognition is ensured.

For a reliable SMT solder process, the termination pins are 100 % checked for coplanarity.

Process / Moisture Sensitivity

During the reflow solder process, the connector has to resist extreme variations in temperature. Connectors consist in general of both plastic and metal parts, which have a different behaviour during the solder process. The Process Sensivity and also the Moisture Sensivity are tested according the ECA/IPC/JEDEC J-STD-075 specification.

Process Sensivity:

PSL means Process Sensivity Level. PSL is a rating used to identify a component that is solder process sensitive. Damages of the connector after three times soldering are not permitted (e.g. melted edges).

Moisture Sensivity:

MSL means Moisture Sensivity Level. MSL is a rating indicating a component's susceptibility to damage due to absorbed moisture during storage. Damages of the connector after storage in damp heat and three times soldering are not permitted (e.g. blisters).

The har-flex® connectors are rated with **PSL R0** and **MSL 1**. This is the maximum possible rating in both categories. The har-flex® connector resists three times soldering at the following conditions without damages:

- min. 150 s beyond 217 °C (liquidus temperature, the melting point of the solder paste)
- min. 30 s beyond classification temperature (240 °C / 245 °C for har-flex®)
- Temperature solder profile according to ECA/IPC/JEDEC J-STD-075
- For MSL test, a storage of 168 hours at 85 °C and 85 % rel. humidity was carried out

As the result, the har-flex® connectors are not process sensitive and not moisture sensitive according to ECA/IPC/JEDEC J-STD-075.

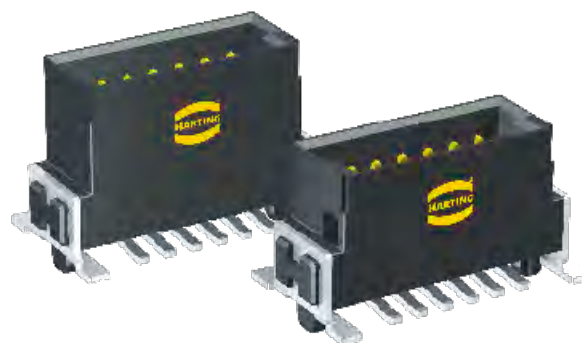

Male connectors, straight

Identification Number of contacts Part No. Dimensions in mm

Male connector, straight,
stacking heights
1.75 / 3.25 mm

6	15 1 . 006 . 601 ...
8	15 1 . 008 . 601 ...
10	15 1 . 010 . 601 ...
12	15 1 . 012 . 601 ...
14	15 1 . 014 . 601 ...
16	15 1 . 016 . 601 ...
18	15 1 . 018 . 601 ...
20	15 1 . 020 . 601 ...
22	15 1 . 022 . 601 ...
24	15 1 . 024 . 601 ...
26	15 1 . 026 . 601 ...
28	15 1 . 028 . 601 ...
30	15 1 . 030 . 601 ...
32	15 1 . 032 . 601 ...
34	15 1 . 034 . 601 ...
36	15 1 . 036 . 601 ...
38	15 1 . 038 . 601 ...
40	15 1 . 040 . 601 ...
42	15 1 . 042 . 601 ...
44	15 1 . 044 . 601 ...
46	15 1 . 046 . 601 ...
48	15 1 . 048 . 601 ...
50	15 1 . 050 . 601 ...
52	15 1 . 052 . 601 ...
54	15 1 . 054 . 601 ...
56	15 1 . 056 . 601 ...
58	15 1 . 058 . 601 ...
60	15 1 . 060 . 601 ...
62	15 1 . 062 . 601 ...
64	15 1 . 064 . 601 ...
66	15 1 . 066 . 601 ...
68	15 1 . 068 . 601 ...
70	15 1 . 070 . 601 ...
72	15 1 . 072 . 601 ...
74	15 1 . 074 . 601 ...
76	15 1 . 076 . 601 ...
78	15 1 . 078 . 601 ...
80	15 1 . 080 . 601 ...
82	15 1 . 082 . 601 ...
84	15 1 . 084 . 601 ...
86	15 1 . 086 . 601 ...
88	15 1 . 088 . 601 ...
90	15 1 . 090 . 601 ...
92	15 1 . 092 . 601 ...
94	15 1 . 094 . 601 ...
96	15 1 . 096 . 601 ...
98	15 1 . 098 . 601 ...
100	15 1 . 100 . 601 ...

A	B	C	D	E	F
2.54	6.96	8.89	5.76	4.76	6.56
3.81	8.23	10.16	7.03	6.03	7.83
5.08	9.50	11.43	8.30	7.30	9.10
6.35	10.77	12.70	9.57	8.57	10.37
7.62	12.04	13.97	10.84	9.84	11.64
8.89	13.31	15.24	12.11	11.11	12.91
10.16	14.58	16.51	13.38	12.38	14.18
11.43	15.85	17.78	14.65	13.65	15.45
12.70	17.12	19.05	15.92	14.92	16.72
13.97	18.39	20.32	17.19	16.19	17.99
15.24	19.66	21.59	18.46	17.46	19.26
16.51	20.93	22.86	19.73	18.73	20.53
17.78	22.20	24.13	21.00	20.00	21.80
19.05	23.47	25.40	22.27	21.27	23.07
20.32	24.74	26.67	23.54	22.54	24.34
21.59	26.01	27.94	24.81	23.81	25.61
22.86	27.28	29.21	26.08	25.08	26.88
24.13	28.55	30.48	27.35	26.35	28.15
25.40	29.82	31.75	28.62	27.62	29.42
26.67	31.09	33.02	29.89	28.89	30.69
27.94	32.36	34.29	31.16	30.16	31.96
29.21	33.63	35.56	32.43	31.43	33.23
30.48	34.90	36.83	33.70	32.70	34.50
31.75	36.17	38.10	34.97	33.97	35.77
33.02	37.44	39.37	36.24	35.24	37.04
34.29	38.71	40.64	37.51	36.51	38.31
35.56	39.98	41.91	38.78	37.78	39.58
36.83	41.25	43.18	40.05	39.05	40.85
38.10	42.52	44.45	41.32	40.32	42.12
39.37	43.79	45.72	42.59	41.59	43.39
40.64	45.06	46.99	43.86	42.86	44.66
41.91	46.33	48.26	45.13	44.13	45.93
43.18	47.60	49.53	46.40	45.40	47.20
44.45	48.87	50.80	47.67	46.67	48.47
45.72	50.14	52.07	48.94	47.94	49.74
46.99	51.41	53.34	50.21	49.21	51.01
48.26	52.68	54.61	51.48	50.48	52.28
49.53	53.95	55.88	52.75	51.75	53.55
50.80	55.22	57.15	54.02	53.02	54.82
52.07	56.49	58.42	55.29	54.29	56.09
53.34	57.76	59.69	56.56	55.56	57.36
54.61	59.03	60.96	57.83	56.83	58.63
55.88	60.30	62.23	59.10	58.10	59.90
57.15	61.57	63.50	60.37	59.37	61.17
58.42	62.84	64.77	61.64	60.64	62.44
59.69	64.11	66.04	62.91	61.91	63.71
60.96	65.38	67.31	64.18	63.18	64.98
62.23	66.65	68.58	65.45	64.45	66.25

Please insert digit
for stacking height

1.75 mm ▶ 1
3.25 mm ▶ 2

for performance level 1
for performance level S4
for performance level 2

2
5
6

333
000

for samples
for 280 pieces on reel



Male connectors, straight

Identification

Drawing

Dimensions in mm

Dimensions

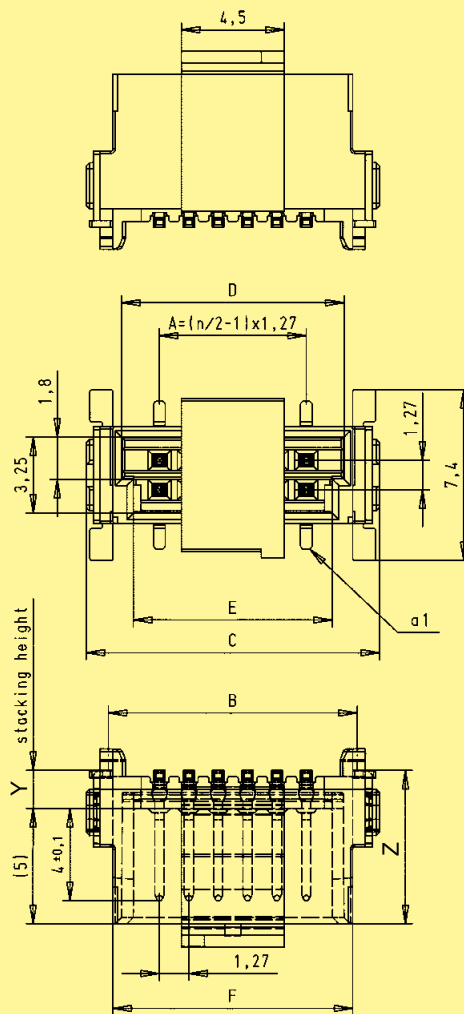

stacking height Y	X	Z
1.75	7.6	6.6
3.25	9.1	8.1

PCB layout

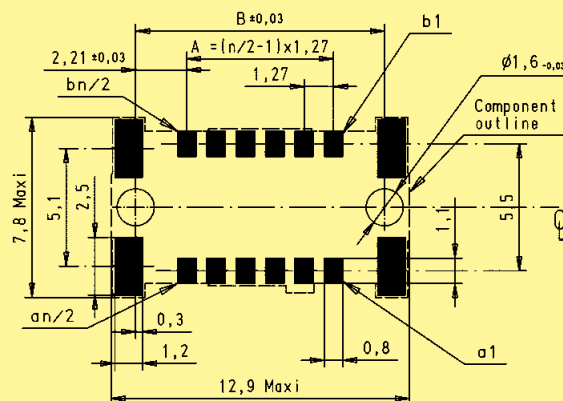



Female connectors, straight

Identification Number of contacts Part No. Dimensions in mm

Female connector, straight, stacking heights 6.25 / 9.05 mm

6	15 2 . 006 . 601 . . .
8	15 2 . 008 . 601 . . .
10	15 2 . 010 . 601 . . .
12	15 2 . 012 . 601 . . .
14	15 2 . 014 . 601 . . .
16	15 2 . 016 . 601 . . .
18	15 2 . 018 . 601 . . .
20	15 2 . 020 . 601 . . .
22	15 2 . 022 . 601 . . .
24	15 2 . 024 . 601 . . .
26	15 2 . 026 . 601 . . .
28	15 2 . 028 . 601 . . .
30	15 2 . 030 . 601 . . .
32	15 2 . 032 . 601 . . .
34	15 2 . 034 . 601 . . .
36	15 2 . 036 . 601 . . .
38	15 2 . 038 . 601 . . .
40	15 2 . 040 . 601 . . .
42	15 2 . 042 . 601 . . .
44	15 2 . 044 . 601 . . .
46	15 2 . 046 . 601 . . .
48	15 2 . 048 . 601 . . .
50	15 2 . 050 . 601 . . .
52	15 2 . 052 . 601 . . .
54	15 2 . 054 . 601 . . .
56	15 2 . 056 . 601 . . .
58	15 2 . 058 . 601 . . .
60	15 2 . 060 . 601 . . .
62	15 2 . 062 . 601 . . .
64	15 2 . 064 . 601 . . .
66	15 2 . 066 . 601 . . .
68	15 2 . 068 . 601 . . .
70	15 2 . 070 . 601 . . .
72	15 2 . 072 . 601 . . .
74	15 2 . 074 . 601 . . .
76	15 2 . 076 . 601 . . .
78	15 2 . 078 . 601 . . .
80	15 2 . 080 . 601 . . .
82	15 2 . 082 . 601 . . .
84	15 2 . 084 . 601 . . .
86	15 2 . 086 . 601 . . .
88	15 2 . 088 . 601 . . .
90	15 2 . 090 . 601 . . .
92	15 2 . 092 . 601 . . .
94	15 2 . 094 . 601 . . .
96	15 2 . 096 . 601 . . .
98	15 2 . 098 . 601 . . .
100	15 2 . 100 . 601 . . .

A	B	C	D	E
2.54	6.96	8.89	5.56	4.56
3.81	8.23	10.16	6.83	5.83
5.08	9.50	11.43	8.10	7.10
6.35	10.77	12.70	9.37	8.37
7.62	12.04	13.97	10.64	9.64
8.89	13.31	15.24	11.91	10.91
10.16	14.58	16.51	13.18	12.18
11.43	15.85	17.78	14.45	13.45
12.70	17.12	19.05	15.72	14.72
13.97	18.39	20.32	16.99	15.99
15.24	19.66	21.59	18.26	17.26
16.51	20.93	22.86	19.53	18.53
17.78	22.20	24.13	20.80	19.80
19.05	23.47	25.40	22.07	21.07
20.32	24.74	26.67	23.34	22.34
21.59	26.01	27.94	24.61	23.61
22.86	27.28	29.21	25.88	24.88
24.13	28.55	30.48	27.15	26.15
25.40	29.82	31.75	28.42	27.42
26.67	31.09	33.02	29.69	28.69
27.94	32.36	34.29	30.96	29.96
29.21	33.63	35.56	32.23	31.23
30.48	34.90	36.83	33.50	32.50
31.75	36.17	38.10	34.77	33.77
33.02	37.44	39.37	36.04	35.04
34.29	38.71	40.64	37.31	36.31
35.56	39.98	41.91	38.58	37.58
36.83	41.25	43.18	39.85	38.85
38.10	42.52	44.45	41.12	40.12
39.37	43.79	45.72	42.39	41.39
40.64	45.06	46.99	43.66	42.66
41.91	46.33	48.26	44.93	43.93
43.18	47.60	49.53	46.20	45.20
44.45	48.87	50.80	47.47	46.47
45.72	50.14	52.07	48.74	47.74
46.99	51.41	53.34	50.01	49.01
48.26	52.68	54.61	51.28	50.28
49.53	53.95	55.88	52.55	51.55
50.80	55.22	57.15	53.82	52.82
52.07	56.49	58.42	55.09	54.09
53.34	57.76	59.69	56.36	55.36
54.61	59.03	60.96	57.63	56.63
55.88	60.30	62.23	58.90	57.90
57.15	61.57	63.50	60.17	59.17
58.42	62.84	64.77	61.44	60.44
59.69	64.11	66.04	62.71	61.71
60.96	65.38	67.31	63.98	62.98
62.23	66.65	68.58	65.25	64.25

Please insert digit for stacking height

6.25 mm ▶ 1
9.05 mm ▶ 2

for performance level 1
for performance level S4
for performance level 2

2
5
6

333
000

for samples
for 280 pieces on reel

available
Q2 / 2012



Male connectors, angled

Identification Number of contacts Part No. Dimensions in mm

Male connector, angled	Number of contacts	Part No.	Dimensions in mm				
			A	B	C	D	E
	6	15 15 006 . 601 . . .	2.54	6.96	8.89	5.76	4.76
	8	15 15 008 . 601 . . .	3.81	8.23	10.16	7.03	6.03
	10	15 15 010 . 601 . . .	5.08	9.50	11.43	8.30	7.30
	12	15 15 012 . 601 . . .	6.35	10.77	12.70	9.57	8.57
	14	15 15 014 . 601 . . .	7.62	12.04	13.97	10.84	9.84
	16	15 15 016 . 601 . . .	8.89	13.31	15.24	12.11	11.11
	18	15 15 018 . 601 . . .	10.16	14.58	16.51	13.38	12.38
	20	15 15 020 . 601 . . .	11.43	15.85	17.78	14.65	13.65
	22	15 15 022 . 601 . . .	12.70	17.12	19.05	15.92	14.92
	24	15 15 024 . 601 . . .	13.97	18.39	20.32	17.19	16.19
	26	15 15 026 . 601 . . .	15.24	19.66	21.59	18.46	17.46
	28	15 15 028 . 601 . . .	16.51	20.93	22.86	19.73	18.73
	30	15 15 030 . 601 . . .	17.78	22.20	24.13	21.00	20.00
	32	15 15 032 . 601 . . .	19.05	23.47	25.40	22.27	21.27
	34	15 15 034 . 601 . . .	20.32	24.74	26.67	23.54	22.54
	36	15 15 036 . 601 . . .	21.59	26.01	27.94	24.81	23.81
	38	15 15 038 . 601 . . .	22.86	27.28	29.21	26.08	25.08
	40	15 15 040 . 601 . . .	24.13	28.55	30.48	27.35	26.35
	42	15 15 042 . 601 . . .	25.40	29.82	31.75	28.62	27.62
	44	15 15 044 . 601 . . .	26.67	31.09	33.02	29.89	28.89
	46	15 15 046 . 601 . . .	27.94	32.36	34.29	31.16	30.16
	48	15 15 048 . 601 . . .	29.21	33.63	35.56	32.43	31.43
	50	15 15 050 . 601 . . .	30.48	34.90	36.83	33.70	32.70
	52	15 15 052 . 601 . . .	31.75	36.17	38.10	34.97	33.97
	54	15 15 054 . 601 . . .	33.02	37.44	39.37	36.24	35.24
	56	15 15 056 . 601 . . .	34.29	38.71	40.64	37.51	36.51
	58	15 15 058 . 601 . . .	35.56	39.98	41.91	38.78	37.78
	60	15 15 060 . 601 . . .	36.83	41.25	43.18	40.05	39.05
	62	15 15 062 . 601 . . .	38.10	42.52	44.45	41.32	40.32
	64	15 15 064 . 601 . . .	39.37	43.79	45.72	42.59	41.59
	66	15 15 066 . 601 . . .	40.64	45.06	46.99	43.86	42.86
	68	15 15 068 . 601 . . .	41.91	46.33	48.26	45.13	44.13
	70	15 15 070 . 601 . . .	43.18	47.60	49.53	46.40	45.40
	72	15 15 072 . 601 . . .	44.45	48.87	50.80	47.67	46.67
	74	15 15 074 . 601 . . .	45.72	50.14	52.07	48.94	47.94
	76	15 15 076 . 601 . . .	46.99	51.41	53.34	50.21	49.21
	78	15 15 078 . 601 . . .	48.26	52.68	54.61	51.48	50.48
	80	15 15 080 . 601 . . .	49.53	53.95	55.88	52.75	51.75
	82	15 15 082 . 601 . . .	50.80	55.22	57.15	54.02	53.02
	84	15 15 084 . 601 . . .	52.07	56.49	58.42	55.29	54.29
	86	15 15 086 . 601 . . .	53.34	57.76	59.69	56.56	55.56
	88	15 15 088 . 601 . . .	54.61	59.03	60.96	57.83	56.83
	90	15 15 090 . 601 . . .	55.88	60.30	62.23	59.10	58.10
	92	15 15 092 . 601 . . .	57.15	61.57	63.50	60.37	59.37
	94	15 15 094 . 601 . . .	58.42	62.84	64.77	61.64	60.64
	96	15 15 096 . 601 . . .	59.69	64.11	66.04	62.91	61.91
	98	15 15 098 . 601 . . .	60.96	65.38	67.31	64.18	63.18
	100	15 15 100 . 601 . . .	62.23	66.65	68.58	65.45	64.45

for performance level 1
for performance level S4
for performance level 2

2
5
6

333
000

for samples
for 560 pieces on reel

available
Q2 / 2012

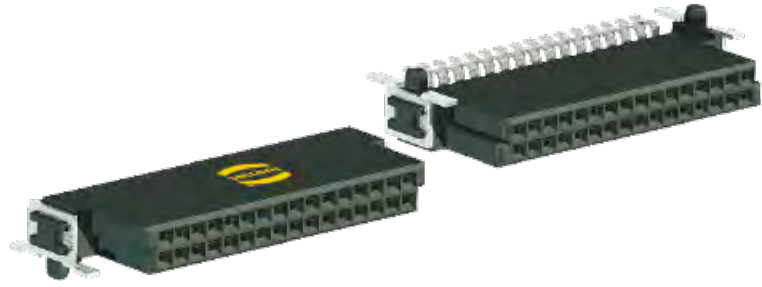

Female connectors, angled

Identification Number of contacts Part No. Dimensions in mm

Female connector,
angled

Number of contacts	Part No.
6	15 25 006 . 601 ...
8	15 25 008 . 601 ...
10	15 25 010 . 601 ...
12	15 25 012 . 601 ...
14	15 25 014 . 601 ...
16	15 25 016 . 601 ...
18	15 25 018 . 601 ...
20	15 25 020 . 601 ...
22	15 25 022 . 601 ...
24	15 25 024 . 601 ...
26	15 25 026 . 601 ...
28	15 25 028 . 601 ...
30	15 25 030 . 601 ...
32	15 25 032 . 601 ...
34	15 25 034 . 601 ...
36	15 25 036 . 601 ...
38	15 25 038 . 601 ...
40	15 25 040 . 601 ...
42	15 25 042 . 601 ...
44	15 25 044 . 601 ...
46	15 25 046 . 601 ...
48	15 25 048 . 601 ...
50	15 25 050 . 601 ...
52	15 25 052 . 601 ...
54	15 25 054 . 601 ...
56	15 25 056 . 601 ...
58	15 25 058 . 601 ...
60	15 25 060 . 601 ...
62	15 25 062 . 601 ...
64	15 25 064 . 601 ...
66	15 25 066 . 601 ...
68	15 25 068 . 601 ...
70	15 25 070 . 601 ...
72	15 25 072 . 601 ...
74	15 25 074 . 601 ...
76	15 25 076 . 601 ...
78	15 25 078 . 601 ...
80	15 25 080 . 601 ...
82	15 25 082 . 601 ...
84	15 25 084 . 601 ...
86	15 25 086 . 601 ...
88	15 25 088 . 601 ...
90	15 25 090 . 601 ...
92	15 25 092 . 601 ...
94	15 25 094 . 601 ...
96	15 25 096 . 601 ...
98	15 25 098 . 601 ...
100	15 25 100 . 601 ...

A	B	C	D	E
2.54	6.96	8.89	5.56	4.56
3.81	8.23	10.16	6.83	5.83
5.08	9.50	11.43	8.10	7.10
6.35	10.77	12.70	9.37	8.37
7.62	12.04	13.97	10.64	9.64
8.89	13.31	15.24	11.91	10.91
10.16	14.58	16.51	13.18	12.18
11.43	15.85	17.78	14.45	13.45
12.70	17.12	19.05	15.72	14.72
13.97	18.39	20.32	16.99	15.99
15.24	19.66	21.59	18.26	17.26
16.51	20.93	22.86	19.53	18.53
17.78	22.20	24.13	20.80	19.80
19.05	23.47	25.40	22.07	21.07
20.32	24.74	26.67	23.34	22.34
21.59	26.01	27.94	24.61	23.61
22.86	27.28	29.21	25.88	24.88
24.13	28.55	30.48	27.15	26.15
25.40	29.82	31.75	28.42	27.42
26.67	31.09	33.02	29.69	28.69
27.94	32.36	34.29	30.96	29.96
29.21	33.63	35.56	32.23	31.23
30.48	34.90	36.83	33.50	32.50
31.75	36.17	38.10	34.77	33.77
33.02	37.44	39.37	36.04	35.04
34.29	38.71	40.64	37.31	36.31
35.56	39.98	41.91	38.58	37.58
36.83	41.25	43.18	39.85	38.85
38.10	42.52	44.45	41.12	40.12
39.37	43.79	45.72	42.39	41.39
40.64	45.06	46.99	43.66	42.66
41.91	46.33	48.26	44.93	43.93
43.18	47.60	49.53	46.20	45.20
44.45	48.87	50.80	47.47	46.47
45.72	50.14	52.07	48.74	47.74
46.99	51.41	53.34	50.01	49.01
48.26	52.68	54.61	51.28	50.28
49.53	53.95	55.88	52.55	51.55
50.80	55.22	57.15	53.82	52.82
52.07	56.49	58.42	55.09	54.09
53.34	57.76	59.69	56.36	55.36
54.61	59.03	60.96	57.63	56.63
55.88	60.30	62.23	58.90	57.90
57.15	61.57	63.50	60.17	59.17
58.42	62.84	64.77	61.44	60.44
59.69	64.11	66.04	62.71	61.71
60.96	65.38	67.31	63.98	62.98
62.23	66.65	68.58	65.25	64.25

for performance level 1
for performance level S4
for performance level 2

2
5
6

333
000

for samples
for 560 pieces on reel

available
Q2 / 2012



Female connectors, angled

Identification

Drawing

Dimensions in mm

Dimensions

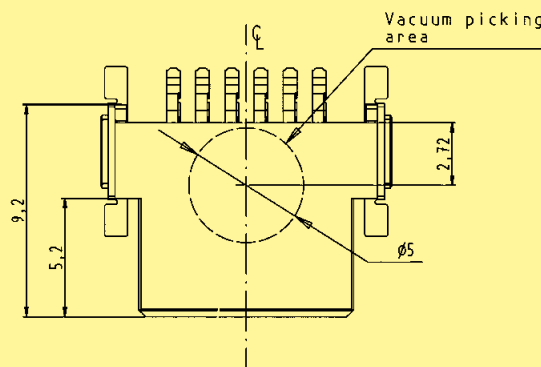
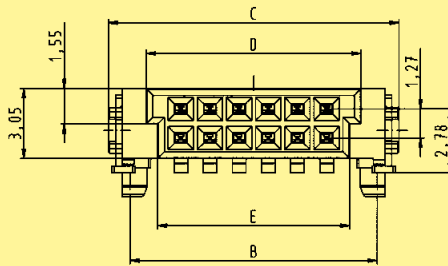
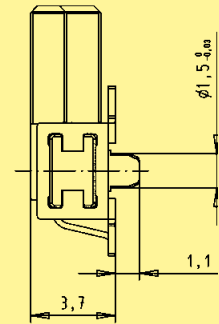
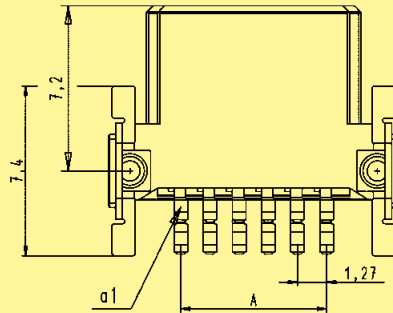

PCB layout

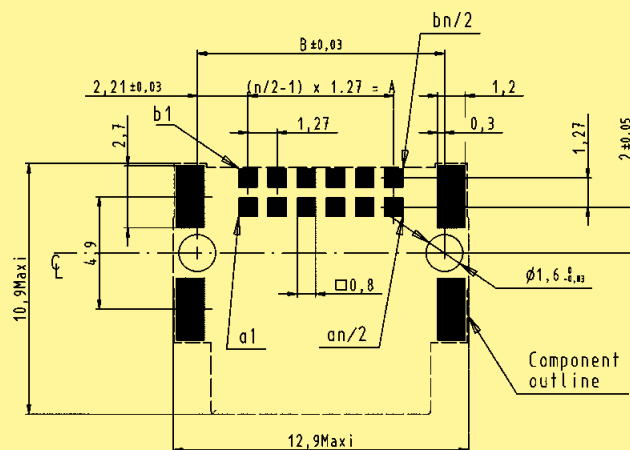



Female connectors, IDC

Identification Number of contacts Part No. Dimensions in mm

Female connector, IDC in a tray packaging

6	15 29 006	. 50 . 000
8	15 29 008	. 50 . 000
10	15 29 010	. 50 . 000
12	15 29 012	. 50 . 000
14	15 29 014	. 50 . 000
16	15 29 016	. 50 . 000
18	15 29 018	. 50 . 000
20	15 29 020	. 50 . 000
22	15 29 022	. 50 . 000
24	15 29 024	. 50 . 000
26	15 29 026	. 50 . 000
28	15 29 028	. 50 . 000
30	15 29 030	. 50 . 000
32	15 29 032	. 50 . 000
34	15 29 034	. 50 . 000
36	15 29 036	. 50 . 000
38	15 29 038	. 50 . 000
40	15 29 040	. 50 . 000
42	15 29 042	. 50 . 000
44	15 29 044	. 50 . 000
46	15 29 046	. 50 . 000
48	15 29 048	. 50 . 000
50	15 29 050	. 50 . 000
52	15 29 052	. 50 . 000
54	15 29 054	. 50 . 000
56	15 29 056	. 50 . 000
58	15 29 058	. 50 . 000
60	15 29 060	. 50 . 000
62	15 29 062	. 50 . 000
64	15 29 064	. 50 . 000
66	15 29 066	. 50 . 000
68	15 29 068	. 50 . 000
70	15 29 070	. 50 . 000
72	15 29 072	. 50 . 000
74	15 29 074	. 50 . 000
76	15 29 076	. 50 . 000
78	15 29 078	. 50 . 000
80	15 29 080	. 50 . 000
82	15 29 082	. 50 . 000
84	15 29 084	. 50 . 000
86	15 29 086	. 50 . 000
88	15 29 088	. 50 . 000
90	15 29 090	. 50 . 000
92	15 29 092	. 50 . 000
94	15 29 094	. 50 . 000
96	15 29 096	. 50 . 000
98	15 29 098	. 50 . 000
100	15 29 100	. 50 . 000

A	B	C	D	E
2.54	11.59	5.56	4.56	15.00
3.81	12.86	6.83	5.83	15.00
5.08	14.13	8.10	7.10	15.00
6.35	15.40	9.37	8.37	15.00
7.62	16.67	10.64	9.64	15.00
8.89	17.94	11.91	10.91	15.00
10.16	19.21	13.18	12.18	15.00
11.43	20.48	14.45	13.45	15.00
12.70	21.75	15.72	14.72	15.00
13.97	23.02	16.99	15.99	15.00
15.24	24.29	18.26	17.26	15.00
16.51	25.56	19.53	18.53	15.00
17.78	26.83	20.80	19.80	15.00
19.05	28.10	22.07	21.07	15.00
20.32	29.37	23.34	22.34	15.00
21.59	30.64	24.61	23.61	15.00
22.86	31.91	25.88	24.88	15.00
24.13	33.18	27.15	26.15	15.00
25.40	34.45	28.42	27.42	15.00
26.67	35.72	29.69	28.69	15.00
27.94	36.99	30.96	29.96	15.00
29.21	38.26	32.23	31.23	15.00
30.48	39.53	33.50	32.50	15.00
31.75	40.80	34.77	33.77	15.00
33.02	42.07	36.04	35.04	15.00
34.29	43.34	37.31	36.31	15.00
35.56	44.61	38.58	37.58	15.00
36.83	45.88	39.85	38.85	16.20
38.10	47.15	41.12	40.12	16.20
39.37	48.42	42.39	41.39	16.20
40.64	49.69	43.66	42.66	16.20
41.91	50.96	44.93	43.93	16.20
43.18	52.23	46.20	45.20	16.20
44.45	53.50	47.47	46.47	16.20
45.72	54.77	48.74	47.74	16.20
46.99	56.04	50.01	49.01	16.20
48.26	57.31	51.28	50.28	16.20
49.53	58.58	52.55	51.55	16.20
50.80	59.85	53.82	52.82	16.20
52.07	61.12	55.09	54.09	16.20
53.34	62.39	56.36	55.36	16.20
54.61	63.66	57.63	56.63	16.20
55.88	64.93	58.90	57.90	16.20
57.15	66.20	60.17	59.17	16.20
58.42	67.47	61.44	60.44	16.20
59.69	68.74	62.71	61.71	16.20
60.96	70.01	63.98	62.98	16.20
62.23	71.28	65.25	64.25	16.20

Please insert digit

- for performance level 1 ▶ 2
- for performance level S4 ▶ 5
- for performance level 2 ▶ 6

without strain relief
with strain relief

1
2



Female connectors, IDC

Identification

Drawing

Dimensions in mm

Dimensions

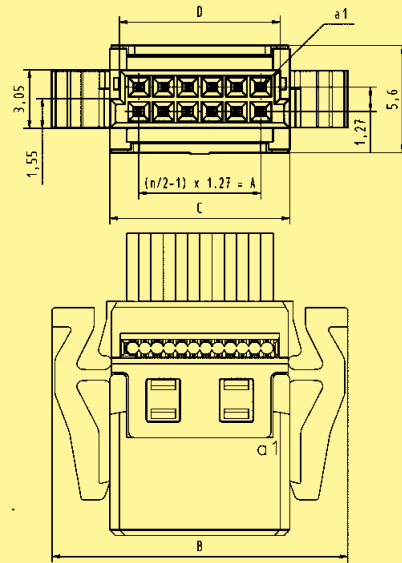

PVC FLAT CABLE : AWG 30/1 (solid)
 AWG 30/7 (stranded)
 PTFE FLAT CABLE : AWG 30/1 (Solid)
 ø0.55 mini - ø0.75 maxi

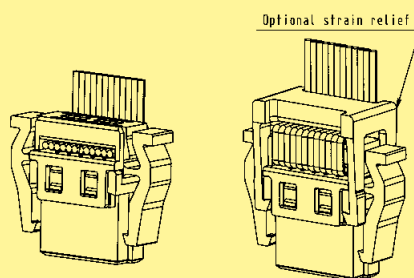
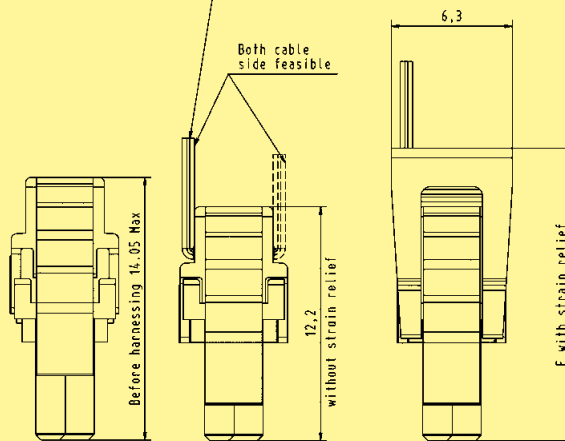



Strain reliefs for female connectors,
IDC

Identification	Number of contacts	Part No.	Dimensions in mm
Strain reliefs for female connectors, IDC	6	15 29 006 0503 000	A
	8	15 29 008 0503 000	7.31
	10	15 29 010 0503 000	8.58
	12	15 29 012 0503 000	9.85
	14	15 29 014 0503 000	11.12
	16	15 29 016 0503 000	12.39
	18	15 29 018 0503 000	13.66
	20	15 29 020 0503 000	14.93
	22	15 29 022 0503 000	16.20
	24	15 29 024 0503 000	17.47
	26	15 29 026 0503 000	18.74
	28	15 29 028 0503 000	20.01
	30	15 29 030 0503 000	21.28
	32	15 29 032 0503 000	22.55
	34	15 29 034 0503 000	23.82
	36	15 29 036 0503 000	25.09
	38	15 29 038 0503 000	26.36
	40	15 29 040 0503 000	27.63
	42	15 29 042 0503 000	28.90
	44	15 29 044 0503 000	30.17
	46	15 29 046 0503 000	31.44
	48	15 29 048 0503 000	32.71
	50	15 29 050 0503 000	33.98
	52	15 29 052 0503 000	35.25
	54	15 29 054 0503 000	36.52
	56	15 29 056 0503 000	37.79
	58	15 29 058 0503 000	39.06
	60	15 29 060 0503 000	40.33
	62	15 29 062 0503 000	41.60
	64	15 29 064 0503 000	42.87
66	15 29 066 0503 000	44.14	
68	15 29 068 0503 000	45.41	
70	15 29 070 0503 000	46.68	
72	15 29 072 0503 000	47.95	
74	15 29 074 0503 000	49.22	
76	15 29 076 0503 000	50.49	
78	15 29 078 0503 000	51.76	
80	15 29 080 0503 000	53.03	
82	15 29 082 0503 000	54.30	
84	15 29 084 0503 000	55.57	
86	15 29 086 0503 000	56.84	
88	15 29 088 0503 000	58.11	
90	15 29 090 0503 000	59.38	
92	15 29 092 0503 000	60.65	
94	15 29 094 0503 000	61.92	
96	15 29 096 0503 000	63.19	
98	15 29 098 0503 000	64.46	
100	15 29 100 0503 000	65.73	
			67.00



Strain reliefs for female connectors, IDC

Identification

Drawing

Dimensions in mm

Dimensions

6 – 58 contacts

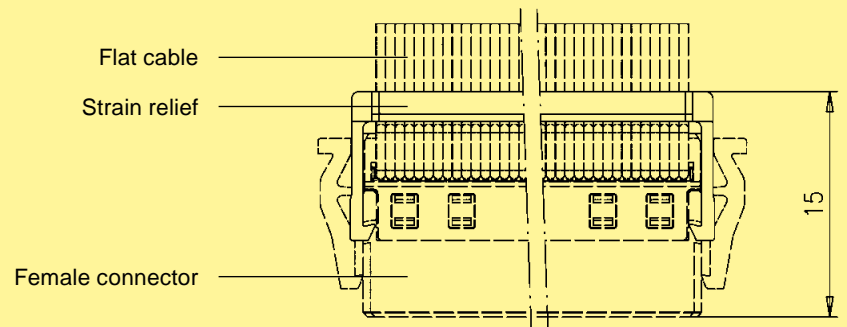
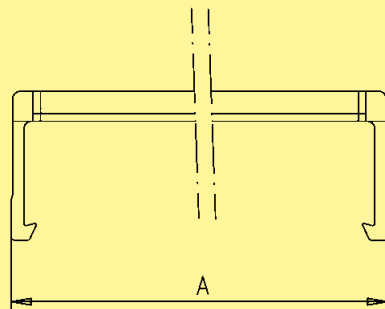

60 – 100 contacts

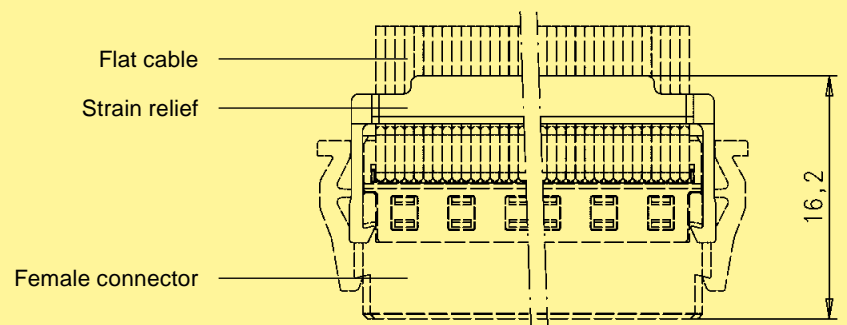
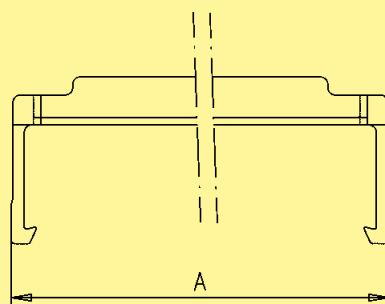

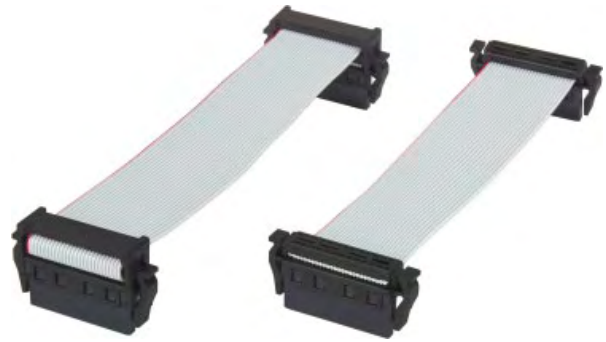

Cable assemblies

Identification	Part No.	Drawing	Dimensions in mm
<p>Cable assembly har:flex® 6 pole</p> <p>Cable: Flat cable, 6 wires, AWG 30, 0.635 mm pitch</p> <p>Wiring: 1:1</p> <p>Connectors with strain relief</p> <p>Length: L = 0.1 m L = 0.2 m L = 0.5 m</p>	<p>33 15 243 0100 001 33 15 243 0200 002 33 15 243 0500 003</p>		
<p>Cable assembly har:flex® 12 pole</p> <p>Cable: Flat cable, 12 wires, AWG 30, 0.635 mm pitch</p> <p>Wiring: 1:1</p> <p>Connectors with strain relief</p> <p>Length: L = 0.1 m L = 0.2 m L = 0.5 m</p>	<p>33 15 243 0100 004 33 15 243 0200 005 33 15 243 0500 006</p>		
<p>Cable assembly har:flex® 26 pole</p> <p>Cable: Flat cable, 26 wires, AWG 30, 0.635 mm pitch</p> <p>Wiring: 1:1</p> <p>Connectors with strain relief</p> <p>Length: L = 0.1 m L = 0.2 m L = 0.5 m</p>	<p>33 15 243 0100 007 33 15 243 0200 008 33 15 243 0500 009</p>		

Please send me further information:



Interface Connectors



Device Connectivity



Industrial Connectors Han®



Connectors DIN 41612



Intelligent Network Solutions

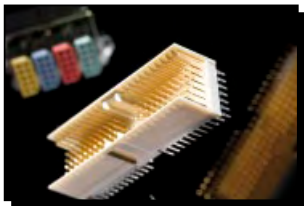

Coaxial and Metric Connectors



Application brochure

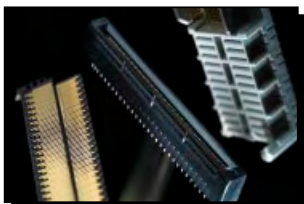

TCA Connectors



High Speed Backplanes



Sender:

Company: _____

Department: _____

Name: _____

Prenome: _____

Function: _____

Street: _____

Postcode/Town: _____

Country: _____

Phone: _____

Fax: _____

E-Mail: _____

Please send it by post or fax to your local HARTING representatives (see page addresses) or visit us under www.HARTING.com.

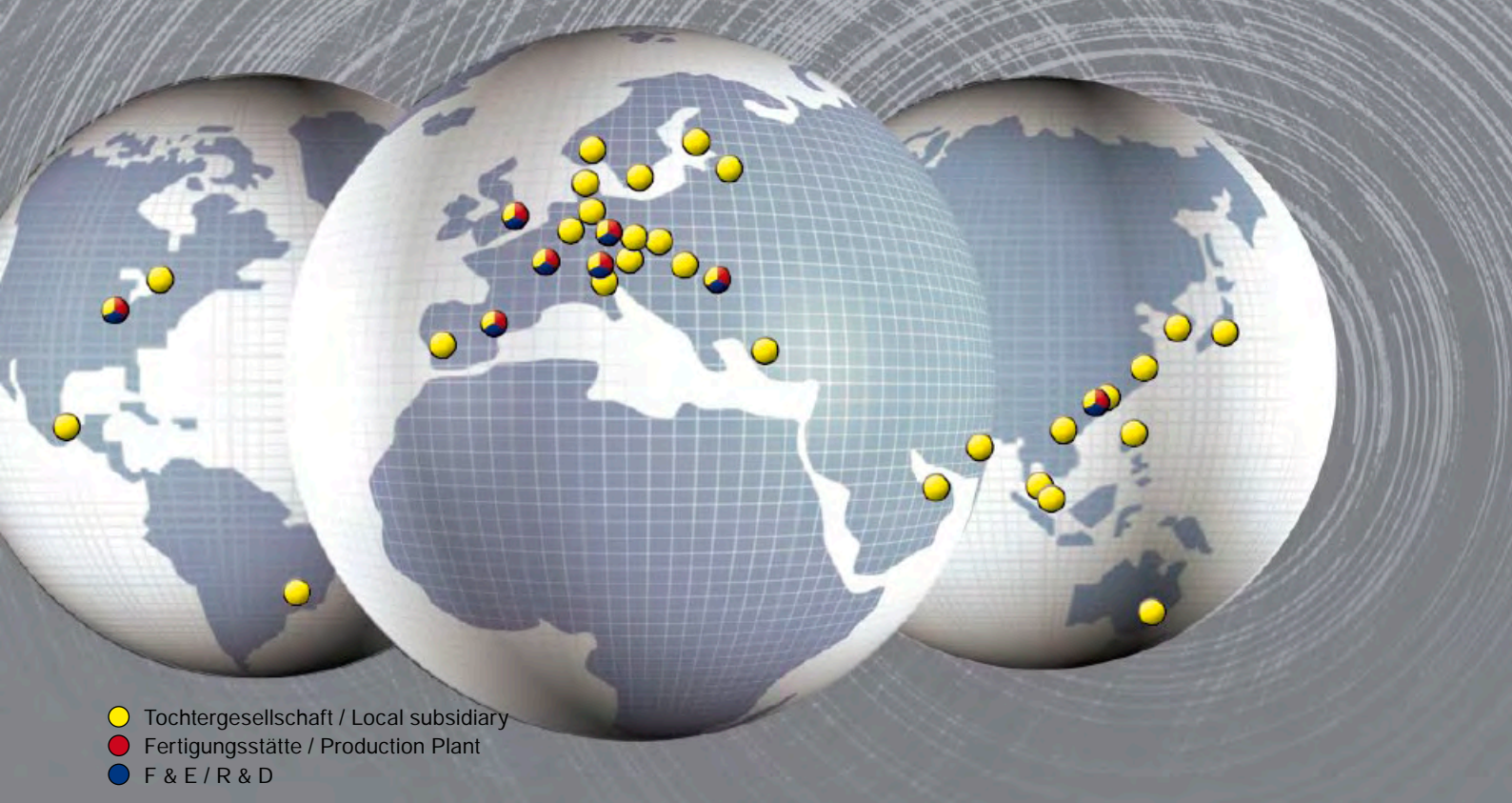

- Tochtergesellschaft / Local subsidiary
- Fertigungsstätte / Production Plant
- F & E / R & D

Sales Network – worldwide



Albania

see Eastern Europe

Argentina

Condelectric S.A.
Hipólito Yrigoyen 2591, 1640 - Martínez
Buenos Aires – Argentina
Phone +54 11 4836 1053
Fax +54 11 4836 1053
comercial@condelectric.com.ar

Armenia

see Eastern Europe

Australia

HARTING Pty Ltd
Suite 11 / 2 Enterprise Drive
Bundoora 3083, AUS-Victoria
Phone +61 3 9466 7088
Fax +61 3 9466 7099
au@HARTING.com
www.HARTING.com.au

Austria

HARTING Ges.m.b.H.
Deutschstraße 19, A-1230 Wien
Phone +431 6162121
Fax +431 6162121-21
at@HARTING.com
www.HARTING.at

Azerbaijan

see Eastern Europe

Bahrain

see United Arab Emirates

Belgium

HARTING N.V./S.A.
Z.3 Doornveld 23, B-1731 Zellik
Phone +32 2 466 0190
Fax +32 2 466 7855
be@HARTING.com
www.HARTING.be

Bosnia and Herzegovina

see Eastern Europe

Brazil

HARTING Ltda.
Rua Major Paladino 128 –
Prédio 11
CEP 05307-000 – São Paulo –
SP – Brasil
Phone +55 11 5035 0073
Fax +55 11 5034 4743
br@HARTING.com
www.HARTING.com.br

Brunei

see Singapore

Bulgaria

see Eastern Europe

Canada

HARTING Canada Inc.
8455 Trans-Canada Hwy., Suite 202
St. Laurent, QC, H4S1Z1, Canada
Tel. 855-659-6653, Fax 855-659-6654
info.ca@HARTING.com
www.HARTING.ca

China

HARTING Sales (Shanghai) Limited
Room 5403, HK New World Tower
300 Huai Hai Road (M.), Luwan District
Shanghai 200021, China
Phone +86 21 6386 2200
Fax +86 21 6386 8636
cn@HARTING.com
www.HARTING.com.cn

Croatia

see Eastern Europe

Czech Republic

HARTING s.r.o.
Mlýnská 2, CZ-160 00 Praha 6
Phone +420 220 380 460
Fax +420 220 380 461
cz@HARTING.com
www.HARTING.cz

Denmark

HARTING ApS
Hjulgagervej 4a
DK - 7100 Vejle
Phone +45 70 25 00 32
Fax +45 75 80 64 99
dk@HARTING.com
www.HARTING.com

Eastern Europe

HARTING Eastern Europe GmbH
Bamberger Straße 7
D-01187 Dresden
Phone +49 351 4361 760
Fax +49 351 436 1770
Eastern.Europe@HARTING.com
www.HARTING.com

Estonia

see Eastern Europe

Finland

HARTING Oy
Teknobulevardi 3-5
FI-01530 Vantaa
Phone +358 207 291 510
Fax +358 207 291 511
fi@HARTING.com
www.HARTING.fi

France

HARTING France
181 avenue des Nations, Paris Nord 2
BP 66058 Tremblay en France
F-95972 Roissy Charles de Gaulle
Cédex
Phone +33 1 4938 3400
Fax +33 1 4863 2306
fr@HARTING.com
www.HARTING.fr

Germany

HARTING Deutschland GmbH & Co. KG
P.O. Box 2451, D-32381 Minden
Simeons carré 1, D-32427 Minden
Phone +49 571 8896 0
Fax +49 571 8896 282
de@HARTING.com
www.HARTING-Deutschland.de

Georgia

see Eastern Europe

Great Britain

HARTING Ltd., Caswell Road
Brackmills Industrial Estate
GB-Northampton, NN4 7PW
Phone +44 1604 827 500
Fax +44 1604 706 777
gb@HARTING.com
www.HARTING.co.uk

Hong Kong

HARTING (HK) Limited
Regional Office Asia Pacific
3512 Metroplaza Tower 1
223 Hing Fong Road
Kwai Fong, N. T., Hong Kong
Phone +852 2423 7338
Fax +852 2480 4378
ap@HARTING.com
www.HARTING.com.hk

Hungary

HARTING Magyarország Kft.
Fehérvári út 89-95, H-1119 Budapest
Phone +36 1 205 34 64
Fax +36 1 205 34 65
hu@HARTING.com
www.HARTING.hu

India

HARTING India Private Limited
No. D, 4th Floor, 'Doshi Towers'
No. 156 Poonamallee High Road
Kilpauk, Chennai 600 010
Tamil Nadu, India
Phone +91 44 435604 15 / 416
Fax +91 44 435604 17
in@HARTING.com
www.HARTING.in

Indonesia

see Malaysia

Israel

COMTEL
Israel Electronic Solutions Ltd.
Bet Hapamon, 20 Hataas st.
P.O.Box 66
Kefar-Saba 44425
Phone +972-9-7677240
Fax +972-9-7677243
sales@comtel.co.il
www.comtel.co.il

Italy

HARTING SpA
Via Dell' Industria 7
I-20090 Vimodrone (Milano)
Phone +39 02 250801
Fax +39 02 2650 597
it@HARTING.com
www.HARTING.it

Japan

HARTING K. K.
Yusen Shin-Yokohama 1 Chome Bldg., 2F
1-7-9, Shin-Yokohama, Kohoku
Yokohama 222-0033 Japan
Phone +81 45 476 3456
Fax +81 45 476 3466
jp@HARTING.com
www.HARTING.co.jp

Jordan

see United Arab Emirates

Kazakhstan

see Eastern Europe

Kirghizia

see Eastern Europe

Korea (South)

HARTING Korea Limited
#308 Yatap Leaders Building
342-1, Yatap-dong, Bundang-gu
Sungnam-City, Kyunggi-do
463-828, Republic of Korea
Phone +82 31 781 4615
Fax +82 31 781 4616
kr@HARTING.com
www.HARTING.co.kr

Kosovo

see Eastern Europe

Kuwait

see United Arab Emirates

Latvia

see Eastern Europe

Lithuania

see Eastern Europe

Macedonia

see Eastern Europe

Malaysia (Office)

HARTING Singapore Pte Ltd
Malaysia Branch
11-02 Menara Amcorp
Jln. Persiaran Barat
46200 PJ, Sel. D. E., Malaysia
Phone +60 3 / 7955 6173
Fax +60 3 / 7955 5126
sg@HARTING.com

Montenegro

see Eastern Europe

Netherlands

HARTING B.V.
Larenweg 44
NL-5234 KA 's-Hertogenbosch
Postbus 3526
NL-5203 DM 's-Hertogenbosch
Phone +31 736 410 404
Fax +31 736 440 699
nl@HARTING.com
www.HARTINGbv.nl

New Zealand

see Australia

Norway

HARTING A/S
Østensjøveien 36, N-0667 Oslo
Phone +47 22 700 555
Fax +47 22 700 570
no@HARTING.com
www.HARTING.no

Oman

see United Arab Emirates

Philippines

see Malaysia

Poland

HARTING Polska Sp. z o. o.
ul. Kamieńskiego 201-219
PL-51-126 Wrocław
Phone +48 71 352 81 71
Fax +48 71 320 74 44
pl@HARTING.com
www.HARTING.pl

Portugal

HARTING Iberia, S. A.
Avda. Josep Tarradellas 20-30 4º 6a
E-08029 Barcelona
Phone +351 219 673 177
Fax +351 219 678 457
es@HARTING.com
www.HARTING.es/pt

Qatar

see United Arab Emirates

Republic of Moldova

see Eastern Europe

Romania

HARTING Romania SCS
Europa Unita str. 21
550018-Sibiu, Romania
Phone +40 369-102 671
Fax +40 369-102 622
ro@HARTING.com
www.HARTING.com

Russia

HARTING ZAO
Maliy Sampsoniyevsky prospect 2A
194044 Saint Petersburg, Russia
Phone +7 812 327 6477
Fax +7 812 327 6478
ru@HARTING.com
www.HARTING.ru

Saudi Arabia

see United Arab Emirates

Serbia

see Eastern Europe

Singapore

HARTING Singapore Pte Ltd.
25 International Business Park
#04-108 German Centre
Singapore 609916
Phone +65 6225 5285
Fax +65 6225 9947
sg@HARTING.com
www.HARTING.sg

Slovakia

HARTING s.r.o.
Sales office Slovakia
J. Simora 5, SK - 940 52 Nové Zámky
Phone +421 356-493 993
Fax +421 356-402 114
sk@HARTING.com
www.HARTING.sk

Slovenia

see Eastern Europe

South Africa

Cabcon Technologies (PTY) Ltd
P.O. Box 13002, Northmead, 1511
Phone +27 1184533258
Fax +27 118454077
cabcon@mweb.co.za

Spain

HARTING Iberia S.A.
Avda. Josep Tarradellas 20-30 4º 6a
E-08029 Barcelona
Phone +34 93 363 84 75
Fax +34 93 419 95 85
es@HARTING.com
www.HARTING.es

Sweden

HARTING AB
Gustavslundsvägen 141 B 4tr
S-167 51 Bromma
Phone +46 8 445 7171
Fax +46 8 445 7170
se@HARTING.com
www.HARTING.se

Switzerland

HARTING AG
Industriestrasse 26
CH-8604 Volketswil
Phone +41 44 908 20 60
Fax +41 44 908 20 69
ch@HARTING.com
www.HARTING.ch

Taiwan

HARTING Taiwan Ltd.
Room 1, 5/F
495 GuangFu South Road
RC-110 Taipei, Taiwan
Phone +886 2 2758 6177
Fax +886 2 2758 7177
tw@HARTING.com
www.HARTING.com.tw

Tajikistan

see Eastern Europe

Thailand

see Malaysia

Turkey

HARTING TURKEI Elektronik Ltd. Şti.
Barbaros Mah. Dereboyu Cad.
Fesleğen Sok.
Uphill Towers, A-1b Kat:8 D:45
34746 Ataşehir, İstanbul
Phone +90 216 688 81 00
Fax +90 216 688 81 01
tr@HARTING.com
www.HARTING.com.tr

Turkmenistan

see Eastern Europe

United Arab Emirates

HARTING Middle East FZ-LLC
Knowledge Village, Block 2A, Office F72
P.O. Box 454372, Dubai
United Arab Emirates
Tel. +971 4 453 9737
Fax +971 4 439 0339
uae@HARTING.com
www.HARTING.ae

Ukraine

see Eastern Europe

USA

HARTING Inc. of North America
1370 Bowes Road
USA-Elgin, Illinois 60123
Phone +1 (877) 741-1500 (toll free)
Fax +1 (866) 278-0307 (Inside Sales)
us@HARTING.com
www.HARTING-USA.com

Uzbekistan

see Eastern Europe

Vietnam

see Singapore

Distributors – worldwide



Farnell:
www.farnell.com

RS Components:
www.rs-components.com

FUTURE Electronics:
www.futureelectronics.com

Other countries and general contact



HARTING Electronics GmbH & Co. KG
P.O. Box 1433
32328 Espelkamp - Germany
Phone +49 5772/47-97200
Fax +49 5772/47-777
electronics@HARTING.com



Pushing Performance

www.HARTING.com