

**Major Ratings and Characteristics**

Characteristics	31DQ..	Units
$I_{F(AV)}$ Rectangular waveform	3.3	A
$V_{RRM}$	90/100	V
$I_{FSM}$ @ $t_p = 5 \mu s$ sine	210	A
$V_F$ @3Apk, $T_J = 25^\circ C$	0.85	V
$T_J$	-40 to 150	$^\circ C$

**Description/ Features**

The 31DQ.. axial leaded Schottky rectifier has been optimized for very low forward voltage drop, with moderate leakage. Typical applications are in switching power supplies, converters, free-wheeling diodes, and reverse battery protection.

- Low profile, axial leaded outline
- High purity, high temperature epoxy encapsulation for enhanced mechanical strength and moisture resistance
- Very low forward voltage drop
- High frequency operation
- Guard ring for enhanced ruggedness and long term reliability

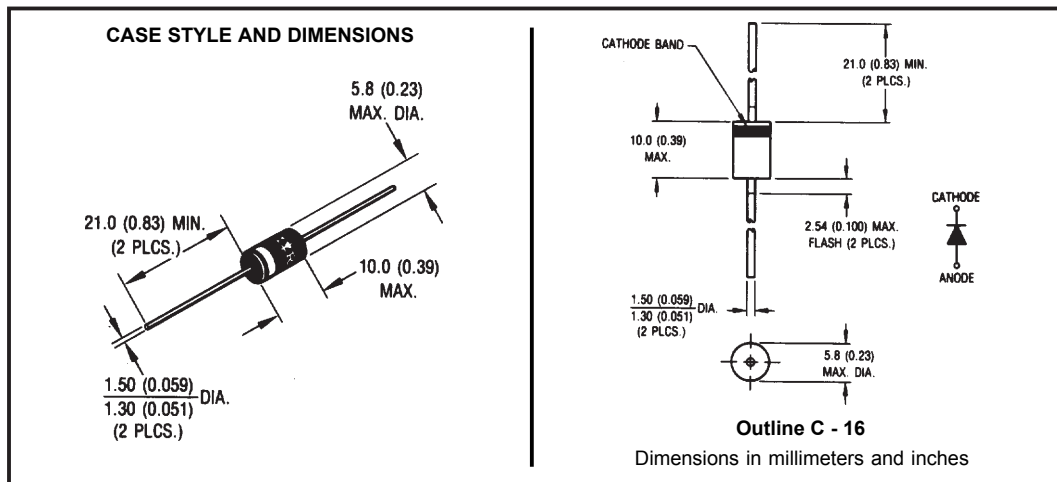

## Voltage Ratings

Part number	31DQ09	31DQ10
$V_R$ Max. DC Reverse Voltage (V)	90	100
$V_{RWM}$ Max. Working Peak Reverse Voltage (V)		

## Absolute Maximum Ratings

Parameters	31DQ..	Units	Conditions
$I_{F(AV)}$ Max. Average Forward Current * See Fig. 4	3.3	A	50% duty cycle @ $T_C = 53.4^\circ\text{C}$ , rectangular wave form
$I_{FSM}$ Max. Peak One Cycle Non-Repetitive Surge Current * See Fig. 6	210	A	Following any rated load condition and with rated $V_{RRM}$ applied
	34		
$E_{AS}$ Non-Repetitive Avalanche Energy	3.0	mJ	$T_J = 25^\circ\text{C}$ , $I_{AS} = 1.0$ Amps, $L = 6$ mH
$I_{AR}$ Repetitive Avalanche Current	0.5	A	Current decaying linearly to zero in 1 $\mu\text{sec}$ Frequency limited by $T_J$ max. $V_A = 1.5 \times V_R$ typical

## Electrical Specifications

Parameters	31DQ..	Units	Conditions
$V_{FM}$ Max. Forward Voltage Drop * See Fig. 1 (1)	0.85	V	@ 3A $T_J = 25^\circ\text{C}$
	0.97	V	@ 6A
	0.69	V	@ 3A $T_J = 125^\circ\text{C}$
	0.80	V	@ 6A
$I_{RM}$ Max. Reverse Leakage Current * See Fig. 2 (1)	1	mA	$T_J = 25^\circ\text{C}$
	3	mA	$T_J = 125^\circ\text{C}$ $V_R = \text{rated } V_R$
$C_T$ Typical Junction Capacitance	110	pF	$V_R = 5V_{DC}$ (test signal range 100Khz to 1Mhz) $25^\circ\text{C}$
$L_S$ Typical Series Inductance	9.0	nH	Measured lead to lead 5mm from package body
dv/dt Max. Voltage Rate of Change	10000	V/ $\mu\text{s}$	(Rated $V_R$ )

(1) Pulse Width < 300 $\mu\text{s}$ , Duty Cycle <2%

## Thermal-Mechanical Specifications

Parameters	31DQ..	Units	Conditions
$T_J$ Max. Junction Temperature Range	-40 to 150	$^\circ\text{C}$	
$T_{stg}$ Max. Storage Temperature Range	-40 to 150	$^\circ\text{C}$	
$R_{thJA}$ Max. Thermal Resistance Junction to Ambient	80	$^\circ\text{C}/\text{W}$	DC operation Without cooling fins
$R_{thJL}$ Typical Thermal Resistance Junction to Lead	34	$^\circ\text{C}/\text{W}$	DC operation
wt Approximate Weight	1.2 (0.042)	g (oz.)	
Case Style	C - 16		

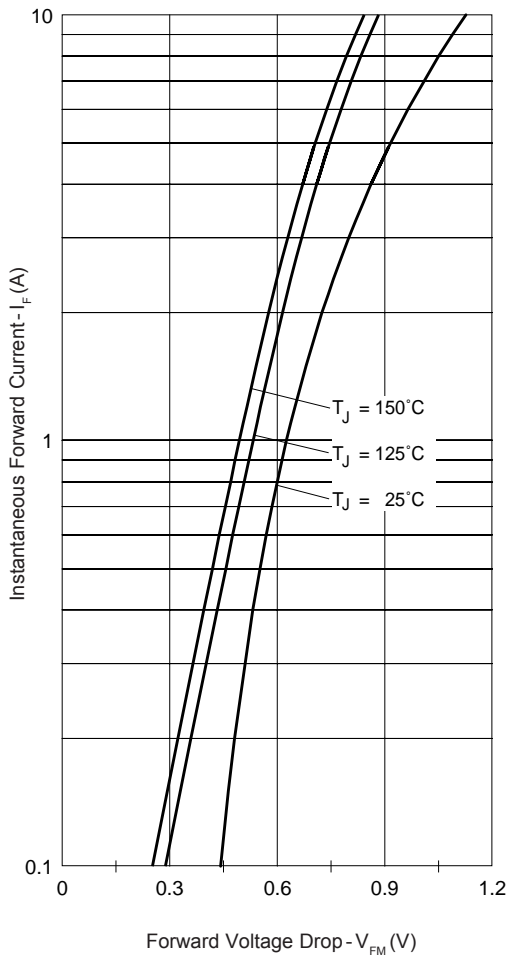

**Fig. 1 - Max. Forward Voltage Drop Characteristics**

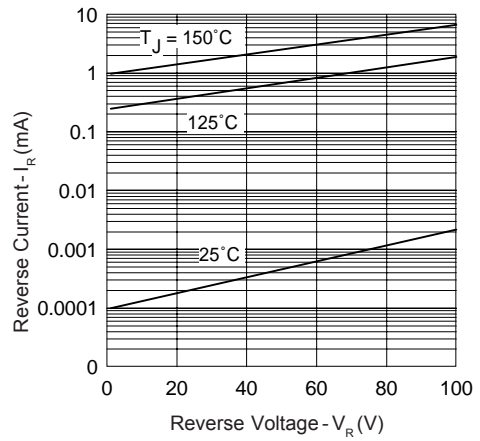

**Fig. 2 - Typical Values Of Reverse Current Vs. Reverse Voltage**

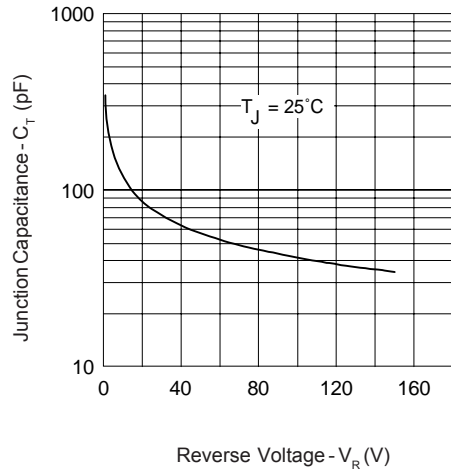

**Fig. 3 - Typical Junction Capacitance Vs. Reverse Voltage**

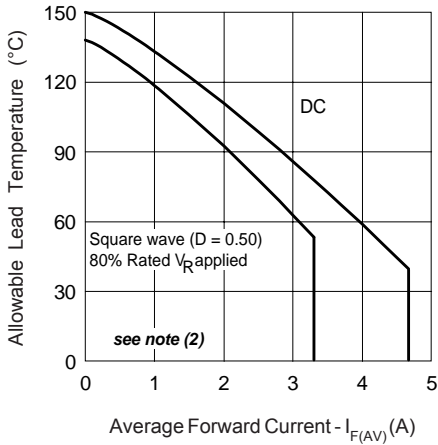

**Fig. 4 - Max. Allowable Lead Temperature Vs. Average Forward Current**

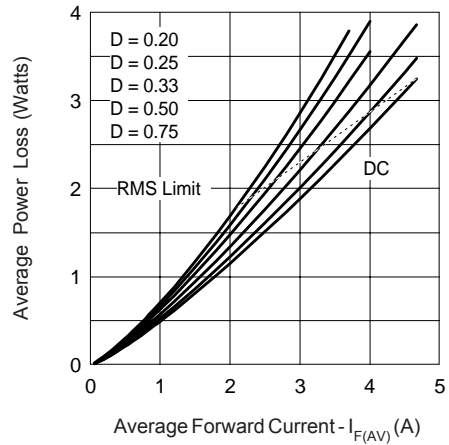

**Fig. 5 - Forward Power Loss Characteristics**

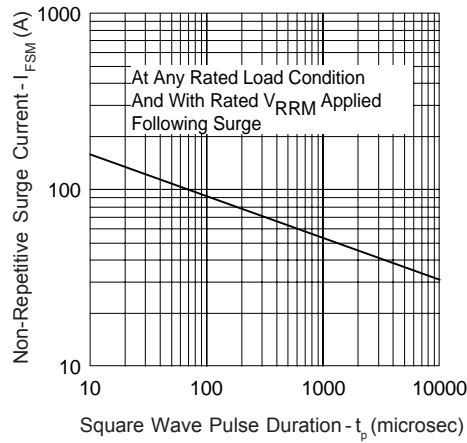

**Fig. 6 - Max. Non-Repetitive Surge Current**

(2) Formula used:  $T_C = T_J - (P_d + P_{d_{REV}}) \times R_{thJC}$ ;  
 $P_d = \text{Forward Power Loss} = I_{F(AV)} \times V_{FM} @ (I_{F(AV)} / D)$  (see Fig. 6);  
 $P_{d_{REV}} = \text{Inverse Power Loss} = V_{R1} \times I_R (1 - D)$ ;  $I_R @ V_{R1} = 80\% \text{ rated } V_R$

Ordering Information Table

Device Code											
	<table border="1" style="margin: auto;"> <tr> <td style="padding: 5px;">31</td> <td style="padding: 5px;">D</td> <td style="padding: 5px;">Q</td> <td style="padding: 5px;">10</td> <td style="padding: 5px;">TR</td> </tr> <tr> <td style="text-align: center;">①</td> <td style="text-align: center;">②</td> <td style="text-align: center;">③</td> <td style="text-align: center;">④</td> <td style="text-align: center;">⑤</td> </tr> </table>	31	D	Q	10	TR	①	②	③	④	⑤
31	D	Q	10	TR							
①	②	③	④	⑤							
<b>1</b>	- 31 = 3.3A (Axial and small packages - Current is x10)										
<b>2</b>	- D = DO-41 package										
<b>3</b>	- Q = Schottky Q.. Series										
<b>4</b>	- 10 = Voltage Ratings										
<b>5</b>	- TR= Tape & Reel package (1200 pcs)										
	- = Box package (500 pcs)										

10 = 100V
09 = 90V

```

31DQ10
*****
* SPICE Model Diode *
*****
.SUBCKT 31DQ10 ANO CAT
D1 ANO 1 CAT
*Define diode model
.MODEL DMOD D(Is=56.46E-06 N=2.202 Rs=28.27E-03 Ikf=0.5957 Xti=2 Eg=1.11
+ Cjo=199.3E-12 M=0.4572 Vj=1.873 Fc=0.5 Isr=165.6E-24 Nr=4.955
+ Bv=119.9 Ibv=215.5E-06 Tt=21.64E-09)
*****
.ENDS 31DQ10
    
```

Data and specifications subject to change without notice.  
 This product has been designed and qualified for Industrial Level.  
 Qualification Standards can be found on IR's Web site.