

LOW FREQUENCY POWER AMPLIFIER

FEATURES

- *Low frequency power amplifier
- *Complement to 2SB562

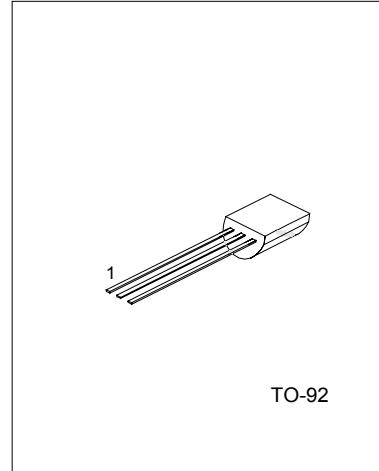

1:EMITTER 2:COLLECTOR 3:BASE

ABSOLUTE MAXIMUM RATINGS (Ta=25°C, unless otherwise specified)

PARAMETER	SYMBOL	VALUE	UNIT
Collector-Base Voltage	V _{CB0}	25	V
Collector-Emitter Voltage	V _{CEO}	20	V
Emitter-Base Voltage	V _{EBO}	5	V
Collector Current	I _c	1	A
Collector Peak Current	I _{c(peak)}	1.5	A
Collector Power Dissipation	P _c	0.9	W
Junction Temperature	T _j	150	°C
Storage Temperature	T _{STG}	-55 ~ +150	°C

ELECTRICAL CHARACTERISTICS (Ta=25°C, unless otherwise specified)

PARAMETER	SYMBOL	TEST CONDITIONS	MIN	TYP	MAX	UNIT
Collector to base breakdown voltage	V _{(BR)CBO}	I _c =10μA, I _E =0	25			V
Collector to emitter breakdown voltage	V _{(BR)CEO}	I _c =1mA, R _{BE} =∞	20			V
Emitter to base breakdown voltage	V _{(BR)EBO}	I _E =10μA, I _C =0	5			V
Collector Cut-Off Current	I _{CBO}	V _{CB} =20V, I _E =0			1	μA
DC Current transfer ratio	h _{FE}	V _{CE} =2V, I _c =0.5A (note)	85		240	
Collector to emitter saturation voltage	V _{CE(sat)}	I _c =0.8A, I _B =0.08A (note)		0.2	0.5	V
Base to emitter voltage	V _{BE}	V _{CE} =2V, I _c =0.5A (note)		0.79	1	V
Gain bandwidth product	f _T	V _{CE} =2V, I _c =0.5A (note)		190		MHz
Collector output capacitance	C _{ob}	V _{CB} =10V, I _E =0, f=1MHz		22		pF

Note: Pulse test

CLASSIFICATION OF hFE

RANK	B	C
RANGE	85 - 170	120 - 240

TYPICAL PERFORMANCE CHARACTERISTICS

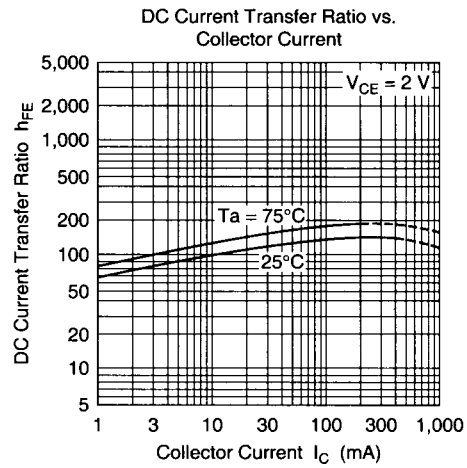
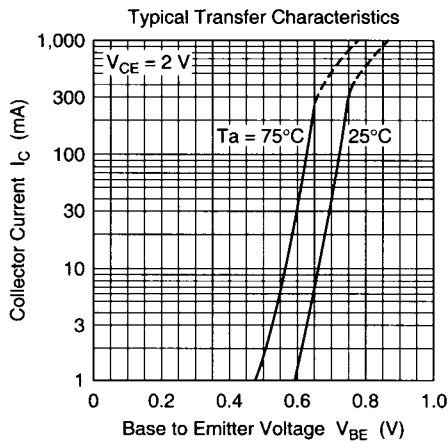
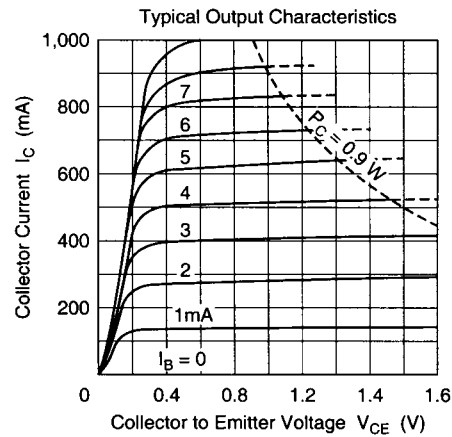
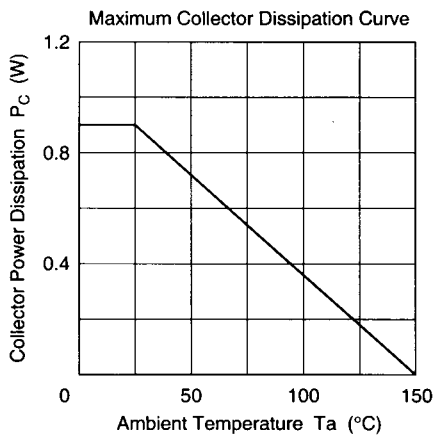

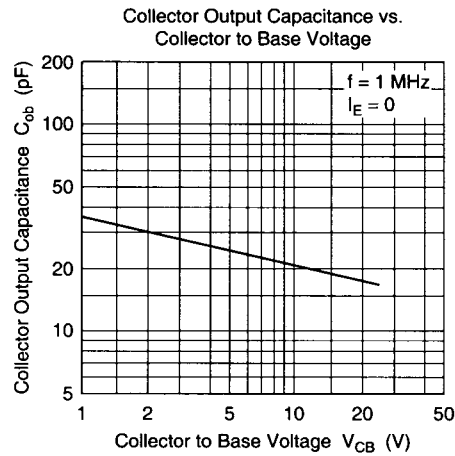
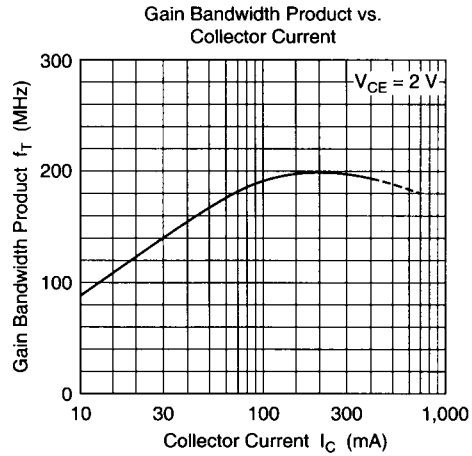
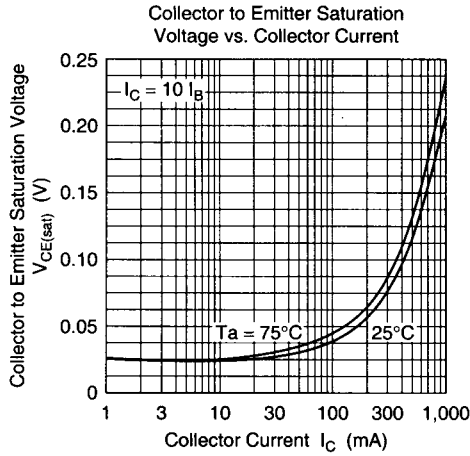

UTC assumes no responsibility for equipment failures that result from using products at values that exceed, even momentarily, rated values (such as maximum ratings, operating condition ranges, or other parameters) listed in products specifications of any and all UTC products described or contained herein. UTC products are not designed for use in life support appliances, devices or systems where malfunction of these products can be reasonably expected to result in personal injury. Reproduction in whole or in part is prohibited without the prior written consent of the copyright owner. The information presented in this document does not form part of any quotation or contract, is believed to be accurate and reliable and may be changed without notice.