

Silicon NPN Epitaxial Planar Transistor (Complement to type 2SA1860)

Application : Audio and General Purpose

Absolute maximum ratings (Ta=25°C)

Symbol	2SC4886	Unit
Vcbo	150	V
Vceo	150	V
Vebo	5	V
Ic	14	A
Ib	3	A
Pc	80(Tc=25°C)	W
Tj	150	°C
Tstg	-55 to +150	°C

Electrical Characteristics (Ta=25°C)

Symbol	Conditions	2SC4886	Unit
Icbo	VcB=150V	100max	μA
IEBO	VEB=5V	100max	μA
V(BR)CEO	Ic=25mA	150min	V
hFE	VCE=4V, Ic=5A	50min*	
VCE(sat)	Ic=5A, Ib=500mA	2.0max	V
fr	VCE=12V, IE=-2A	60typ	MHz
COB	VcB=10V, f=1MHz	200typ	pF

*hFE Rank O(50 to 100), P(70 to 140), Y(90 to 180)

Typical Switching Characteristics (Common Emitter)

Vcc (V)	RL (Ω)	Ic (A)	VBB1 (V)	VBB2 (V)	Ib1 (A)	Ib2 (A)	ton (μs)	tstg (μs)	tr (μs)
60	12	5	10	-5	0.5	-0.5	0.26typ	1.5typ	0.35typ

External Dimensions FM100(TO3PF)

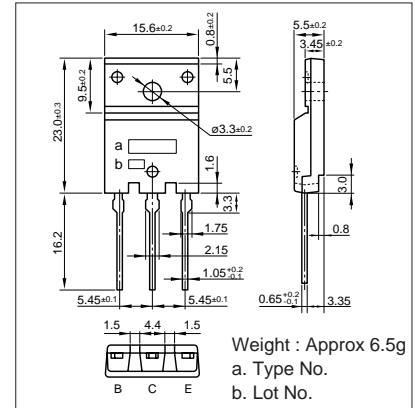

Ic-VCE Characteristics (Typical)

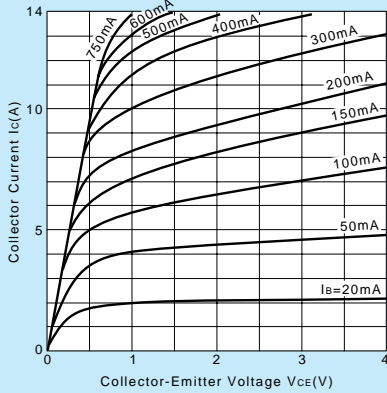

VCE(sat)-Ib Characteristics (Typical)

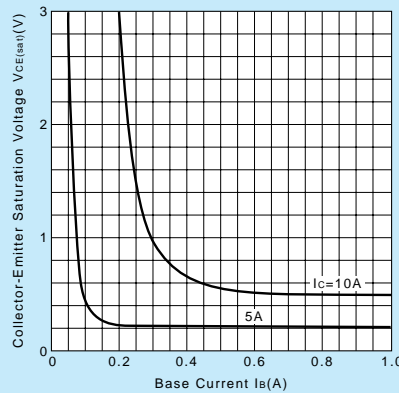

Ic-VBE Temperature Characteristics (Typical)

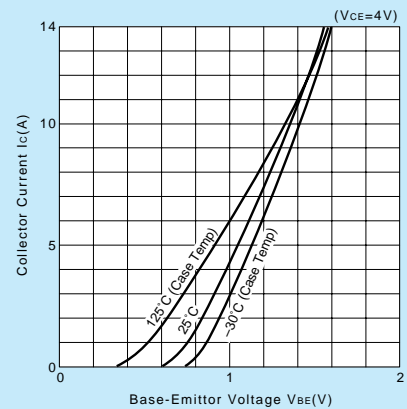

hFE-Ic Characteristics (Typical)

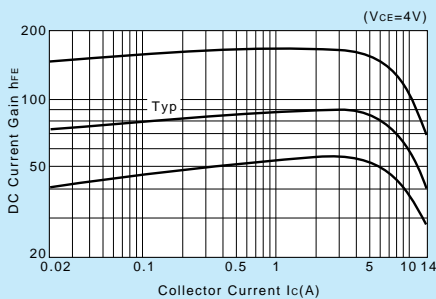

hFE-Ic Temperature Characteristics (Typical)

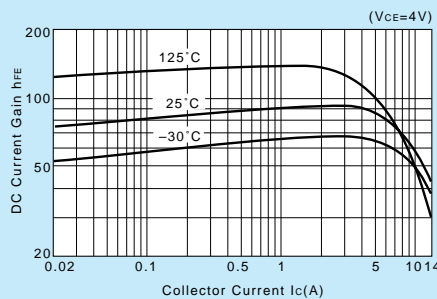

θj-a-t Characteristics

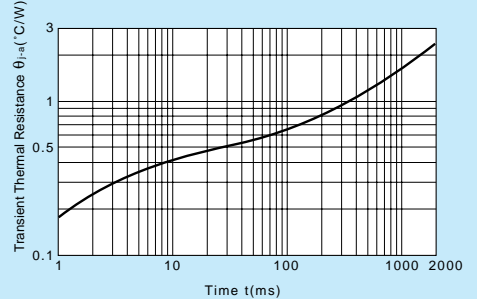

fr-IE Characteristics (Typical)

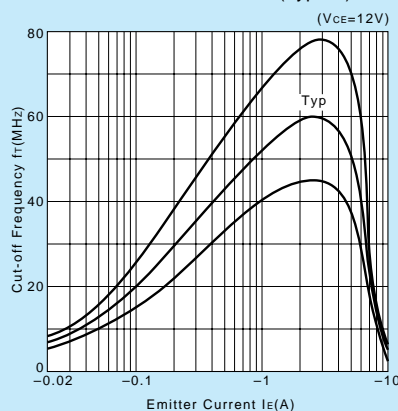

Safe Operating Area (Single Pulse)

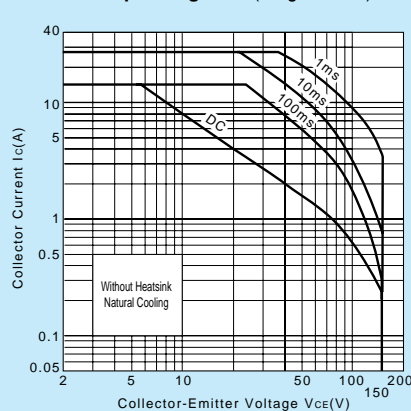

Pc-Ta Derating

