

## Silicon Epitaxial Planar Transistor

## 2SC4177W

### FEATURES

- Excellent  $h_{FE}$  linearity.
- High voltage and current.
- Complementary to 2SA1611.
- Small package.

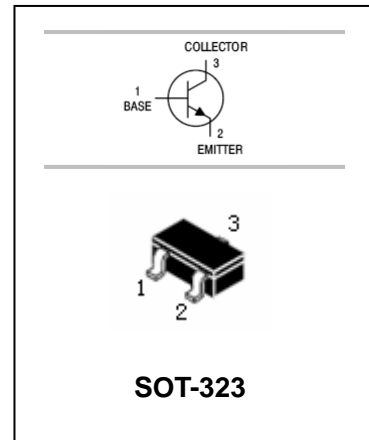

### APPLICATIONS

- Audio frequency general purpose amplifier.

### ORDERING INFORMATION

Type No.	Marking	Package Code
2SC4177W	L4•//L5•/L6•/L7•	SOT-323

### MAXIMUM RATING @ $T_a=25^{\circ}\text{C}$ unless otherwise specified

Symbol	Parameter	Value	Units
$V_{CBO}$	Collector-Base Voltage	60	V
$V_{CEO}$	Collector-Emitter Voltage	50	V
$V_{EBO}$	Emitter-Base Voltage	5	V
$I_C$	Collector Current -Continuous	100	mA
$P_C$	Collector Dissipation	150	mW
$T_j, T_{stg}$	Junction and Storage Temperature	-55~150	$^{\circ}\text{C}$

### ELECTRICAL CHARACTERISTICS @ $T_a=25^{\circ}\text{C}$ unless otherwise specified

## Silicon Epitaxial Planar Transistor

## 2SC4177W

Parameter	Symbol	Test conditions	MIN	TYP	MAX	UNIT
Collector-base breakdown voltage	$V_{(BR)CBO}$	$I_C=100\mu A, I_E=0$	60			V
Collector-emitter breakdown voltage	$V_{(BR)CEO}$	$I_C=1mA, I_B=0$	50			V
Emitter-base breakdown voltage	$V_{(BR)EBO}$	$I_E=100\mu A, I_C=0$	5			V
Collector cut-off current	$I_{CBO}$	$V_{CB}=60V, I_E=0$			0.1	$\mu A$
Emitter cut-off current	$I_{EBO}$	$V_{EB}=5V, I_C=0$			0.1	$\mu A$
DC current gain	$h_{FE}$	$V_{CE}=6V, I_C=1mA$	90	200	600	
Collector-emitter saturation voltage	$V_{CE(sat)}$	$I_C=100mA, I_B=10mA$		0.15	0.3	V
Base-emitter saturation voltage	$V_{BE(sat)}$	$I_C=100mA, I_B=10mA$		0.86	1.0	V
Transition frequency	$f_T$	$V_{CE}=6V, I_E=-10mA$		250		MHz
Collector output capacitance	$C_{ob}$	$V_{CB}=6V, I_E=0, f=1MHz$		3.0		pF

### CLASSIFICATION OF $h_{FE}$

Range	90-180	135-270	200-400	300-600
Marking	L4	L5	L6	L7

### TYPICAL CHARACTERISTICS @ $T_a=25^\circ C$ unless otherwise specified

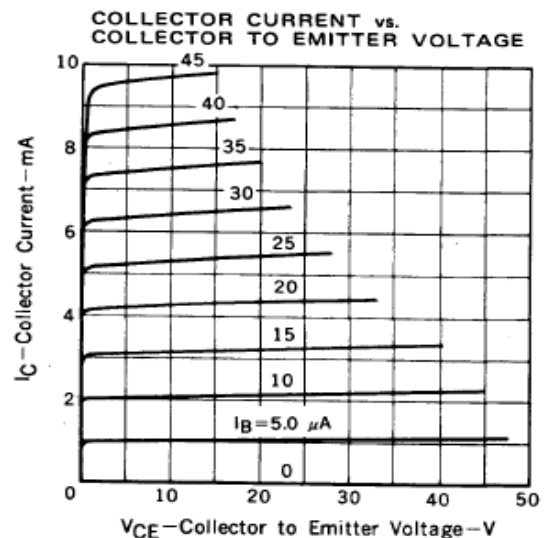
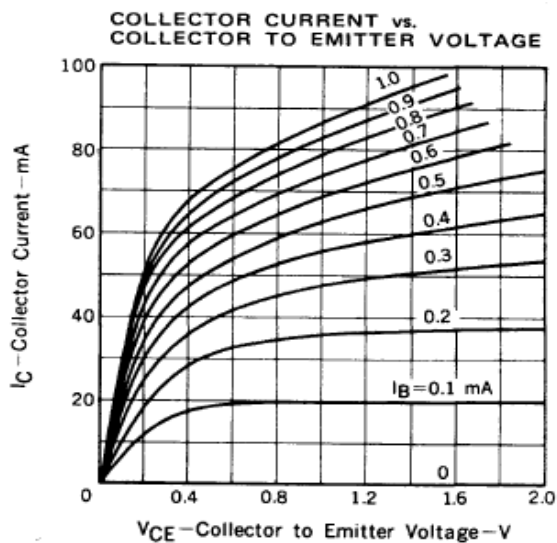

## Silicon Epitaxial Planar Transistor

## 2SC4177W

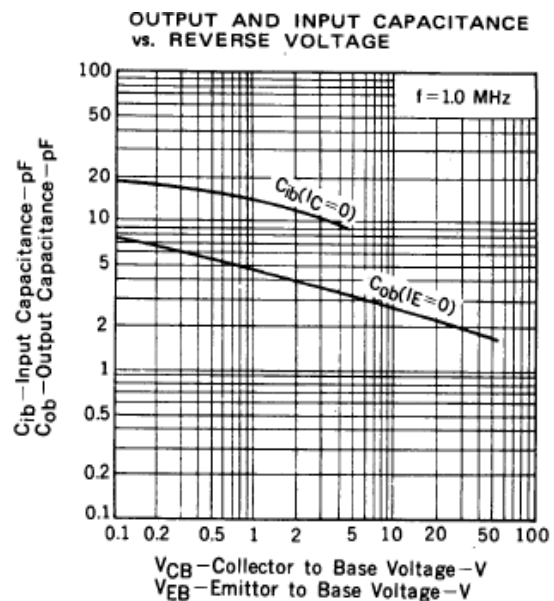
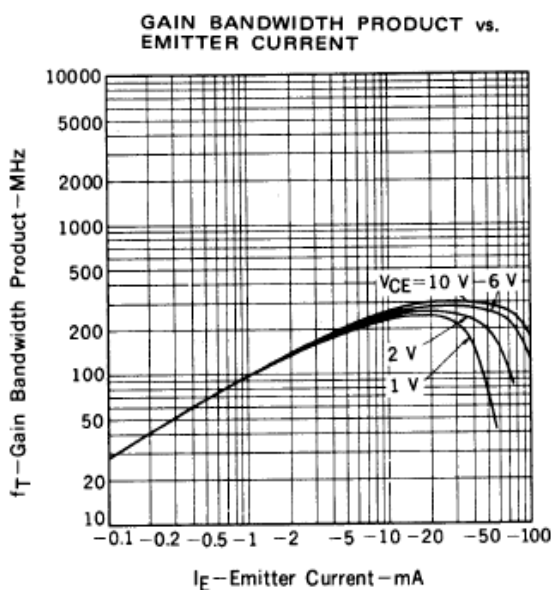
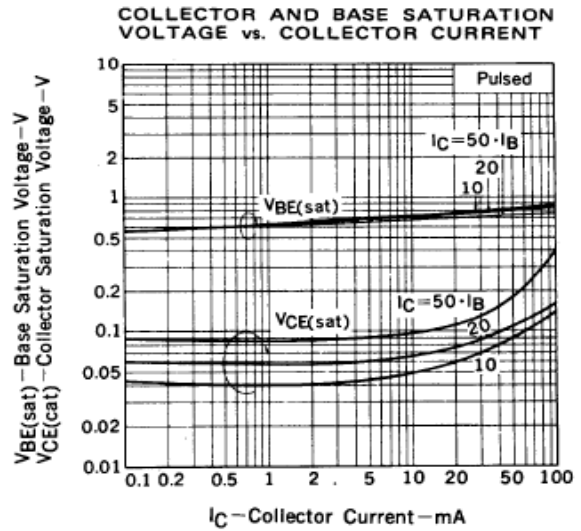
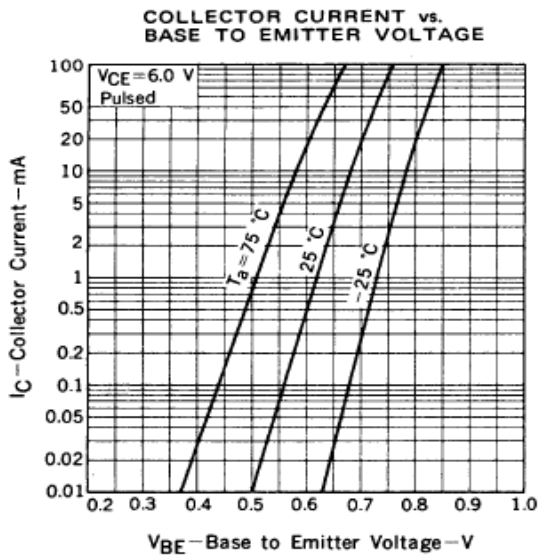
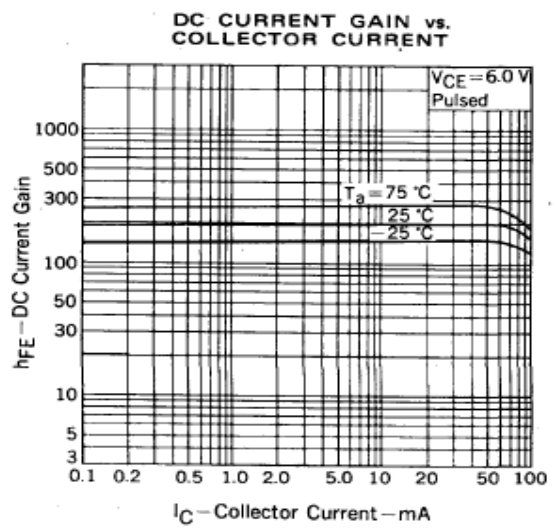
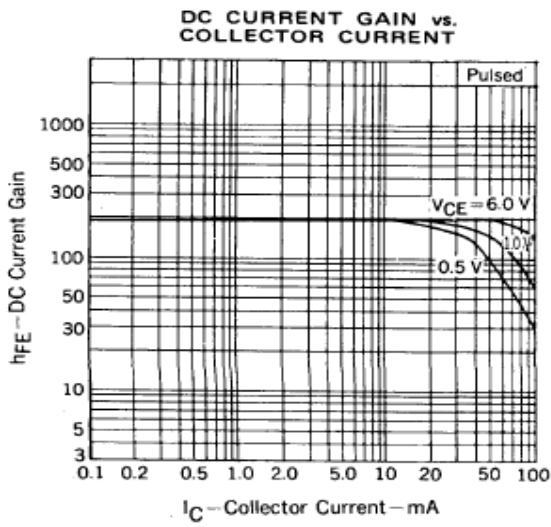

## Silicon Epitaxial Planar Transistor

## 2SC4177W

### PACKAGE OUTLINE

Plastic surface mounted package

SOT-323

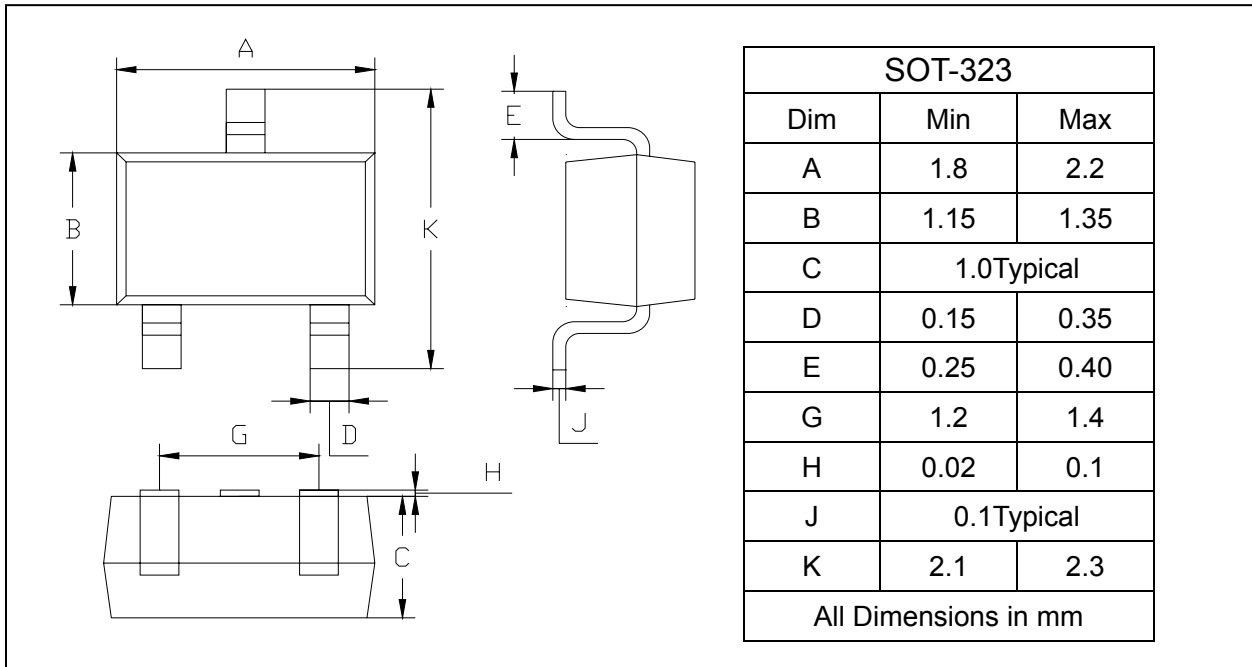

### PACKAGE INFORMATION

Device	Package	Shipping
2SC4177W	SOT-323	3000/Tape&Reel