

# MITSUBISHI RF POWER TRANSISTOR 2SC3908

## NPN EPITAXIAL PLANAR TYPE

### DESCRIPTION

2SC3908 is a silicon NPN epitaxial planar type transistor designed for HF power amplifiers applications.

### FEATURES

- High power gain:  $G_{pe} \geq 11.5\text{dB}$   
@ $P_O = 100\text{W}$ ,  $f = 30\text{MHz}$ ,  $V_{CC} = 12.5\text{V}$
- The ability withstand infinite VSWR when operated at  $f = 30\text{MHz}$ ,  $V_{CC} = 12.5\text{V}$ ,  $P_O = 100\text{W}$ .
- Flange type ceramic package.

### APPLICATION

For output stage of 100 – 150W power amplifiers in HF band SSB mobile radio sets. (Push-pull operation)

### OUTLINE DRAWING

Dimensions in mm

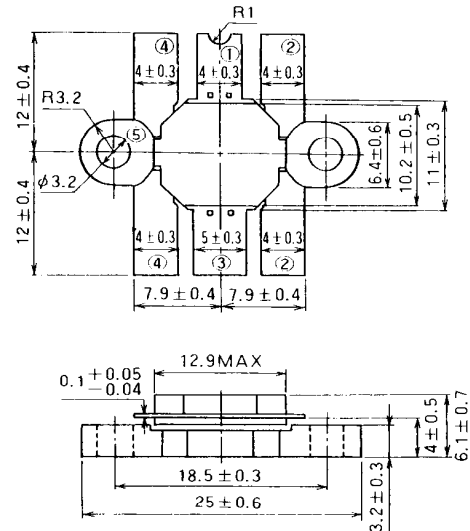

PIN :

- (1) COLLECTOR
- (2) EMITTER (FLANGE)
- (3) BASE
- (4) EMITTER (FLANGE)
- (5) FIN (EMITTER)

T-40E

### ABSOLUTE MAXIMUM RATINGS ( $T_C = 25^\circ\text{C}$ unless otherwise specified)

Symbol	Parameter	Conditions	Rating	Unit
$V_{CBO}$	Collector to base voltage		50	V
$V_{EBO}$	Emitter to base voltage		5	V
$V_{CEO}$	Collector to emitter voltage	$R_{BE} = \infty$	20	V
$I_C$	Collector current		22	A
$P_C$	Collector dissipation	$T_a = 25^\circ\text{C}$	7.8	W
		$T_C = 25^\circ\text{C}$	200	W
$T_j$	Junction temperature		175	$^\circ\text{C}$
$T_{stg}$	Storage temperature		-55 to 175	$^\circ\text{C}$
$R_{th-a}$	Thermal resistance		19.2	$^\circ\text{C}/\text{W}$
$R_{th-c}$			0.75	$^\circ\text{C}/\text{W}$

Note. Above parameters are guaranteed independently.

### ELECTRICAL CHARACTERISTICS ( $T_C = 25^\circ\text{C}$ unless otherwise specified)

Symbol	Parameter	Test conditions	Limits			Unit
			Min	Typ	Max	
$V_{(BR)EBO}$	Emitter to base breakdown voltage	$I_C = 20\text{mA}$ , $I_E = 0$	50			V
$V_{(BR)CBO}$	Collector to base breakdown voltage	$I_E = 20\text{mA}$ , $I_C = 0$	5			V
$V_{(BR)CEO}$	Collector to emitter breakdown voltage	$I_C = 0.1\text{A}$ , $R_{BE} = \infty$	20			V
$I_{CBO}$	Collector cutoff current	$V_{CB} = 15\text{V}$ , $I_E = 0$			5	mA
$I_{EBO}$	Emitter cutoff current	$V_{EB} = 3\text{V}$ , $I_C = 0$			5	mA
$h_{FE}$	DC forward current gain	$V_{CE} = 10\text{V}$ , $I_C = 1\text{A}$	10	50	180	—
$P_O$	Output power	$f = 30\text{MHz}$ , $V_{CC} = 12.5\text{V}$ , $P_{in} = 7\text{W}$	100	110		W
$\eta_C$	Collector efficiency		55	60		%

Note. \* Pulse test,  $P_W = 150\mu\text{s}$ , duty = 5%.

Above parameters, ratings, limits and conditions are subject to change.

**NPN EPITAXIAL PLANAR TYPE**

**TEST CIRCUIT**

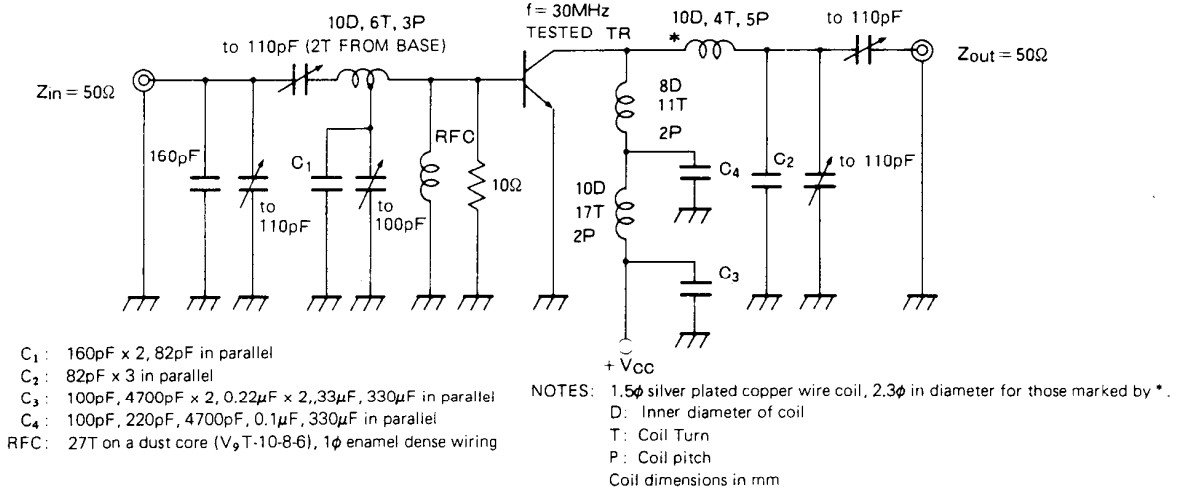

**TYPICAL PERFORMANCE DATA**

**COLLECTOR DISSIPATION VS. AMBIENT TEMPERATURE**

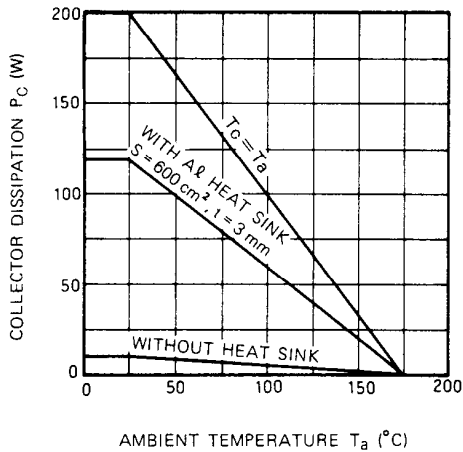

**COLLECTOR CURRENT VS. COLLECTOR TO EMITTER VOLTAGE**

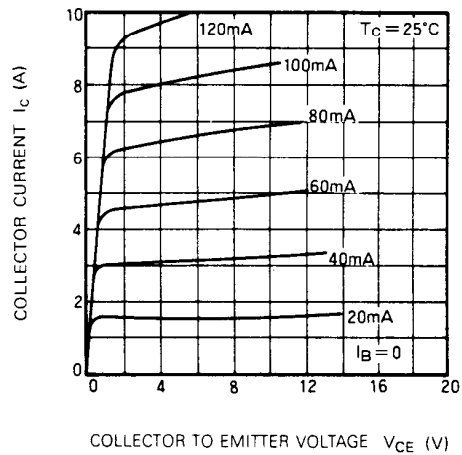

**COLLECTOR TO EMITTER BREAKDOWN VOLTAGE VS. BASE TO EMITTER RESISTANCE**

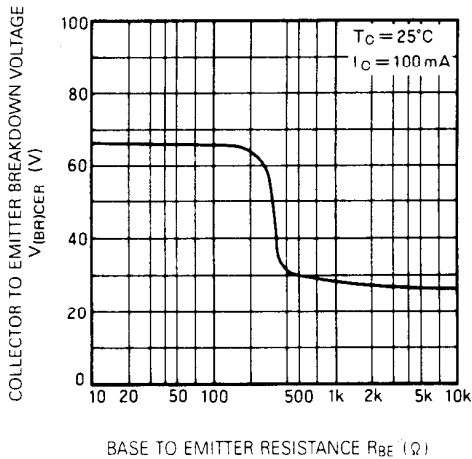

**DC CURRENT GAIN VS. COLLECTOR CURRENT**

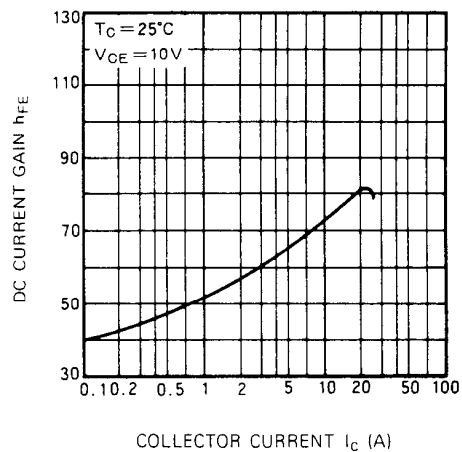

MITSUBISHI RF POWER TRANSISTOR  
**2SC3908**

**NPN EPITAXIAL PLANAR TYPE**

**COLLECTOR OUTPUT CAPACITANCE VS. COLLECTOR TO BASE VOLTAGE**

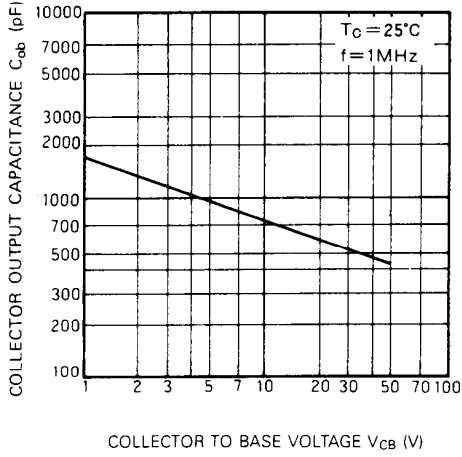

**OUTPUT POWER, COLLECTOR EFFICIENCY VS. INPUT POWER**

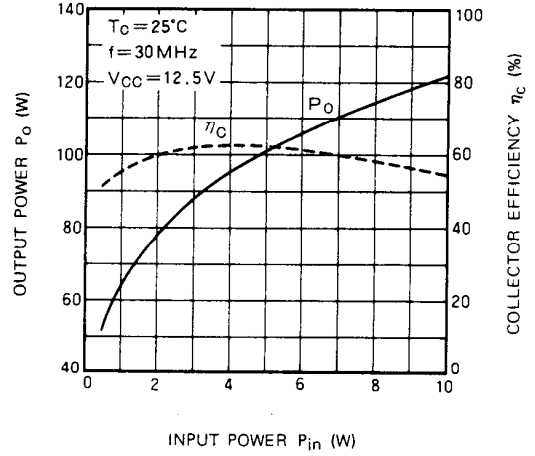

**OUTPUT POWER, COLLECTOR SUPPLY VOLTAGE VARIATION**

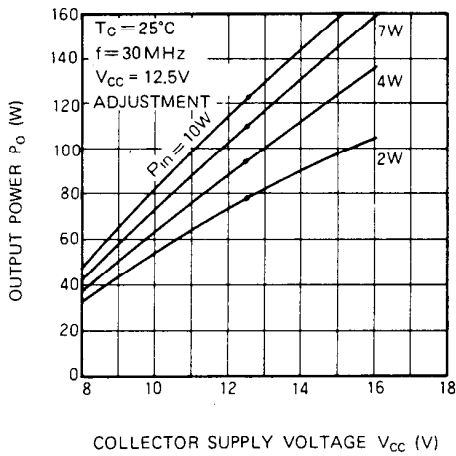

**NPN EPITAXIAL PLANAR TYPE**

**PRECAUTIONS FOR USE**

Mitsubishi transistors have high reliability and good performance, as they are designed and manufactured under strict quality control. However, the characteristics and reliability of semiconductor devices are greatly affected by usage conditions if inappropriate thermal, mechanical or electrical stresses are applied.

To keep high reliability and obtain good performance when using Mitsubishi transistors, the following important points should be noted before use:

**1. OPERATING JUNCTION TEMPERATURE**

$T_{j(OP)}$

When designing a heat sink, keep the operating junction temperature  $T_{j(OP)}$  below  $130^{\circ}\text{C}$  at ambient temperature  $T_a = 60^{\circ}\text{C}$ .

**2. BASE-EMITTER EXTERNALLY CONNECTED RESISTOR**

If a base-emitter bias resistor is inserted for AB class or C class amplifiers, the resistance value should be minimized. (Normally less than  $5\Omega$  to  $10\Omega$ .) If this value is too large, exciting input is increased and reverse bias current is applied to base and emitter and the emitter-base junction breaks down because of this exciting input, thus reducing  $h_{FE}$  and output power.

**3. MOUNTING METHOD**

- (1) Use fastening screws of M3 x 0.5.
- (2) Fastening torque of screw is recommended as 5 to 6 kg-cm.
- (3) Application of compound: Thermal compound to get good heat sinking should be applied to the bottom of the flange, fastening screws, as well as inside flange holes and holes of module's fin.

- (4) The distance between the centers of screw holes of heat sink fins should be  $18.3 \pm 0.2\text{mm}$  and the diameter of holes should be 3.5 mm.
- (5) When mounting the device to the substrate, do not apply upper tensile force to the leads.
- (6) The temperature of lead soldering should be less than  $250^{\circ}\text{C}$  and shorter than 8 seconds.

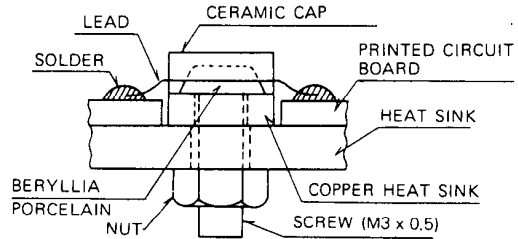

**4. GUARANTEED CHARACTERISTICS**

All the graphic characteristics illustrated in this catalog are typical examples. The characteristics of individual devices as specified in the tables of absolute maximum ratings and electrical characteristics are guaranteed under the specified conditions.

**5. PROCESSING OF DEFECTIVE PRODUCT OR DISCARDED PRODUCT**

Beryllia porcelain is used in the transistor package. Dust or vapor of beryllia porcelain is extremely harmful to you. Do not cut, crack, or carve the device or do not process the device at high temperature (more than  $800^{\circ}\text{C}$ ) in humid atmosphere.