

## Silicon Epitaxial Planar Transistor

## 2SC3356W

### FEATURES

- Low noise and high gain:  $NF=1.1\text{dB TYP}$ ,  
 $G_a=11\text{dB TYP}$ . @ $V_{CE}=10\text{V}$ ,  $I_C=7\text{mA}$ ,  $f=1.0\text{GHz}$   Lead-free
- High power gain:  $MAG=13\text{dB TYP}$ .  
@ $V_{CE}=10\text{V}$ ,  $I_C=20\text{mA}$ ,  $f=1.0\text{GHz}$

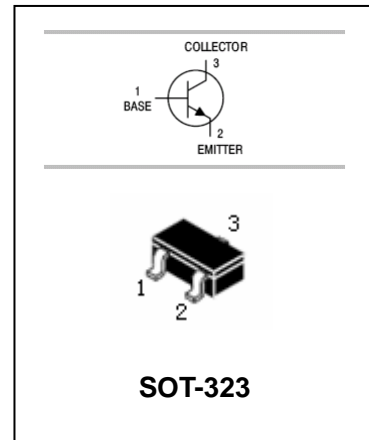

### APPLICATIONS

- NPN Silicon Epitaxial Planar Transistor.

### ORDERING INFORMATION

Type No.	Marking	Package Code
2SC3356W	R23/R24/R25	SOT-323

### MAXIMUM RATING @ $T_a=25^\circ\text{C}$ unless otherwise specified

Symbol	Parameter	Value	Units
$V_{CBO}$	Collector-Base Voltage	20	V
$V_{CEO}$	Collector-Emitter Voltage	12	V
$V_{EBO}$	Emitter-Base Voltage	3	V
$I_C$	Collector Current -Continuous	100	mA
$P_C$	Collector Dissipation	200	mW
$T_j, T_{stg}$	Junction and Storage Temperature	-55~150	$^\circ\text{C}$

**Silicon Epitaxial Planar Transistor****2SC3356W****ELECTRICAL CHARACTERISTICS @ Ta=25°C unless otherwise specified**

Parameter	Symbol	Test conditions	MIN	TYP	MAX	UNIT
Collector-base breakdown voltage	$V_{(BR)CBO}$	$I_C=10\mu A, I_E=0$	20			V
Collector-emitter breakdown voltage	$V_{(BR)CEO}$	$I_C=1mA, I_B=0$	12			V
Emitter-base breakdown voltage	$V_{(BR)EBO}$	$I_E=10\mu A, I_C=0$	3			V
Collector cut-off current	$I_{CBO}$	$V_{CB}=10V, I_E=0$			0.1	$\mu A$
Emitter cut-off current	$I_{EBO}$	$V_{EB}=1V, I_C=0$			0.1	$\mu A$
DC current gain	$h_{FE}$	$V_{CE}=10V, I_C=20mA$	50		300	
Transition frequency	$f_T$	$V_{CE}=10V, I_C=20mA$		6		GHz
Noise figure	F	$V_{CE}=10V, I_C=7mA, f=1GHz$			2	dB

**CLASSIFICATION OF  $h_{FE(1)}$** 

Rank	Q	R	S
Range	50-100	80-160	125-250
Marking	R23	R24	R25

## Silicon Epitaxial Planar Transistor

## 2SC3356W

TYPICAL CHARACTERISTICS @  $T_a=25^\circ\text{C}$  unless otherwise specified

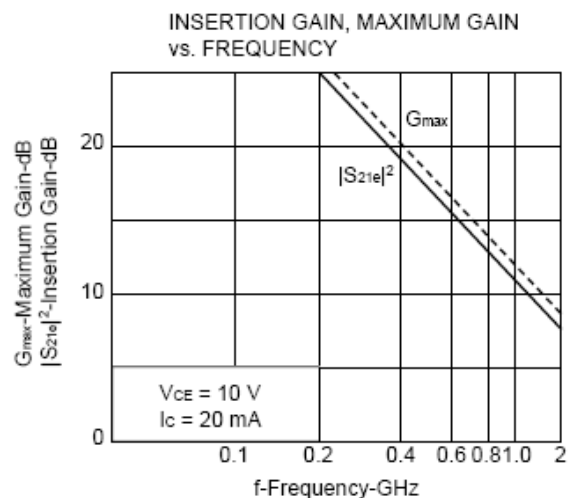
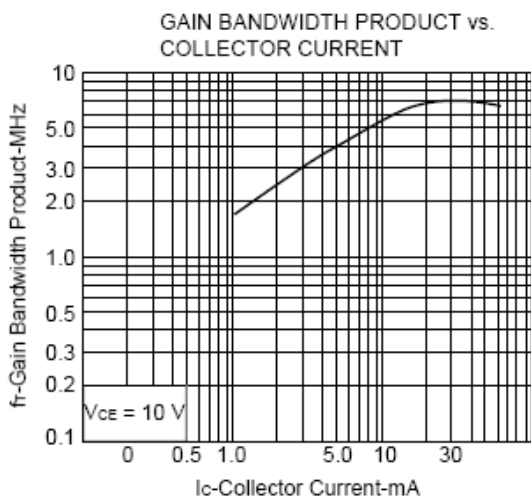
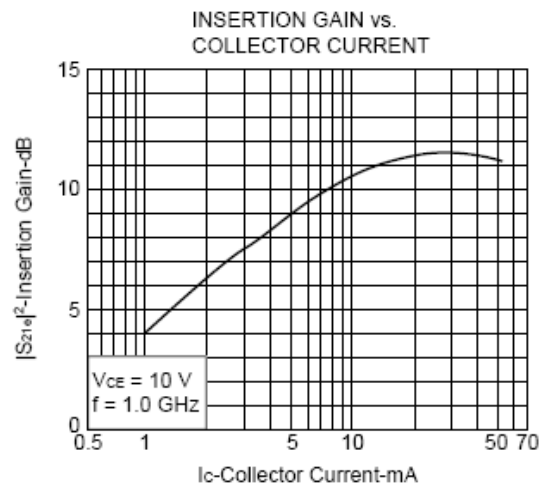
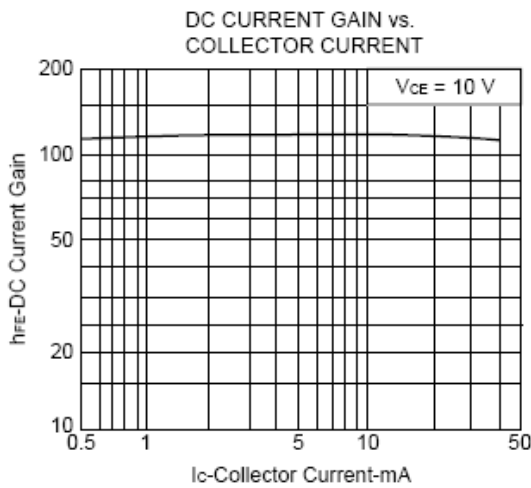
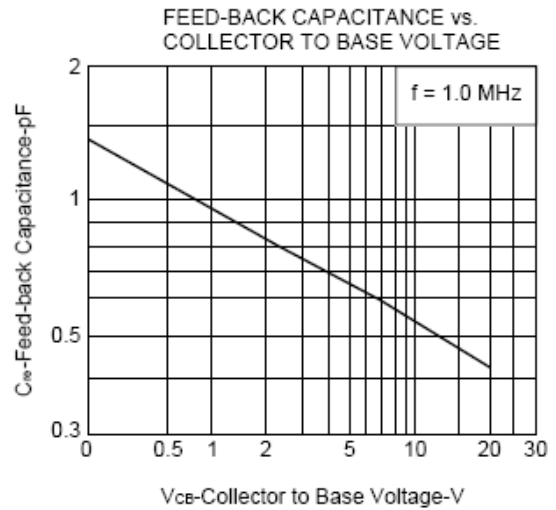
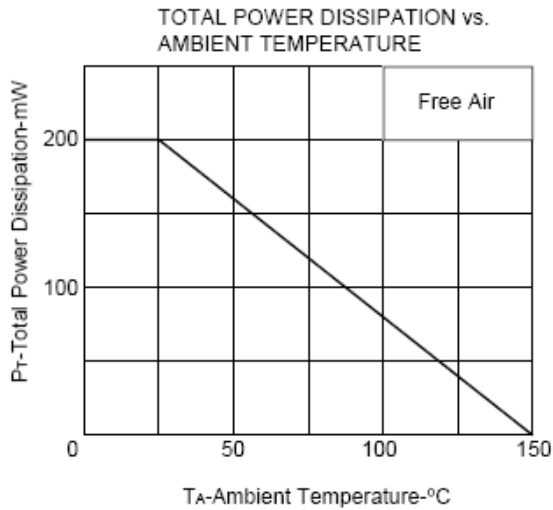

## Silicon Epitaxial Planar Transistor

## 2SC3356W

### PACKAGE OUTLINE

Plastic surface mounted package

SOT-323

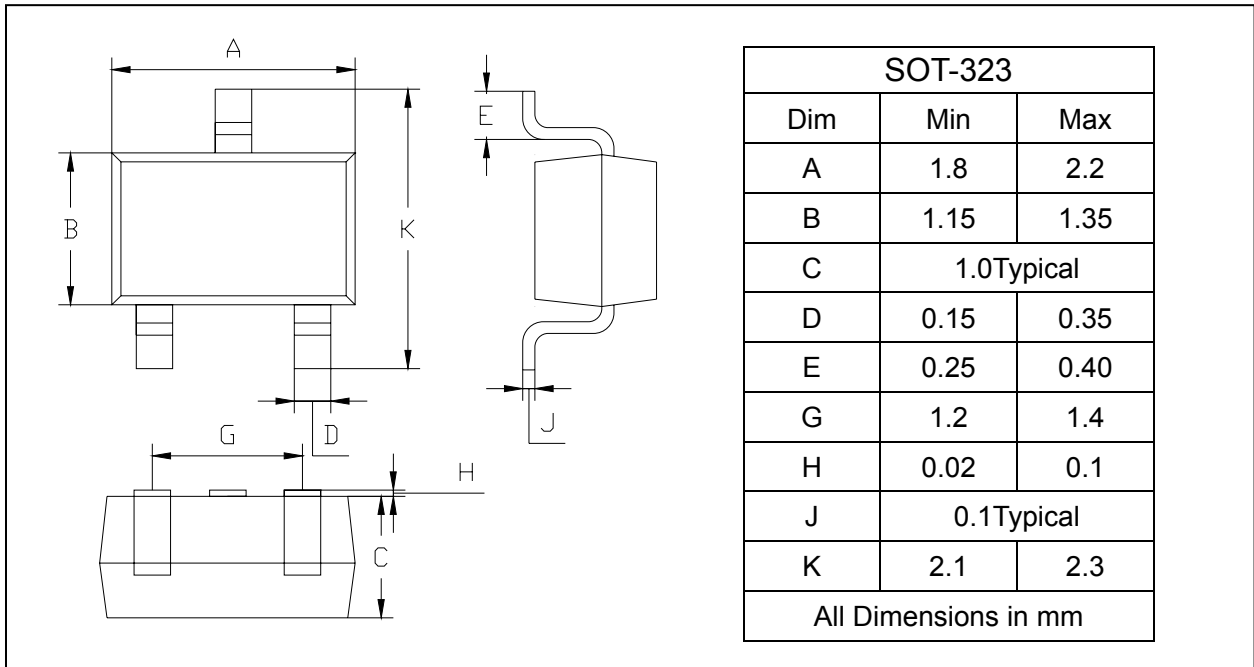

### PACKAGE INFORMATION

Device	Package	Shipping
2SC3356W	SOT-323	3000/Tape&Reel