

## Silicon NPN Epitaxial Transistor

## 2SC2873

### FEATURES

- Small flat package.
- Low saturation voltage  $V_{CE(sat)} = -0.5V$
- High speed switching time
- Complementary to 2SA1213

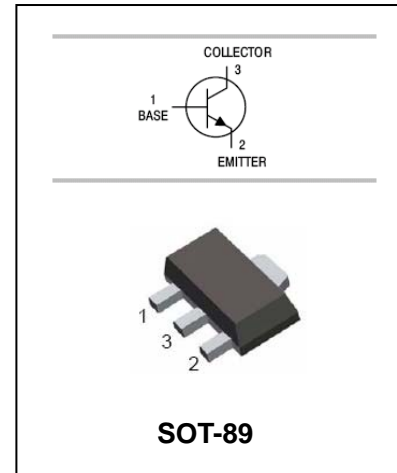

### APPLICATIONS

- Power amplifier
- Power Switching

### ORDERING INFORMATION

Type No.	Marking	Package Code
2SC2873	MO/MY	SOT-89

### MAXIMUM RATING @ Ta=25°C unless otherwise specified

Symbol	Parameter	Value	Units
$V_{CBO}$	Collector-Base Voltage	50	V
$V_{CEO}$	Collector-Emitter Voltage	50	V
$V_{EBO}$	Emitter-Base Voltage	5	V
$I_C$	Collector Current -Continuous	2	A
$I_B$	Base Current	0.4	A
$P_C$	Collector Power Dissipation	500	mW
$P_C$	Collector Power Dissipation(Note 1)	1000	mW
$T_j, T_{stg}$	Junction and Storage Temperature	-55 to +150	°C

Note 1: Mounted on a ceramic substrate(250mm<sup>2</sup>\*0.8t)



Silicon NPN Epitaxial Transistor

**2SC2873**

ELECTRICAL CHARACTERISTICS @ Ta=25°C unless otherwise specified

Parameter	Symbol	Test conditions	MIN	TYP	MAX	UNIT
Collector-emitter breakdown voltage	$V_{(BR)CEO}$	$I_C=10mA, I_B=0$	50			V
Collector cut-off current	$I_{CBO}$	$V_{CB}=50V, I_E=0$			0.1	$\mu A$
Emitter cut-off current	$I_{EBO}$	$V_{EB}=5V, I_C=0$			0.1	$\mu A$
DC current gain	$h_{FE}$	$V_{CE}=2V, I_C=500mA$	70		240	
		$V_{CE}=2V, I_C=2A$	20			
Collector-emitter saturation voltage	$V_{CE(sat)}$	$I_C=1A, I_B=50mA$			0.5	V
Base-emitter saturation voltage	$V_{BE(sat)}$	$I_C=1A, I_B=50mA$			1.2	V
Transition frequency	$f_T$	$V_{CE}=2V, I_C=0.5A$		120		MHz
Collector output capacitance	$C_{ob}$	$V_{CB}=10V, I_E=0, f=1MHz$		30		pF

CLASSIFICATION OF  $h_{FE}$

Rank	O	Y
Range	70-140	120-240
MARKING	MO	MY

TYPICAL CHARACTERISTICS @ Ta=25°C unless otherwise specified

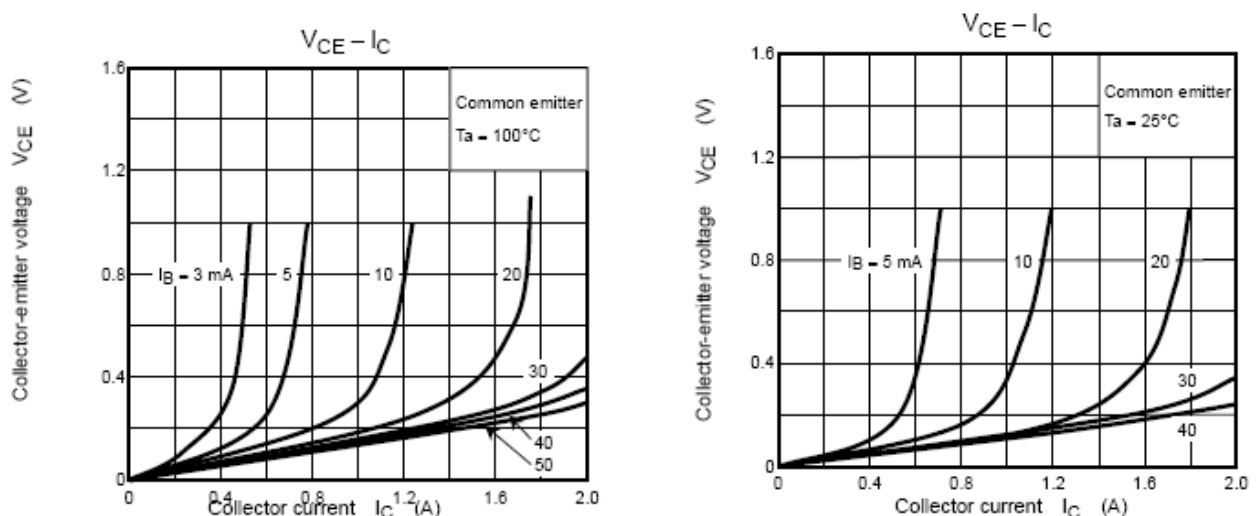



Silicon NPN Epitaxial Transistor

2SC2873

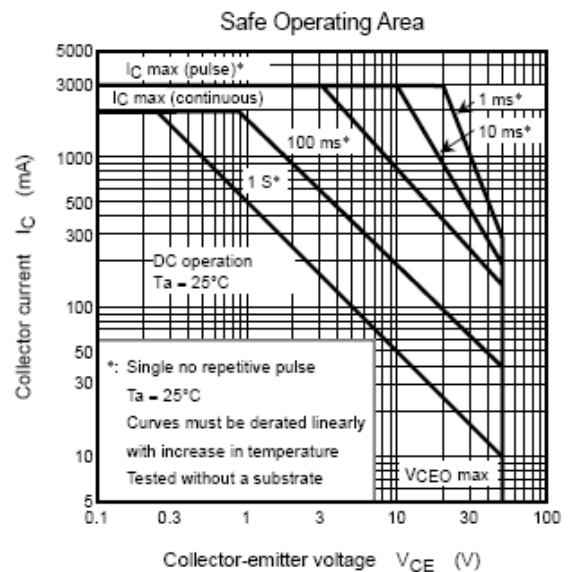
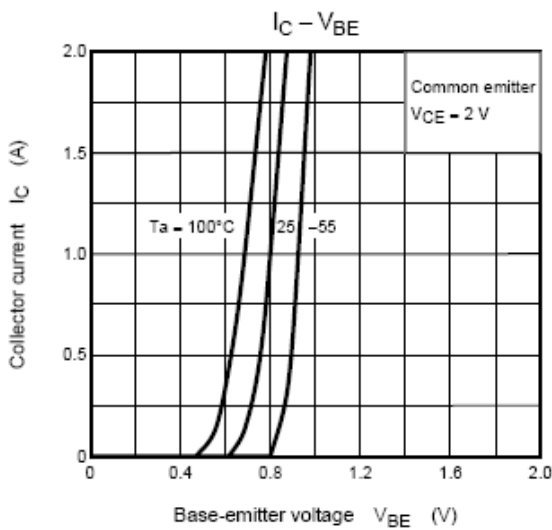
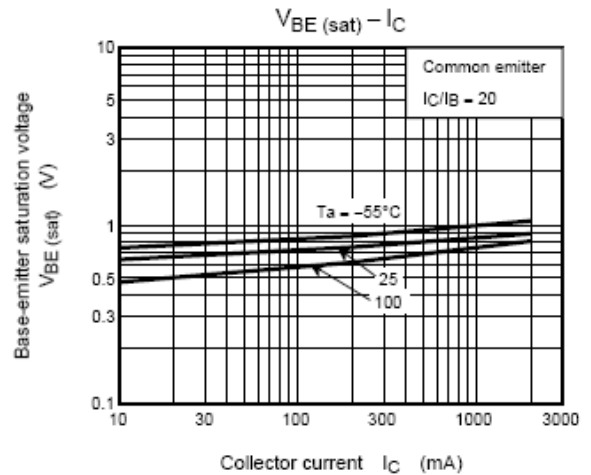
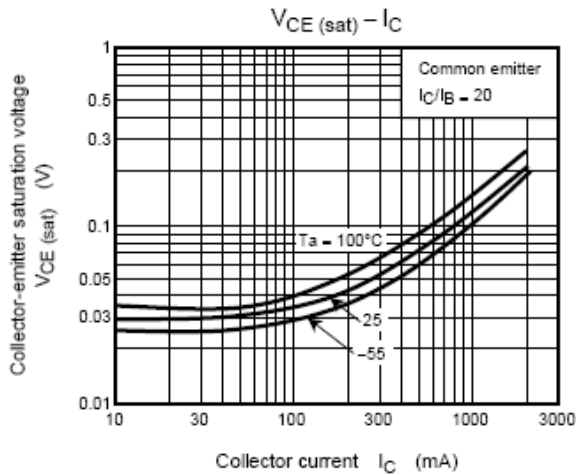
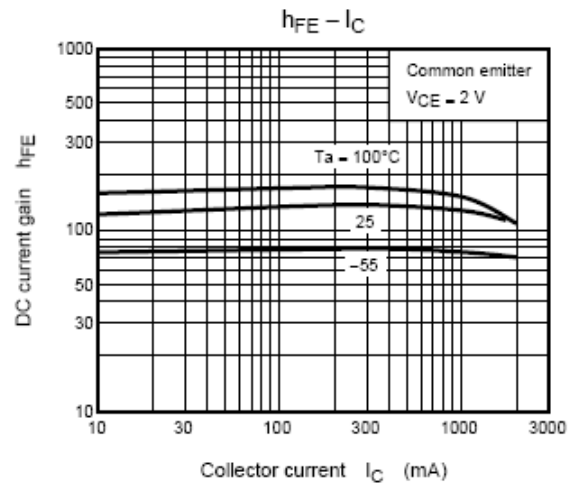
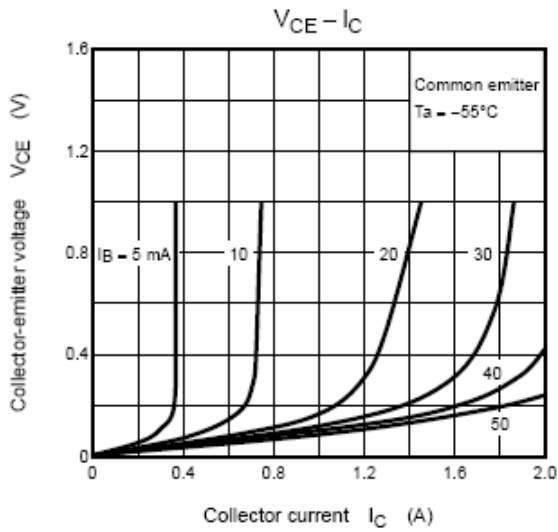



Silicon NPN Epitaxial Transistor

**2SC2873**

PACKAGE OUTLINE

Plastic surface mounted package

SOT-89

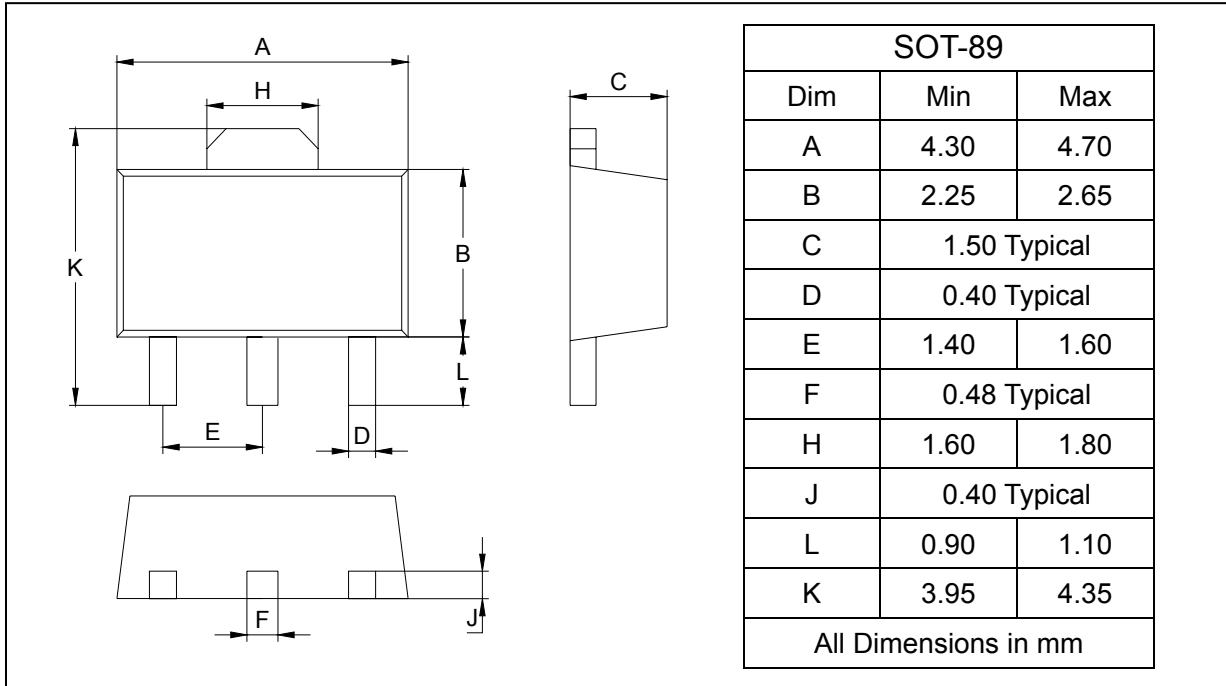

SOLDERING FOOTPRINT

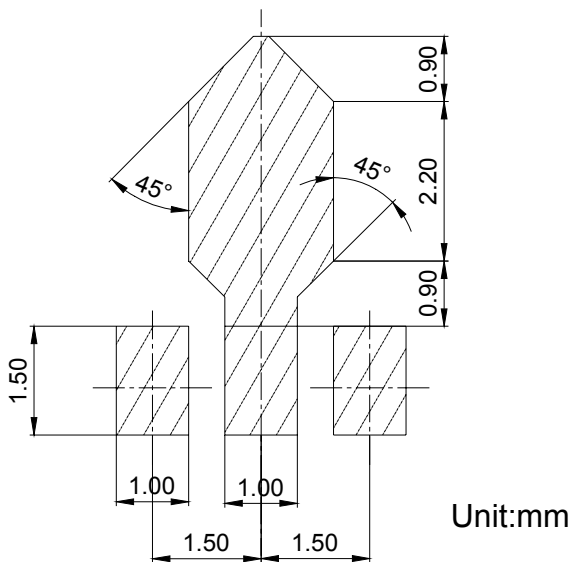

PACKAGE INFORMATION

Device	Package	Shipping
2SC2873	SOT-89	1000/Tape&Reel