

Silicon NPN Power Transistors

2SC2534

DESCRIPTION

- With TO-220C package
- High collector breakdown voltage
: $V_{CEO}=400V(\text{Min})$
- Excellent switching time
: $t_r=1.0\mu s(\text{Max.})$
: $t_f=1.0\mu s(\text{Max.})$

APPLICATIONS

- High speed high voltage switching applications
- Switching regulator applications
- High speed DC-DC converter applications

PINNING

PIN	DESCRIPTION
1	Base
2	Collector;connected to mounting base
3	Emitter

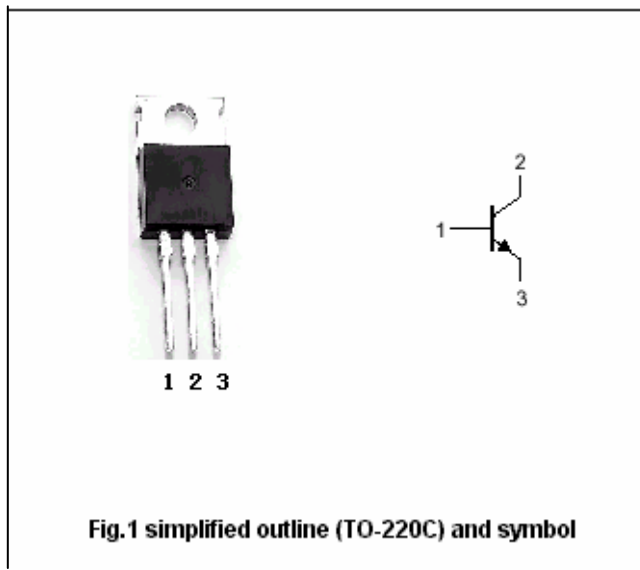

Fig.1 simplified outline (TO-220C) and symbol

Absolute maximum ratings($T_a=25^\circ C$)

SYMBOL	PARAMETER	CONDITIONS	VALUE	UNIT
V_{CBO}	Collector-base voltage	Open emitter	500	V
V_{CEO}	Collector-emitter voltage	Open base	400	V
V_{EBO}	Emitter-base voltage	Open collector	6	V
I_C	Collector current		2	A
I_B	Base current		0.5	A
P_C	Collector dissipation	$T_a=25^\circ C$	1.5	W
		$T_C=25^\circ C$	20	
T_j	Junction temperature		150	$^\circ C$
T_{stg}	Storage temperature		-55~150	$^\circ C$

Silicon NPN Power Transistors

2SC2534

CHARACTERISTICS

T_j=25°C unless otherwise specified

SYMBOL	PARAMETER	CONDITIONS	MIN	TYP.	MAX	UNIT
V _{(BR)CEO}	Collector-emitter breakdown voltage	I _C =10mA ; I _B =0	400			V
V _{(BR)CBO}	Collector-base breakdown voltage	I _C =1mA ; I _E =0	500			V
V _{(BR)EBO}	Emitter-base breakdown voltage	I _E =1mA ; I _C =0	6			V
V _{CEsat}	Collector-emitter saturation voltage	I _C =0.5A ; I _B =50mA			1.0	V
V _{BEsat}	Base-emitter saturation voltage	I _C =0.5A ; I _B =50mA			1.5	V
I _{CBO}	Collector cut-off current	V _{CB} =400V ; I _E =0			100	μA
I _{EBO}	Emitter cut-off current	V _{EB} =6V ; I _C =0			1	mA
h _{FE-1}	DC current gain	I _C =0.1A ; V _{CE} =5V	20			
h _{FE-2}	DC current gain	I _C =0.5A ; V _{CE} =5V	20			

Switching times

t _r	Rise time	V _{CC} =200V; I _{B1} =-I _{B2} =50mA; R _L =400Ω Duty cycle≤1%			1.0	μs
t _{stg}	Storage time				2.5	μs
t _f	Fall time				1.0	μs

Silicon NPN Power Transistors

2SC2534

PACKAGE OUTLINE

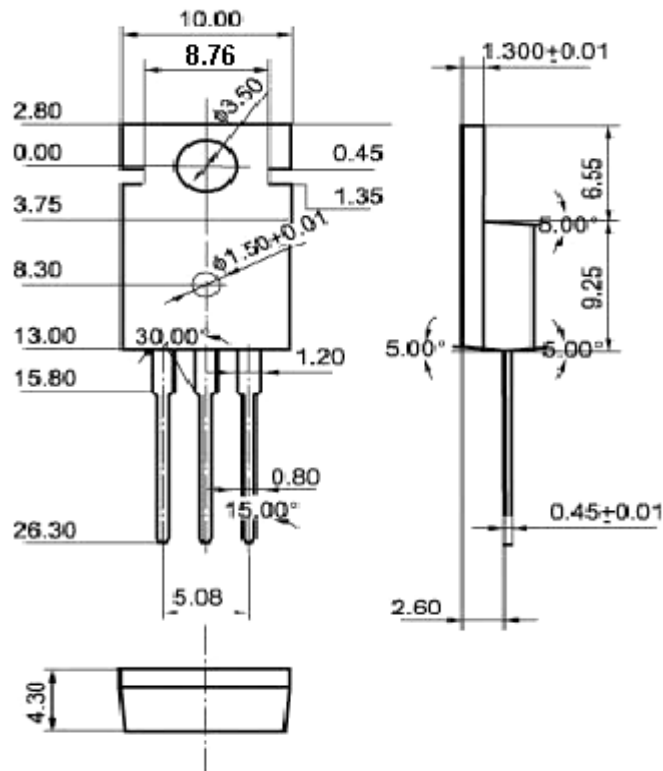

Fig.2 Outline dimensions (unindicated tolerance: ± 0.10 mm)

Silicon NPN Power Transistors

2SC2534

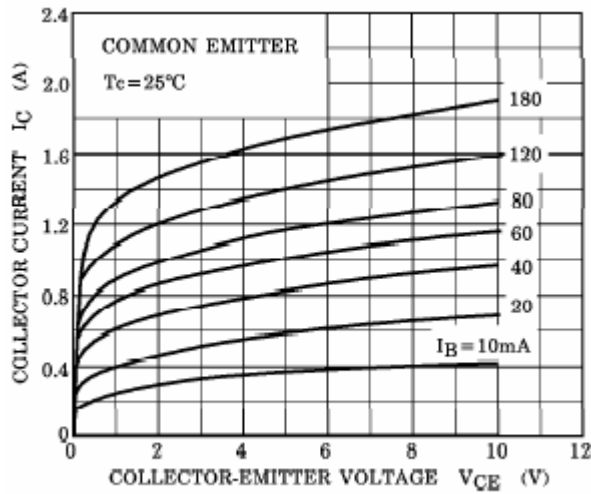

Fig.3 Static Characteristic

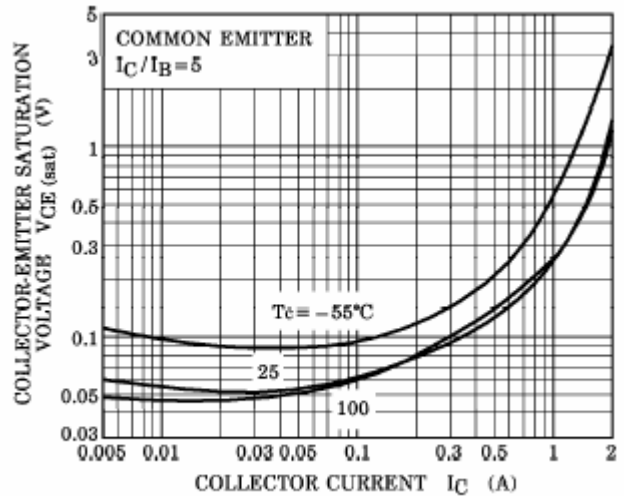

Fig.4 Collector-Emitter Saturation Voltage

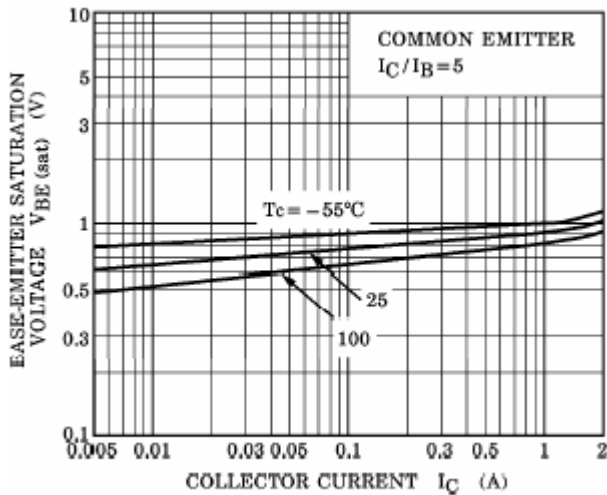

Fig.5 Base-Emitter Saturation Voltage

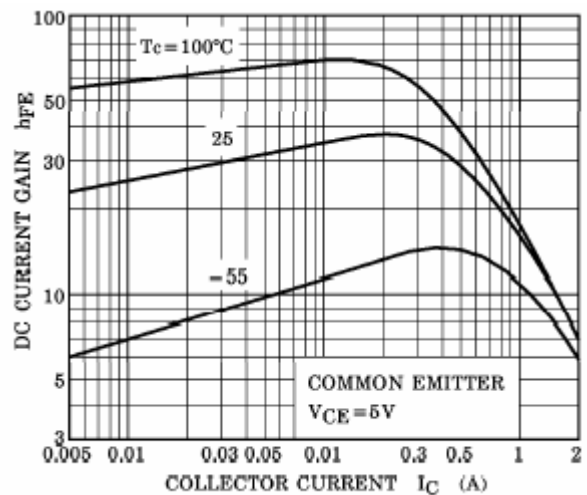

Fig.6 DC current Gain

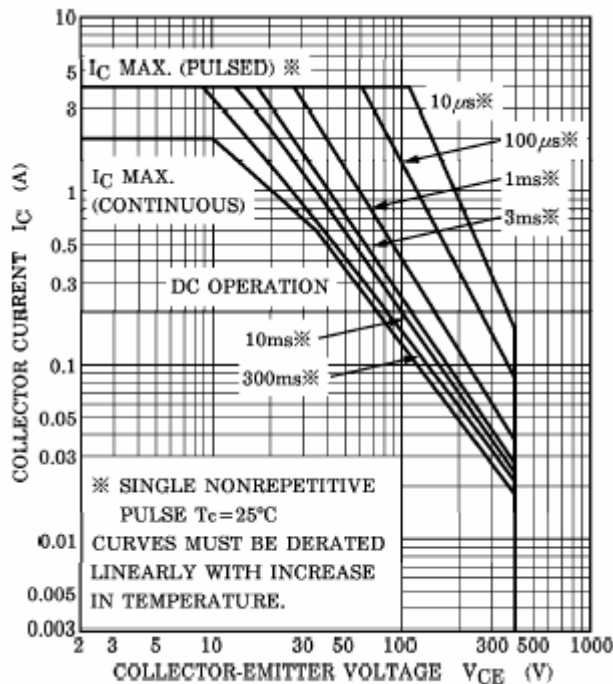

Fig.7 Safe Operating Area