

# MITSUBISHI RF POWER TRANSISTOR 2SC2097

## NPN EPITAXIAL PLANAR TYPE

### DESCRIPTION

2SC2097 is a silicon NPN epitaxial planar type transistor designed for RF power amplifiers in HF band mobile radio applications.

### FEATURES

- High power gain:  $G_{pe} \geq 12.3\text{dB}$   
@  $V_{CC} = 13.5\text{V}$ ,  $P_O = 75\text{W}$ ,  $f = 30\text{MHz}$
- Emitter ballasted construction for good performances.
- Low thermal resistance ceramic package with flange.
- Ability of withstanding infinite load VSWR when operated at  $V_{CC} = 15.2\text{V}$ ,  $P_O = 70\text{W}$ ,  $f = 30\text{MHz}$ ,  $T_C = 25^\circ\text{C}$ .

### APPLICATION

HF band linear power amplifiers in push-pull class AB operation.

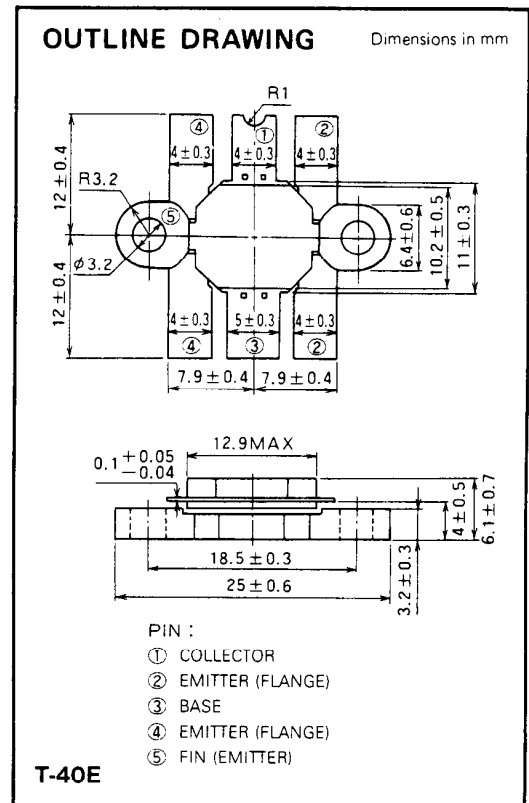

### ABSOLUTE MAXIMUM RATINGS ( $T_C = 25^\circ\text{C}$ unless otherwise specified)

Symbol	Parameter	Conditions	Ratings	Unit
$V_{CB0}$	Collector to base voltage		50	V
$V_{EB0}$	Emitter to base voltage		5	V
$V_{CE0}$	Collector to emitter voltage	$R_{BE} = \infty$	20	V
$I_C$	Collector current		15	A
$P_C$	Collector dissipation	$T_a = 25^\circ\text{C}$	7.5	W
		$T_C = 25^\circ\text{C}$	150	W
$T_j$	Junction temperature		175	$^\circ\text{C}$
$T_{stg}$	Storage temperature		-55 to 175	$^\circ\text{C}$
$R_{th-a}$	Thermal resistance	Junction to ambient	20	$^\circ\text{C/W}$
		Junction to case	1.2	$^\circ\text{C/W}$

Note. Above parameters are guaranteed independently.

### ELECTRICAL CHARACTERISTICS ( $T_C = 25^\circ\text{C}$ unless otherwise specified)

Symbol	Parameter	Test conditions	Limits			Unit
			Min	Typ	Max	
$V_{(BR)EBO}$	Emitter to base breakdown voltage	$I_E = 10\text{mA}$ , $I_C = 0$	5			V
$V_{(BR)CB0}$	Collector to base breakdown voltage	$I_C = 20\text{mA}$ , $I_E = 0$	50			V
$V_{(BR)CE0}$	Collector to emitter breakdown voltage	$I_C = 0.1\text{A}$ , $R_{BE} = \infty$	20			V
$I_{CB0}$	Collector cutoff current	$V_{CB} = 25\text{V}$ , $I_E = 0$			5	mA
$I_{EB0}$	Emitter cutoff current	$V_{EB} = 2\text{V}$ , $I_C = 0$			4	mA
$h_{FE}$	DC forward current gain*	$V_{CE} = 10\text{V}$ , $I_C = 0.1\text{A}$	10	50	180	—
$P_O$	Output power	$V_{CC} = 13.5\text{V}$ , $P_{in} = 4\text{W}$ , $f = 30\text{MHz}$	75	85		W
$\eta_C$	Collector efficiency		55	65		%

Note. \*Pulse test,  $P_W = 150\mu\text{s}$ , duty=5%.

Above parameters, ratings, limits and conditions are subject to change.

**TEST CIRCUIT**

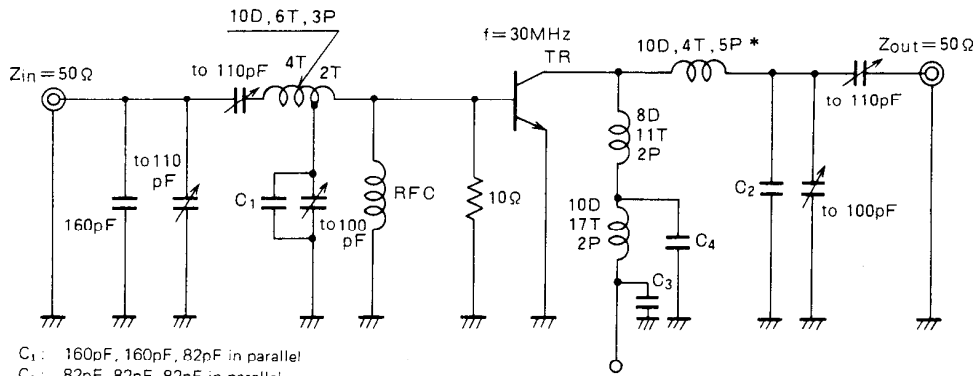

- C<sub>1</sub>: 160pF, 160pF, 82pF in parallel  
 C<sub>2</sub>: 82pF, 82pF, 82pF in parallel  
 C<sub>3</sub>: 100pF, 4700pF, 4700pF, 0.22μF, 0.22μF, 33μF, 330μF in parallel  
 C<sub>4</sub>: 100pF, 220pF, 4700pF, 0.1μF, 330μF in parallel  
 RFC: 1mmφ enameled wire 27T.  
 Notes: All coils are made from 1.5mmφ silver plated copper wire but coil (sign \*) is made from 2.3mmφ  
 D: Inner diameter of coil      P: Pitch of coil  
 T: Turn number of coil      Dimension in milli-meter

**TYPICAL PERFORMANCE DATA**

**COLLECTOR DISSIPATION VS. AMBIENT TEMPERATURE**

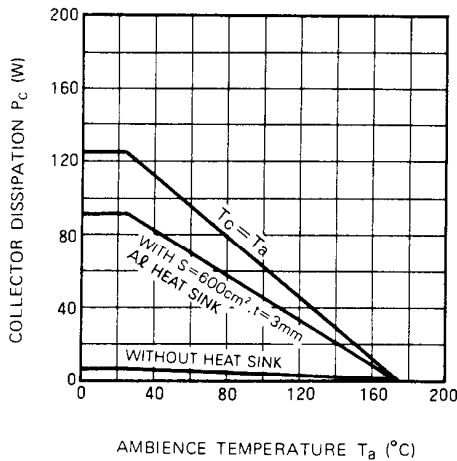

**COLLECTOR CURRENT VS. COLLECTOR TO EMITTER VOLTAGE**

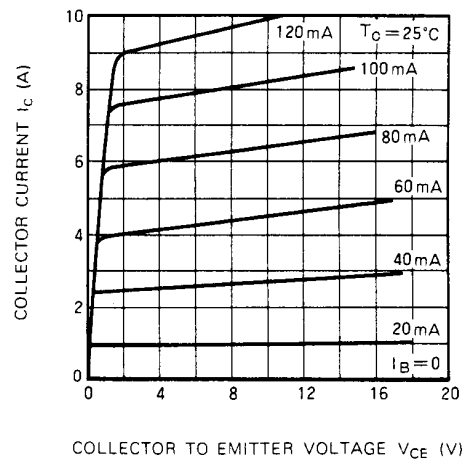

**COLLECTOR TO EMITTER BREAKDOWN VOLTAGE VS. BASE TO EMITTER RESISTANCE**

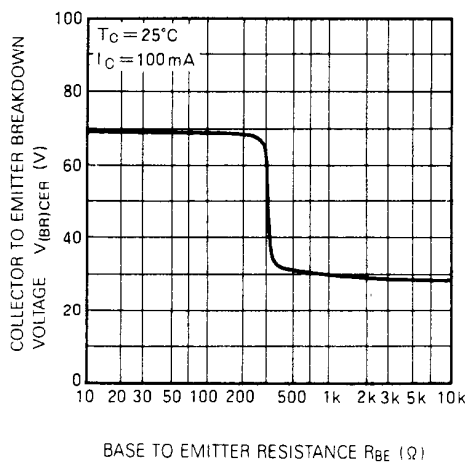

**DC CURRENT GAIN VS. COLLECTOR CURRENT**

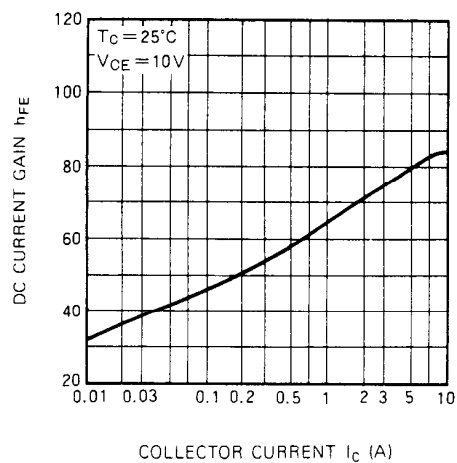

**NPN EPITAXIAL PLANAR TYPE**

**COLLECTOR OUTPUT CAPACITANCE VS. COLLECTOR TO BASE VOLTAGE**

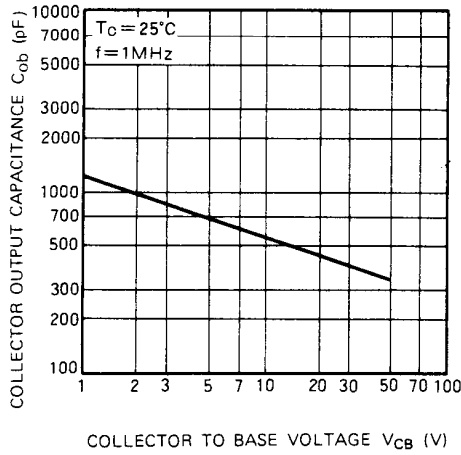

**OUTPUT POWER, COLLECTOR EFFICIENCY VS. INPUT POWER**

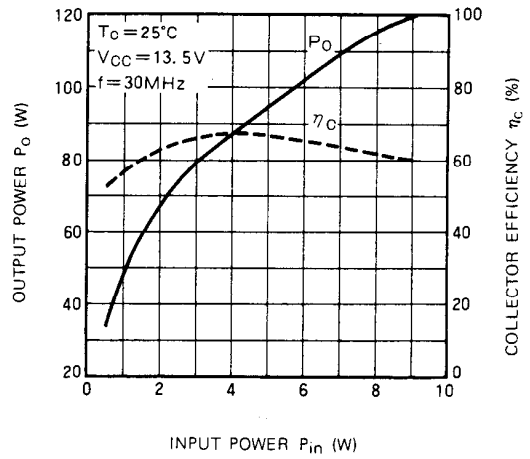

**OUTPUT POWER VS. COLLECTOR SUPPLY VOLTAGE**

