



2SB798

PN EPITAXIAL SILICON TRANSISTOR

POWER TRANSISTOR

DESCRIPTION

The UTC **2SB798** is designed for audio frequency power amplifier applications, especially in Hybrid Integrated Circuits.

FEATURES

- * Low Collector Saturation Voltage:
 $V_{CE(sat)} < -0.4V$ ($I_C = -1.0A, I_B = -100mA$)
- * Excellent DC Current Gain Linearity :
 $h_{FE} = 100$ Typ. ($V_{CE} = -1.0V, I_C = -1.0A$)

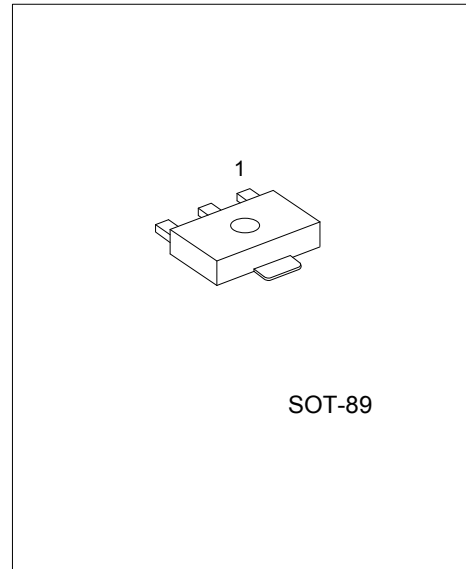

ORDERING INFORMATION

Ordering Number		Package	Pin Assignment			Packing
Lead Free	Halogen Free		1	2	3	
2SB798L-X-AB3-R	2SB798G-X-AB3-R	SOT-89	B	C	E	Tape Reel

<p>2SB798L-X-AB3-R</p>	<p>(1) R: Tape Reel (2) AB3: SOT-89 (3) x: refer to Classification of h_{FE1} (4) Halogen Free, L: Lead Free</p>
------------------------	---

■ ABSOLUTE MAXIMUM RATINGS (T_A=25°C)

PARAMETER		SYMBOL	RATINGS	UNIT
Collector-Base Voltage		V _{CBO}	-30	V
Collector-Emitter Voltage		V _{CEO}	-25	V
Emitter-Base Voltage		V _{EBO}	-5.0	V
Collector Current	DC	I _C	-1.0	A
	Pulse(Note 1)		-1.5	A
Collector Dissipation (Note 2)		P _C	2	W
Junction Temperature		T _J	150	°C
Storage Temperature		T _{STG}	-55 ~ +150	°C

Notes: Absolute maximum ratings are those values beyond which the device could be permanently damaged.

Absolute maximum ratings are stress ratings only and functional device operation is not implied.

1. PW ≤ 10ms, Duty Cycle ≤ 50%
2. When mounted on a ceramic substrate of 16cm²×0.7 mm.

■ ELECTRICAL CHARACTERISTICS (T_A=25°C, unless otherwise specified)

PARAMETER	SYMBOL	TEST CONDITIONS	MIN	TYP	MAX	UNIT
Collector Cut-Off Current	I _{CBO}	V _{CB} = -30V, I _E = 0			-100	nA
Emitter Cut-Off Current	I _{EBO}	V _{EB} = -5.0V, I _C = 0			-100	nA
DC Current Gain	h _{FE1}	V _{CE} = -1.0V, I _C = -100mA	90	200	400	
DC Current Gain	h _{FE2}	V _{CE} = -1.0V, I _C = -1.0A	50	100		
Base to Emitter Voltage	V _{BE}	V _{CE} = -6.0V, I _C = -10mA	-600	-640	-700	mV
Collector-Emitter Saturation Voltage	V _{CE(sat)}	I _C = -1.0A, I _B = -0.10A		-0.25	-0.40	V
Base-Emitter Saturation Voltage	V _{BE(sat)}	I _C = -1.0A, I _B = -0.10A		-1.0	-1.2	V
Gain Bandwidth Product	f _T	V _{CE} = -6.0V, I _E = 10mA		110		MHz
Output Capacitance	C _{ob}	V _{CB} = -6.0V, I _E = 0, f=1MHz		36		pF

Note: 3. PW ≤ 350μs, Duty Cycle ≤ 2%

■ CLASSIFICATION OF h_{FE1}

MARKING	DM	DL	DK
h _{FE1}	90-180	135-270	200-400

TYPICAL CHARACTERISTICS

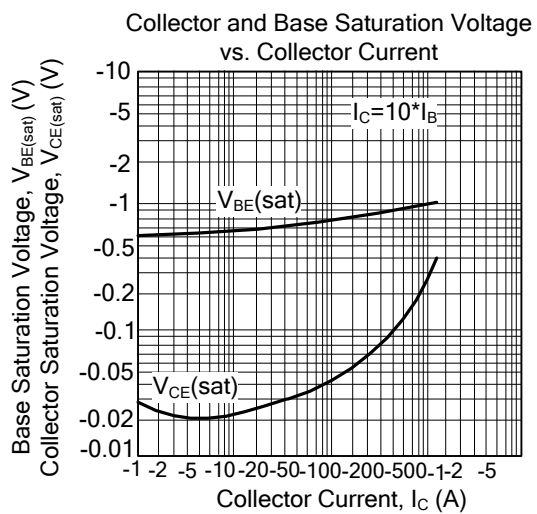
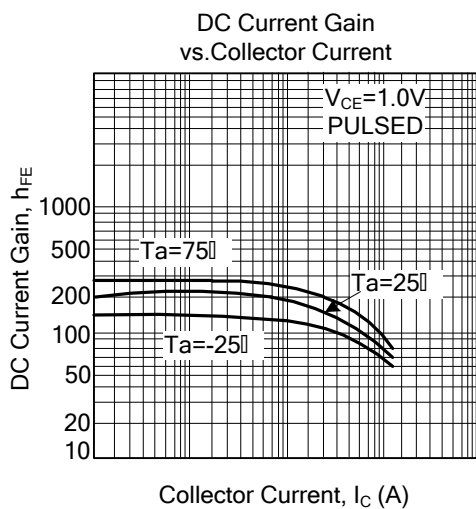
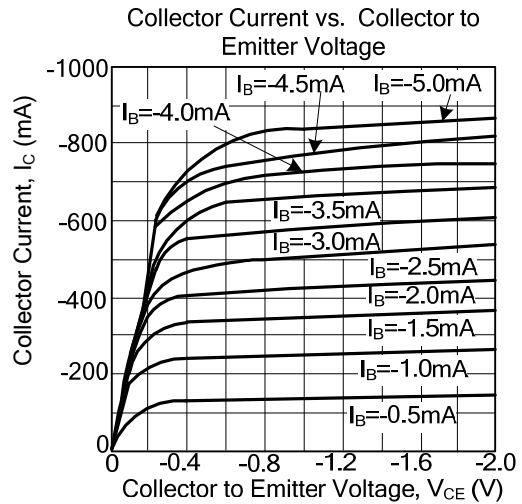
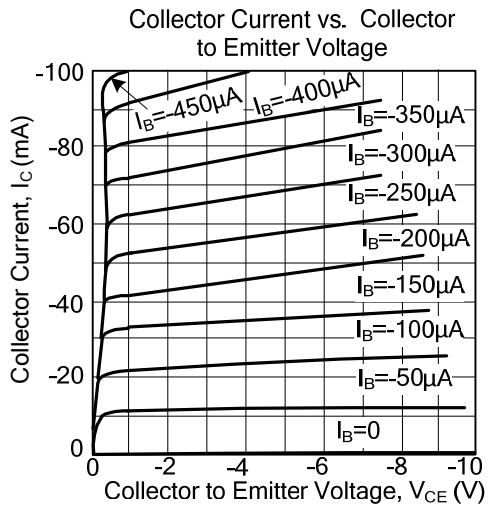
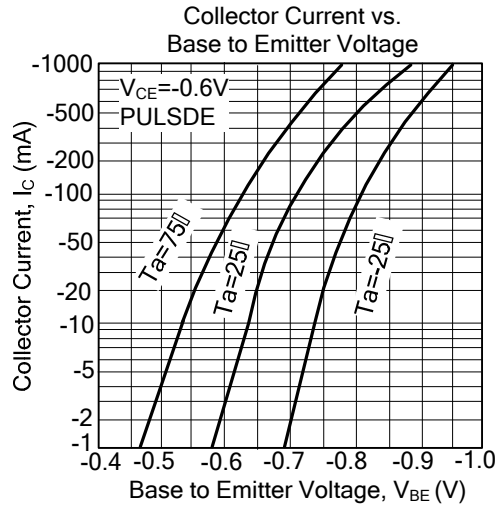
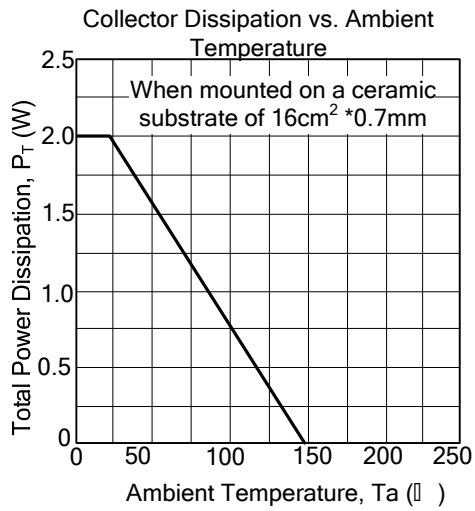

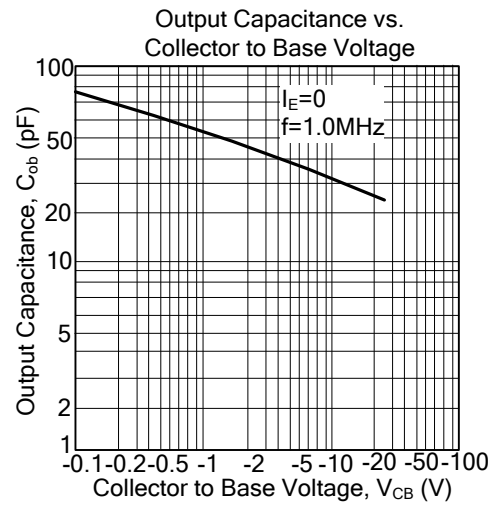
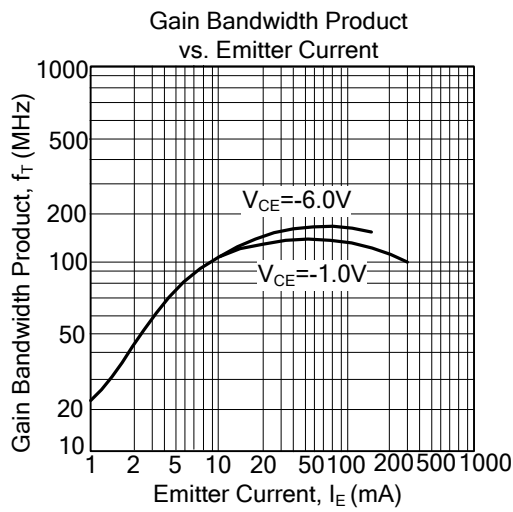

UTC assumes no responsibility for equipment failures that result from using products at values that exceed, even momentarily, rated values (such as maximum ratings, operating condition ranges, or other parameters) listed in products specifications of any and all UTC products described or contained herein. UTC products are not designed for use in life support appliances, devices or systems where malfunction of these products can be reasonably expected to result in personal injury. Reproduction in whole or in part is prohibited without the prior written consent of the copyright owner. The information presented in this document does not form part of any quotation or contract, is believed to be accurate and reliable and may be changed without notice.