

**2SD313,
314**



NPN/PNP Triple Diffused Planar Silicon Transistors

T-33-09

**2SB507,
508**

Low Frequency Power Amp Applications

©396E

.2SB507,2SB508 and 2SD313,2SD314 are complementary pairs respectively.
 .These are designed for the output stage of 15W to 25W AF power amplifier.
 .2SB507 and 2SB508, or 2SD313 and 2SD314, differ from their care outlines only.

() shows the case of 2SB507, 2SB508 only.

Absolute Maximum Ratings at Ta=25°C

Collector to Base Voltage	V _{CB0}	(-) 60	V
Collector to Emitter Voltage	V _{CE0}	(-) 60	V
Emitter to Base Voltage	V _{EB0}	(-) 5	V
Collector Current	I _C	(-) 3	A
	i _{cp}	(-) 8	A
Collector Dissipation	P _C	1.75	W
		30	W
		T _C =25°C	
Junction Temperature	T _j	150	°C
Storage Temperature	T _{stg}	-55 to +150	°C

Electrical Characteristics at Ta=25°C

			min	typ	max	unit
Collector Cut Off Current	I _{CB0}	V _{CB} =(-) 20V, I _E =0			(-) 0.1	mA
	I _{CE0}	V _{CE} =(-) 60V, R _{BE} =∞			(-) 5	mA
Emitter Cut Off Current	I _{EB0}	V _{EB} =(-) 4V, I _C =0			(-) 1	mA
Secondary Breakdown Voltage	V _{S/B}	I _C =(-) 0.5A, t=1sec	(-) 60			V
DC Current Gain	h _{FE} (1)	V _{CE} =(-) 2V, I _C =(-) 1A	40*		320*	
	h _{FE} (2)	V _{CE} =(-) 2V, I _C =(-) 0.1A	40			
Gain Band Width Product	f _T	V _{CE} =(-) 5V, I _C =(-) 0.5A		8		MHz
Output Capacitance	c _{ob}	(V _{CB} =(-) 10V, f=1MHz)		(130)		pF
				65		pF
C-E Saturation Voltage	V _{CE(sat)}	I _C =(-) 2A, I _B =(-) 0.2A	(-) 0.4		(-) 1.0	V
Base to Emitter Voltage	V _{BE}	I _C =(-) 1A, V _{CE} =(-) 2V			(-) 1.5	V

*:2SB507,508/2SD313,314 are classified by 1A h_{FE} as follows:

40	C	80	60	D	120	100	E	200	160	F	320
----	---	----	----	---	-----	-----	---	-----	-----	---	-----

Case Outline 2010A
(unit:mm)

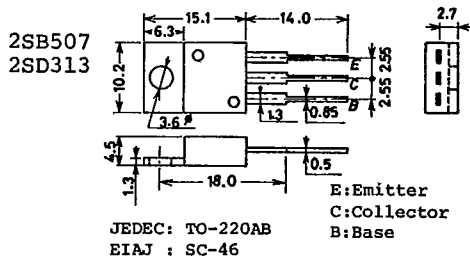

Case Outline 2012
(unit:mm)

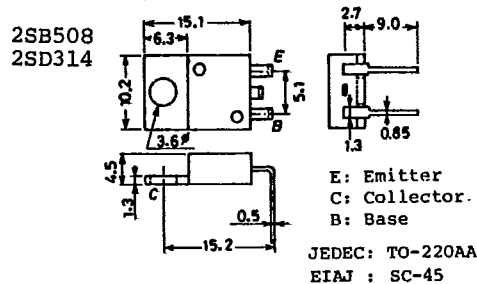

The 2SB508/D314 are scheduled to be discontinued soon. Use the 2SB507/D313, instead of the 2SB508/D314, in new applications where you are planning to use the 2SB508/D314.

2SD313,314/2SB507,508

T-33-09

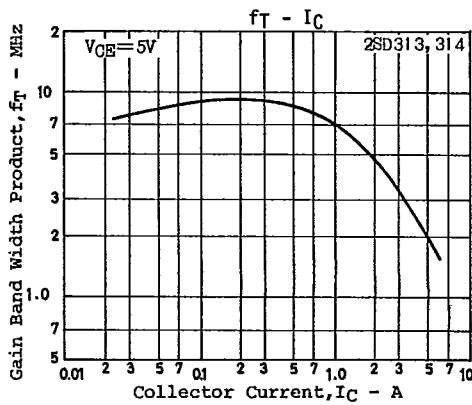
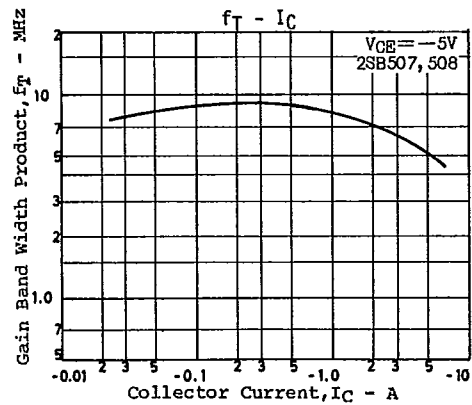
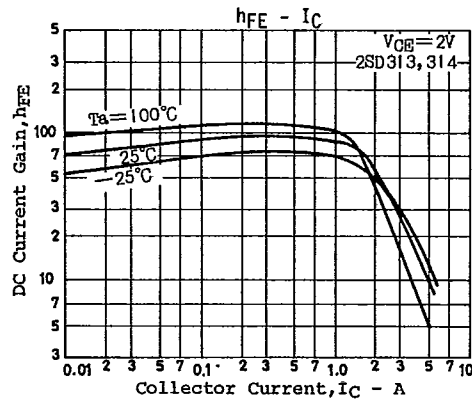
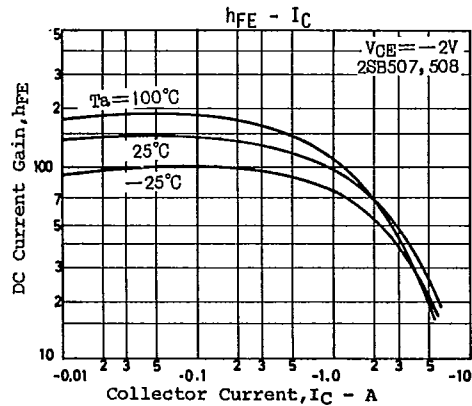
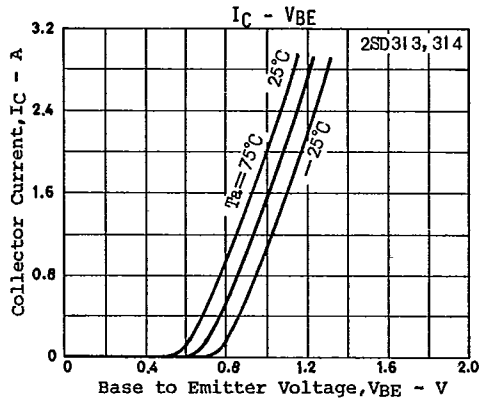
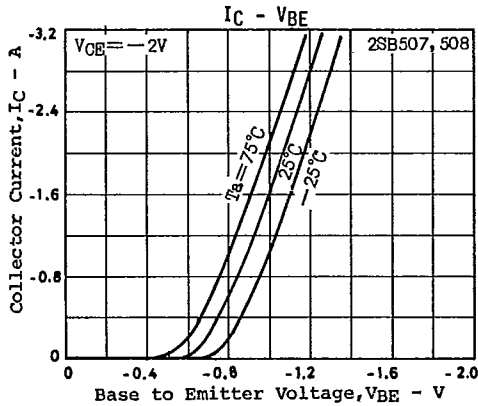
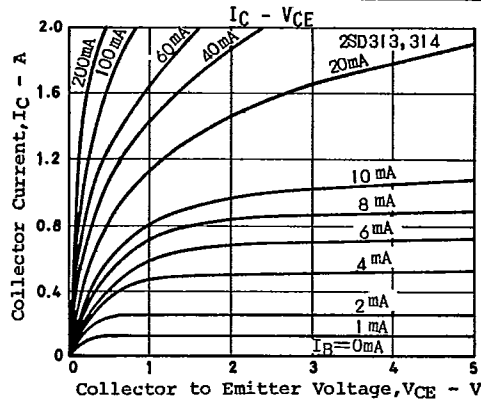
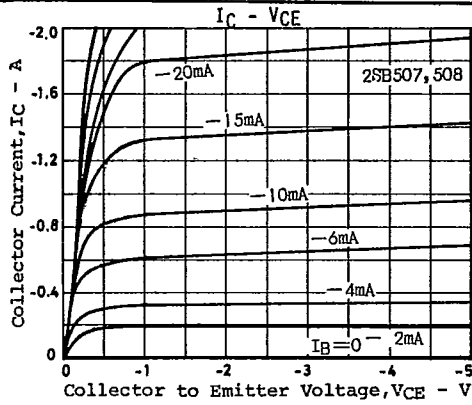

2SD313, 314/2SB507, 508

T-33-09

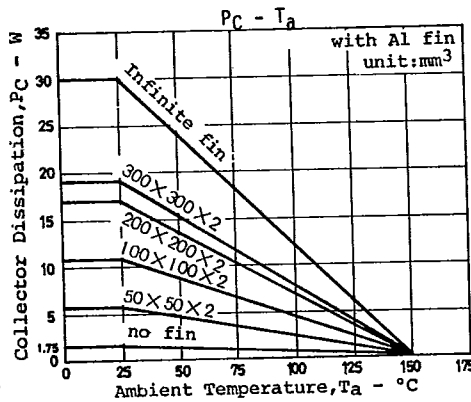
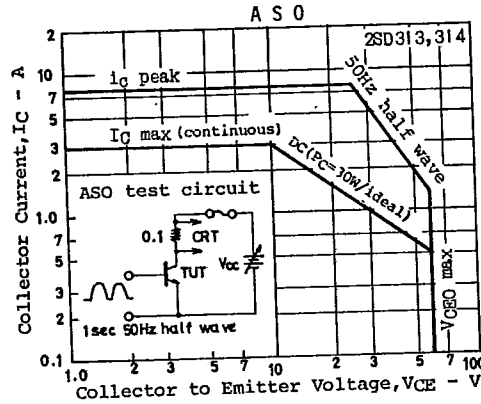
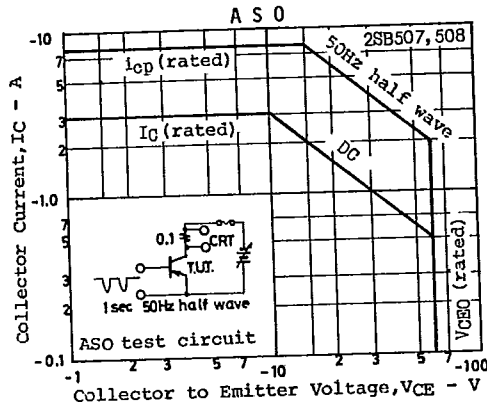
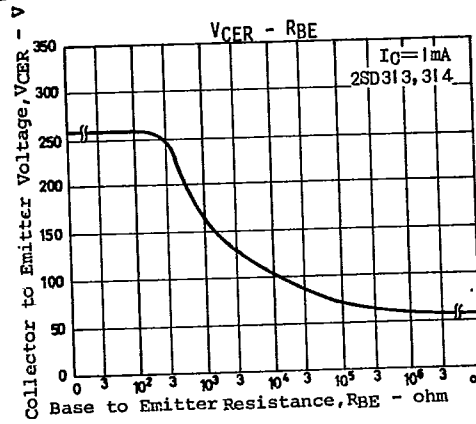
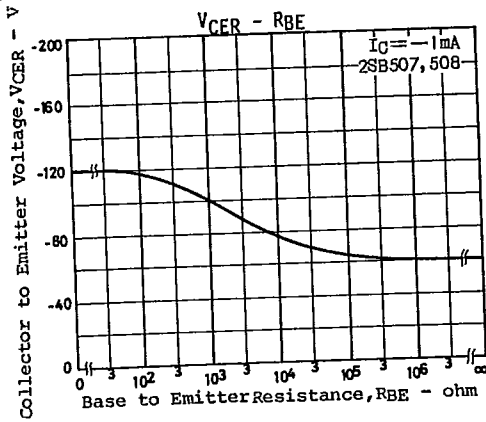

Application 1 20W Pure Complementary PP AF Power Amplifier Using 2SB507 /2SD313

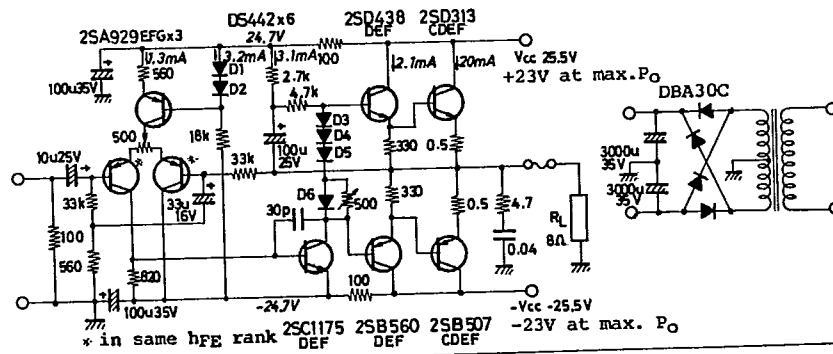

2SD313,314/2SB507,508

T-33-09

Recommended Operation Condition at Ta=25°C

Supply Voltage	VCC	±25.5	V
Load Resistance	RL	8	ohm

Operation Characteristics at Ta=25°C, RL=8ohm, f=1kHz, VCC=±25.5V(at no signal), ±23V(at max PO).

Quiescent Current	ICCO	29.7	mA
Output Power	POmax	THD=0.5%	20 W
Voltage Gain	VG	PO=1W	36 dB
Total Harmonic Distortion	THD	PO=1W	0.08 %
Input Impedance	ri	vi=10mV	100 kohm
Output Impedance	ro	PO=10W	0.16 ohm
Power Band Width	PBW	THD=0.5%, ±3dB	20 to 20k Hz
Output Noise Voltage	VNO	2.2kohm terminated	0.3 mV
Output Center Voltage	VN		0±30 mV

(Under the condition of AC 100V, transformer driven.)

Circuit Configuration

Differential amplifier for first stage. Voltage regulator for rejecting of click noise at switching-on time. Darlington output stage of 2SB507/2SD313. High input impedance of 100 kohm by bootstrap circuit. This input impedance can be varied by varying this input resistor. In order to suppress oscillation, 30pF between base and collector, and 4.7ohm/0.04uF in parallel with RL of output are available. Nevertheless frequency response is -2dB at 100kHz. In emitter of differential amplifier of first stage 500 ohm variable resistor makes output center voltage to zero whatever hFE rank used.

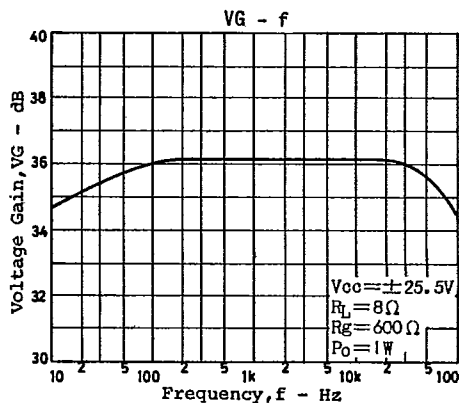
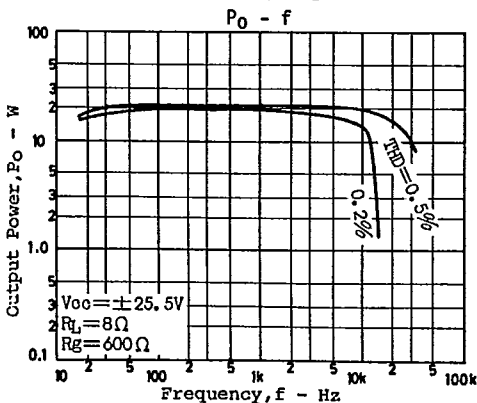
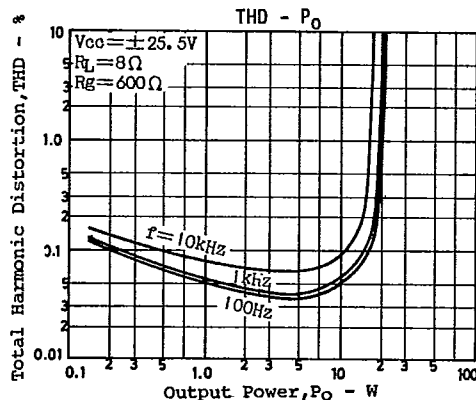
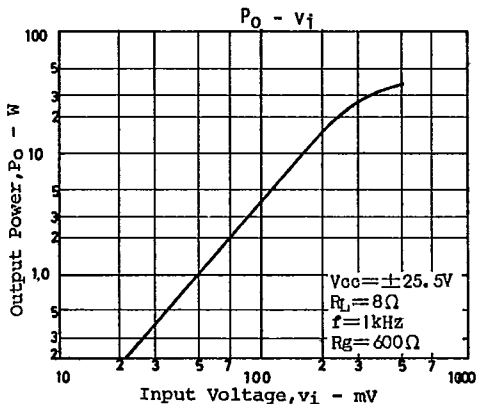

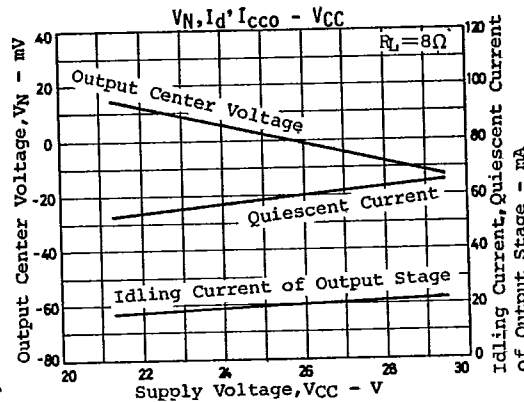
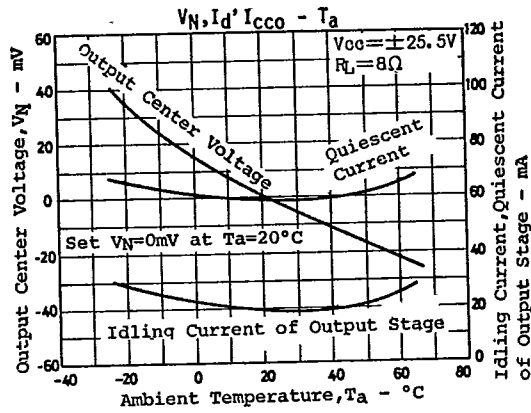
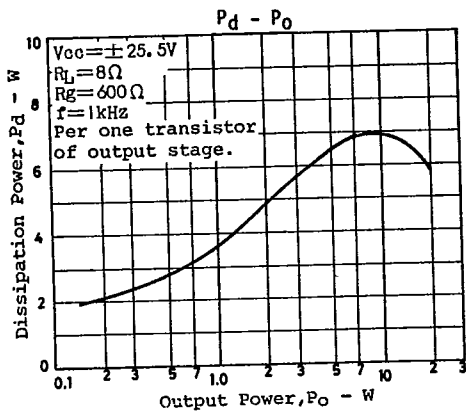

Application 2 20W AF Power Amplifier Using 2SD313(2SD314)x2.

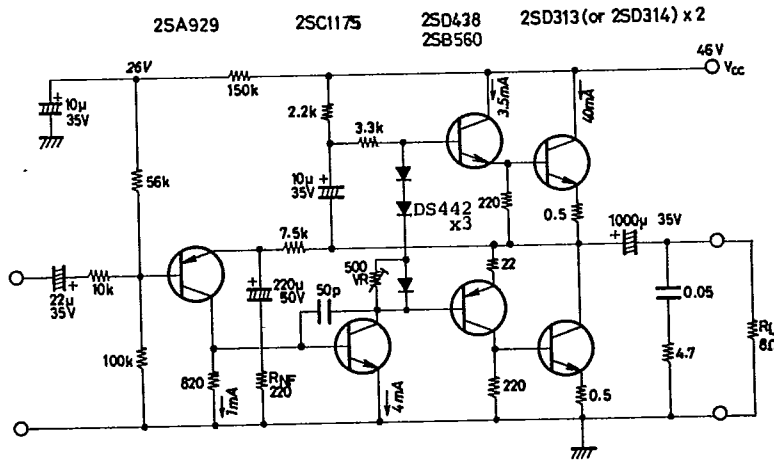

Main Characteristics

Operating Temperature	Topg	Operates at Po=8W, Ta=25 to 60 °C	
Load Shorting Test	ts	Perfect at VCC 10% up, 10 seconds shorted.	
Supply Voltage	VCC	50	V
Load Resistance	RL	8	ohm
Maximum Output Power	Po	20	W
Voltage Gain	VG	30.8	dB
Total Harmonic Distortion	THD	0.1	%
Input Impedance	ri	45k	ohm
Output Impedance	ro	0.2	ohm
Quiescent Current	Icco	40	mA

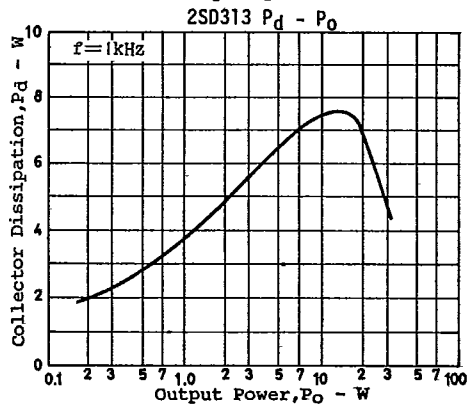
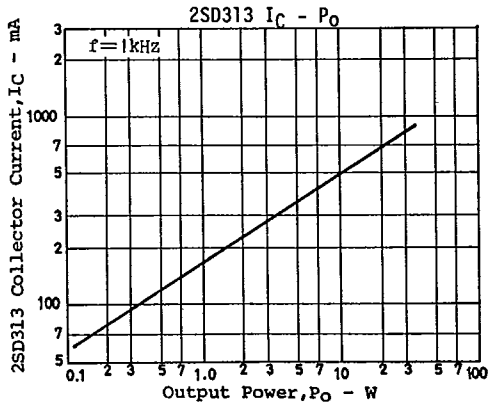
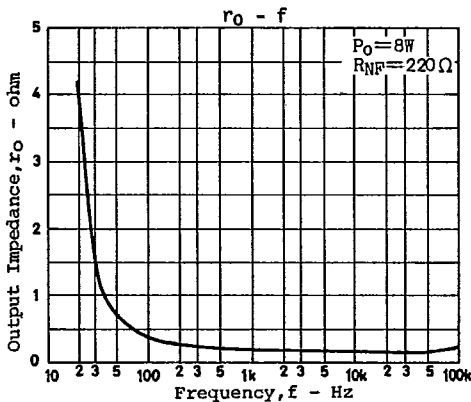
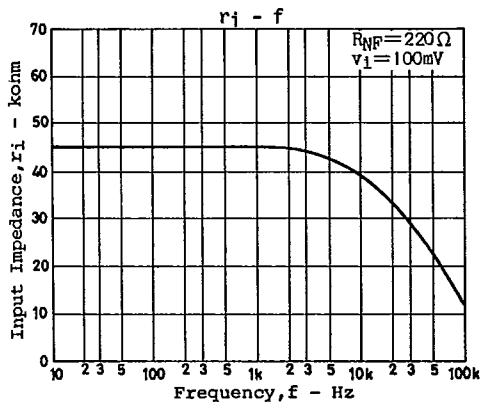
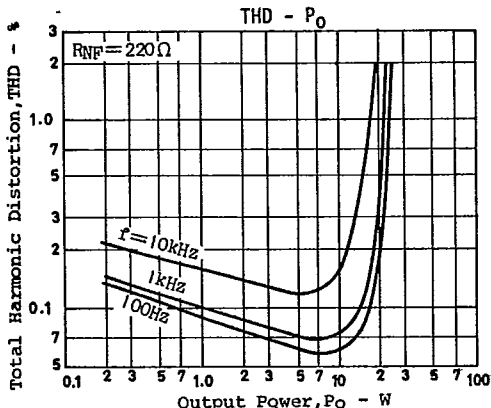
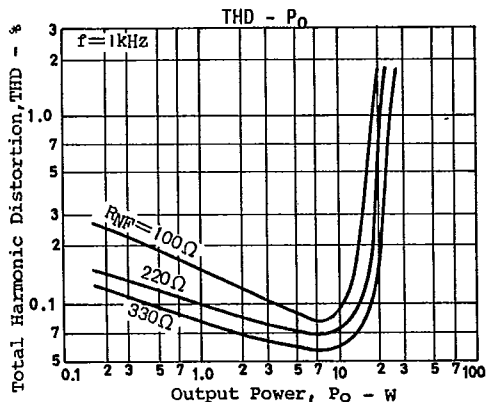
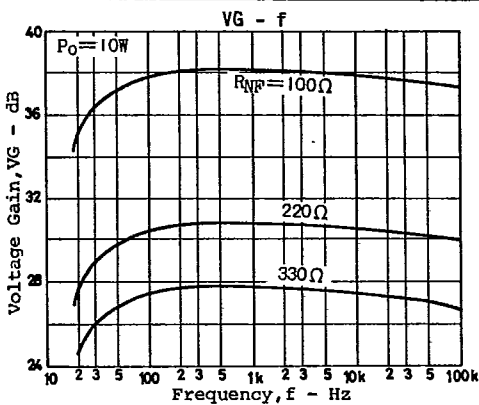
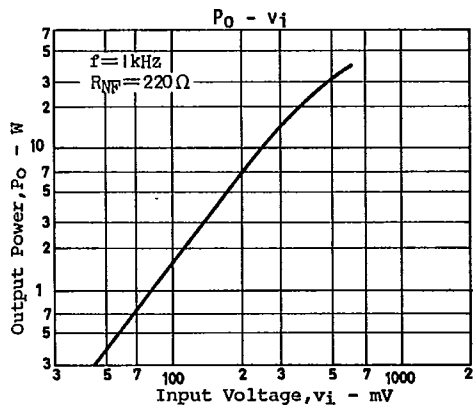

T-91-20

CASE OUTLINES AND ATTACHMENTS

- All of Sanyo Transistor case outlines are illustrated below.
- All dimensions are in mm, and dimensions which are not followed by min. or max. are represented by typical values.
- No marking is indicated.

Case Outline-[2003A]

unit:mm

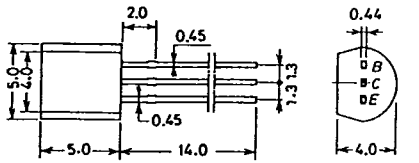

JEDEC: TO-92
EIAJ: SC-43
SANYO: NP

B: Base
C: Collector
E: Emitter

Case Outline-[2009A]

unit:mm

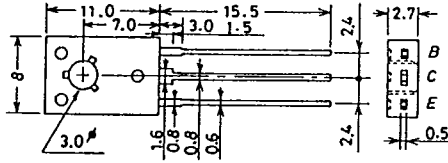

JEDEC: TO-126

B: Base
C: Collector
E: Emitter

Case Outline-[2004A]

unit:mm

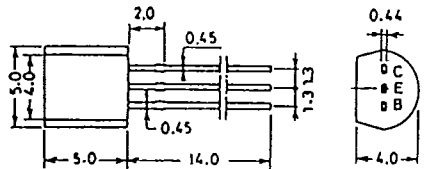

JEDEC: TO-92
EIAJ: SC-43
SANYO: NP

C: Collector
E: Emitter
B: Base

Case Outline-[2010A]

unit:mm

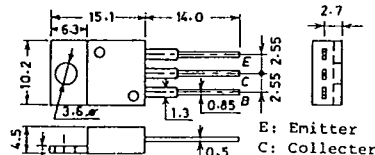

JEDEC: TO-220AB
EIAJ: SC-46

E: Emitter
C: Collector
B: Base

Case Outline-[2005A]

unit:mm

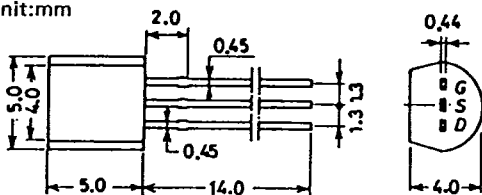

JEDEC: TO-92
EIAJ: SC-43
SANYO: NP

G: Gate
S: Source
D: Drain
B: Base

Case Outline-[2012]

unit:mm

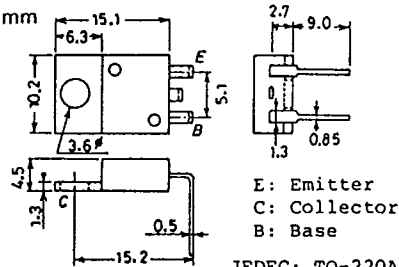

JEDEC: TO-220AA
EIAJ: SC-45

E: Emitter
C: Collector
B: Base

Case Outline-[2006A]

unit:mm

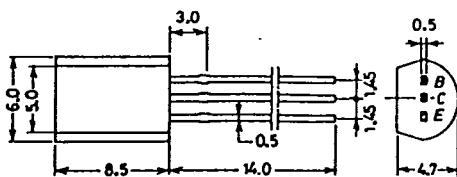

EIAJ: SC-51
SANYO: MP

B: Base
C: Collector
E: Emitter

Case Outline-[2013]

unit:mm

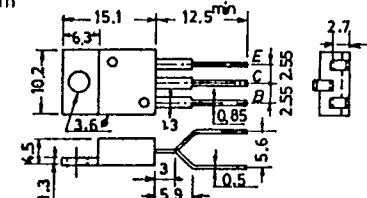

JEDEC TO-220

B: Base
C: Collector
E: Emitter

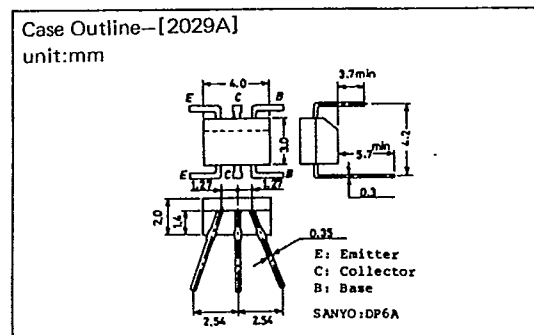
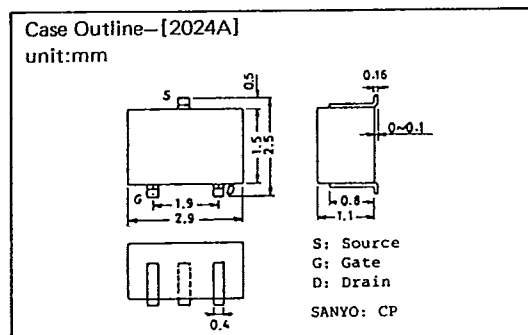
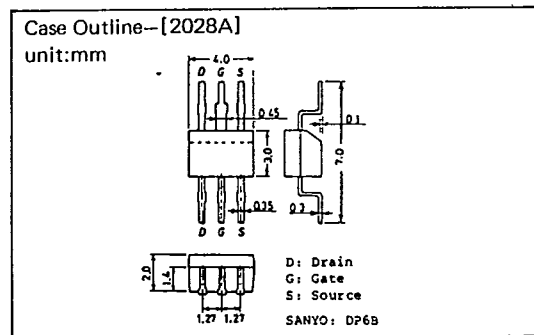
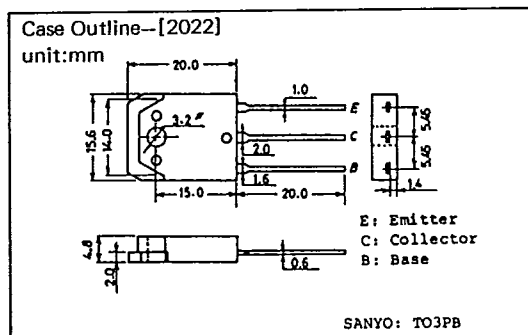
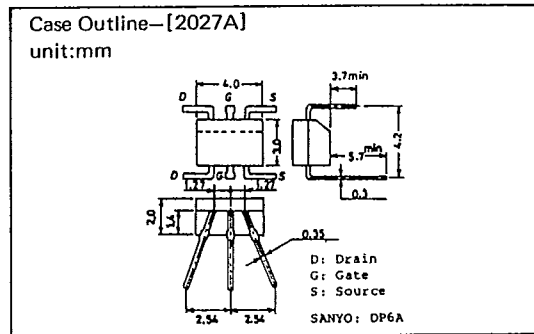
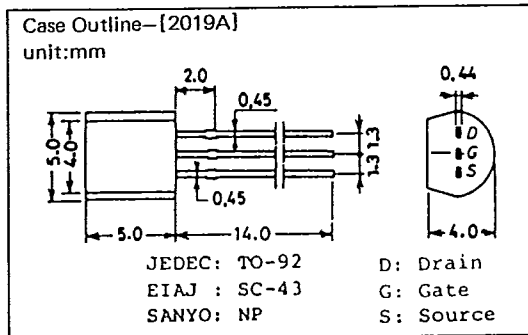
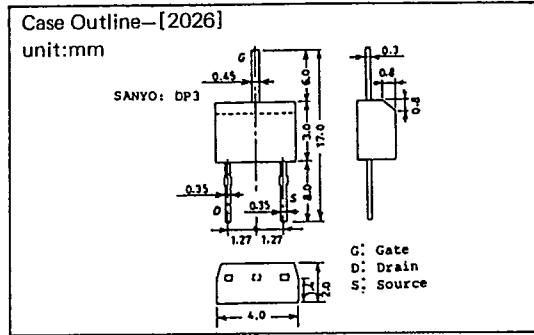
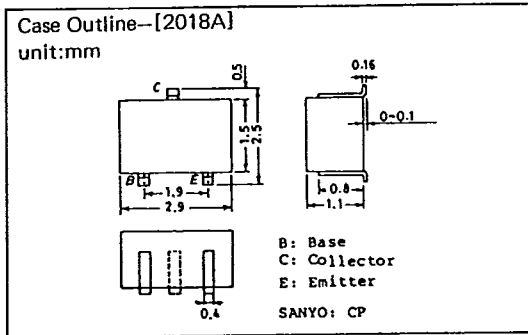
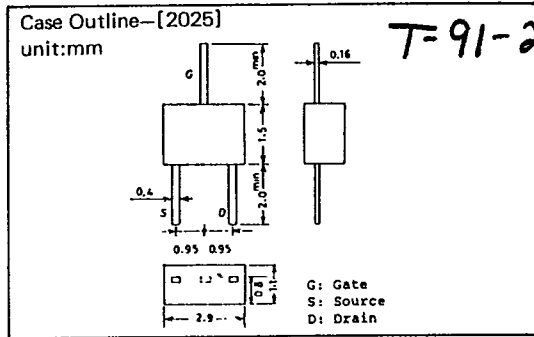
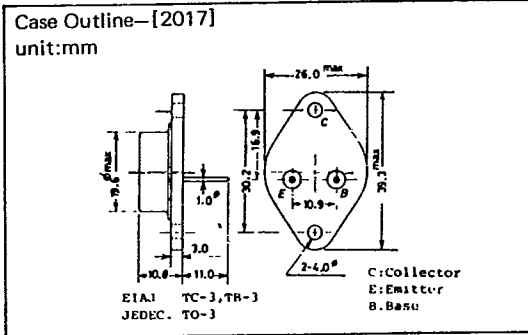

T-91-20

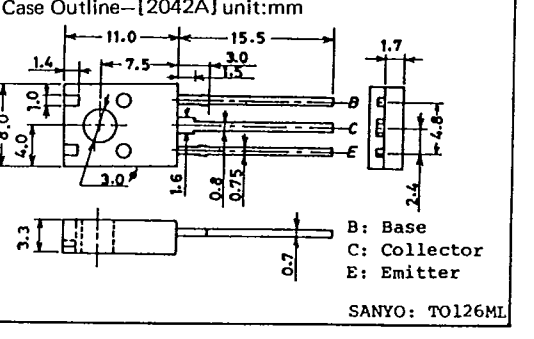
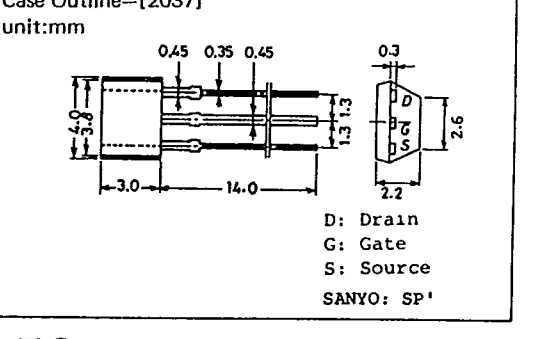
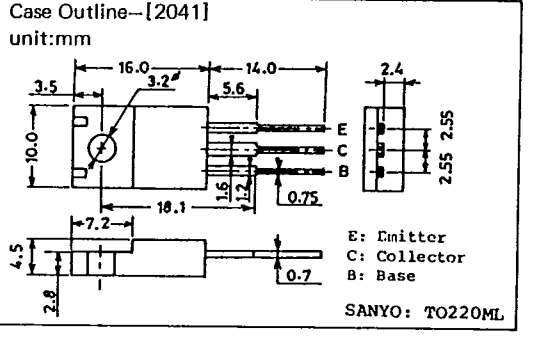
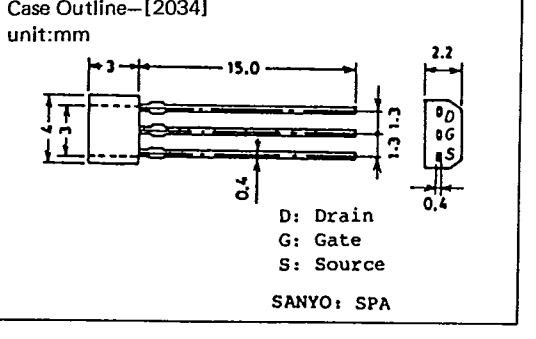
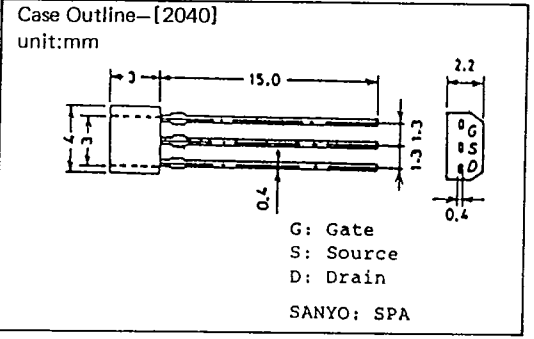
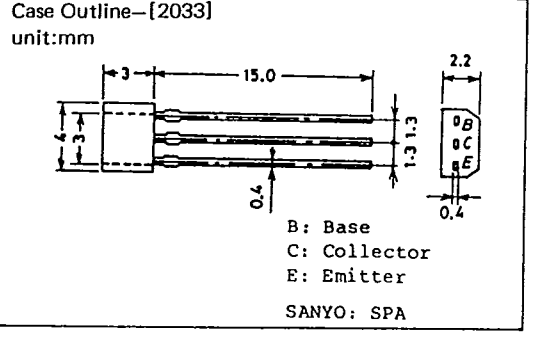
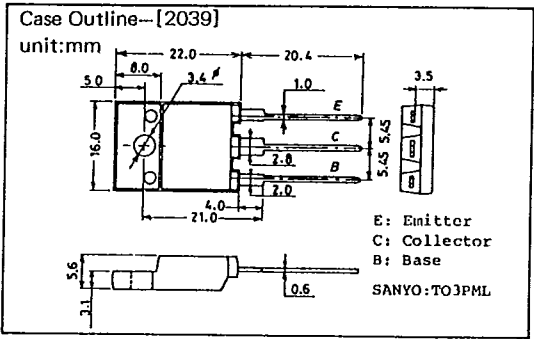
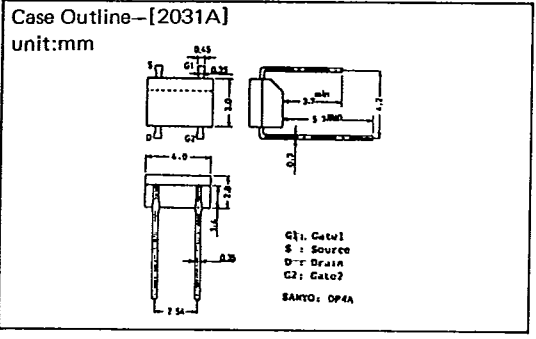
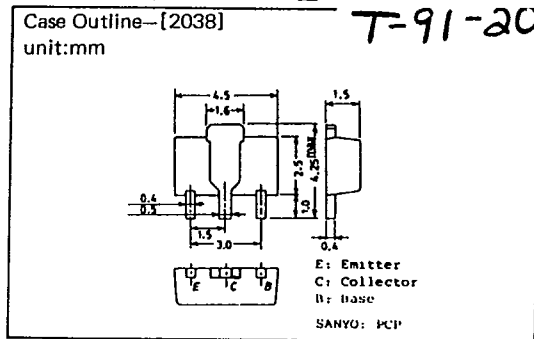
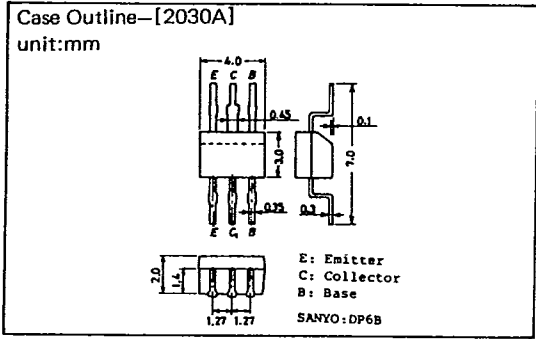

T-91-20

