

Silicon PNP Power Transistors

2SA1804

DESCRIPTION

- With TO-3PFM package
- Complement to type 2SC4689

APPLICATIONS

- Power amplifier applications
- Recommend for 55W high fidelity audio frequency amplifier output stage

PINNING(See Fig.2)

PIN	DESCRIPTION
1	Base
2	Collector
3	Emitter

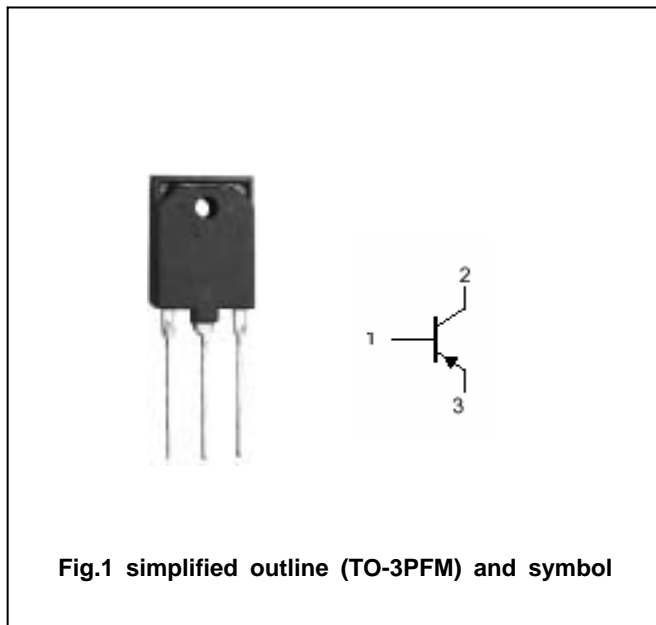

Absolute maximum ratings(Tc=25)

SYMBOL	PARAMETER	CONDITIONS	VALUE	UNIT
V_{CBO}	Collector-base voltage	Open emitter	-120	V
V_{CEO}	Collector-emitter voltage	Open base	-120	V
V_{EBO}	Emitter-base voltage	Open collector	-5	V
I_C	Collector current		-8	A
I_{CM}	Collector current-peak		-16	A
I_B	Base current		-0.8	A
P_C	Collector power dissipation	$T_C=25$	70	W
T_j	Junction temperature		150	
T_{stg}	Storage temperature		-55~150	

Silicon PNP Power Transistors

2SA1804

CHARACTERISTICS

T_j=25 unless otherwise specified

SYMBOL	PARAMETER	CONDITIONS	MIN	TYP.	MAX	UNIT
V _{(BR)CEO}	Collector-emitter breakdown voltage	I _C =-50mA; I _B =0	-120			V
V _{CEsat}	Collector-emitter saturation voltage	I _C =-6A; I _B =-0.6 A			-2.0	V
V _{BE}	Base-emitter voltage	I _C =-4A ; V _{CE} =-5V			-1.5	V
I _{CBO}	Collector cut-off current	V _{CB} =-120V ; I _E =0			-5	μ A
I _{EBO}	Emitter cut-off current	V _{EB} =-5V; I _C =0			-5	μ A
h _{FE-1}	DC current gain	I _C =-1A ; V _{CE} =-5V	55		160	
h _{FE-2}	DC current gain	I _C =-4A ; V _{CE} =-5V	35			
f _T	Transition frequency	I _C =-1A ; V _{CE} =-5V		30		MHz
C _{OB}	Output capacitance	I _E =0; V _{CB} =10V; f=1MHz		420		pF

◆ h_{FE} classifications

R	O
55-110	80-160

Silicon PNP Power Transistors

2SA1804

PACKAGE OUTLINE

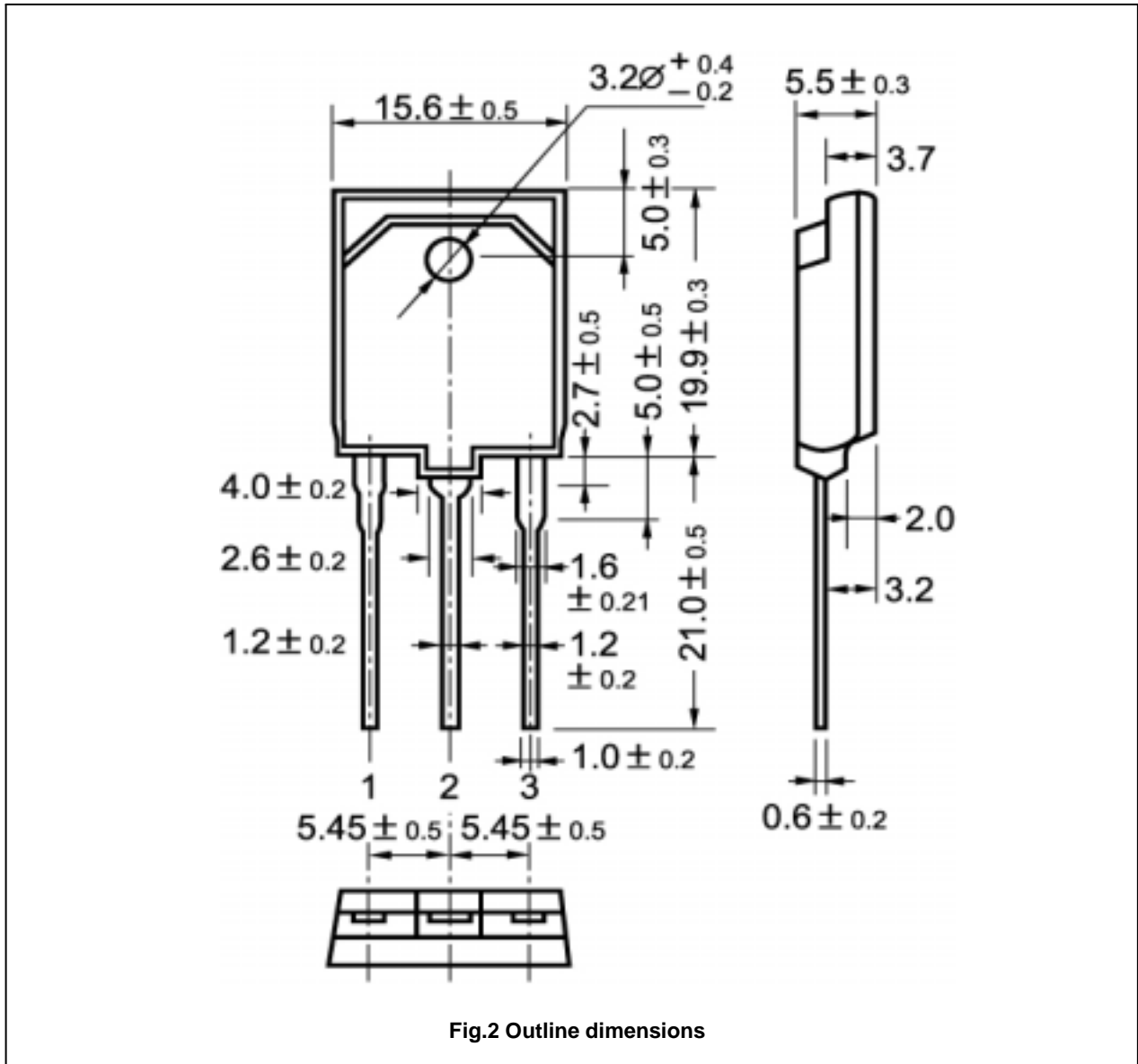

Fig.2 Outline dimensions

Silicon PNP Power Transistors

2SA1804

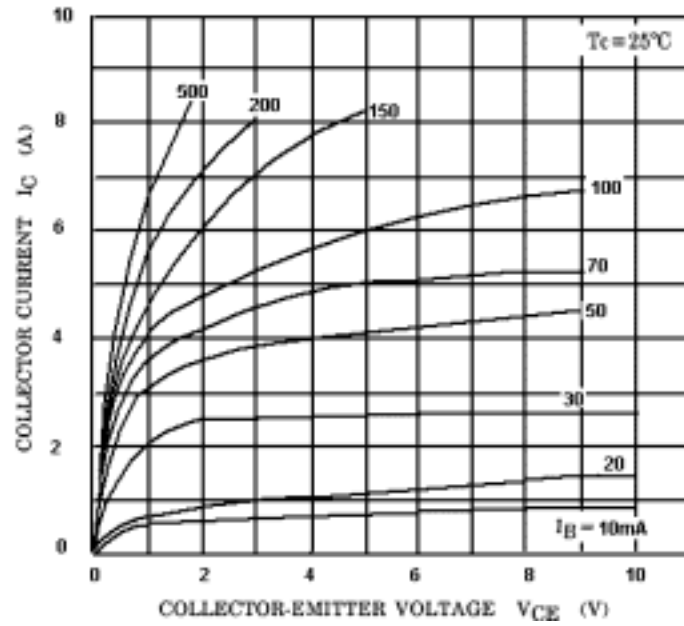

Fig.3 Static Characteristic

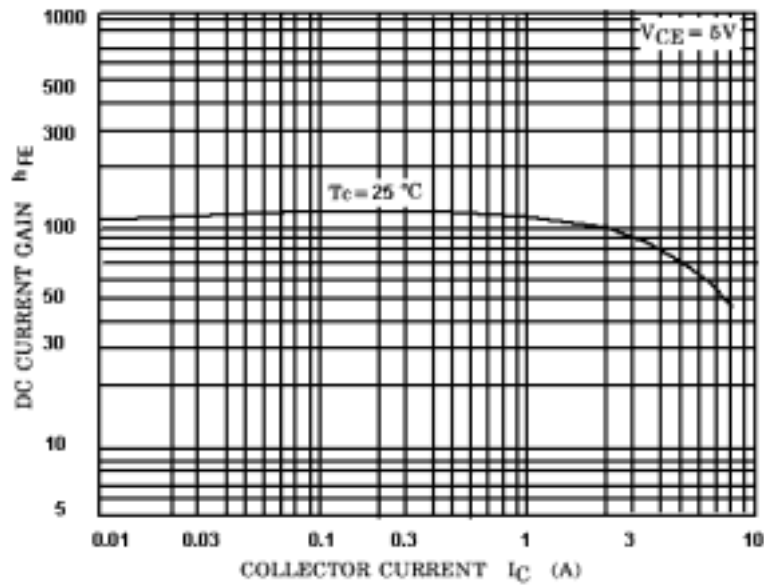

Fig.4 DC current Gain

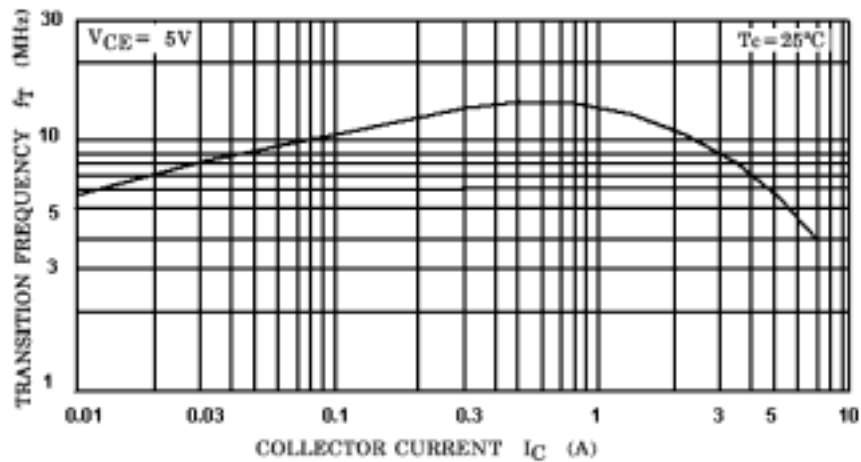

Fig.5 $f_T - I_C$

Silicon PNP Power Transistors

2SA1804

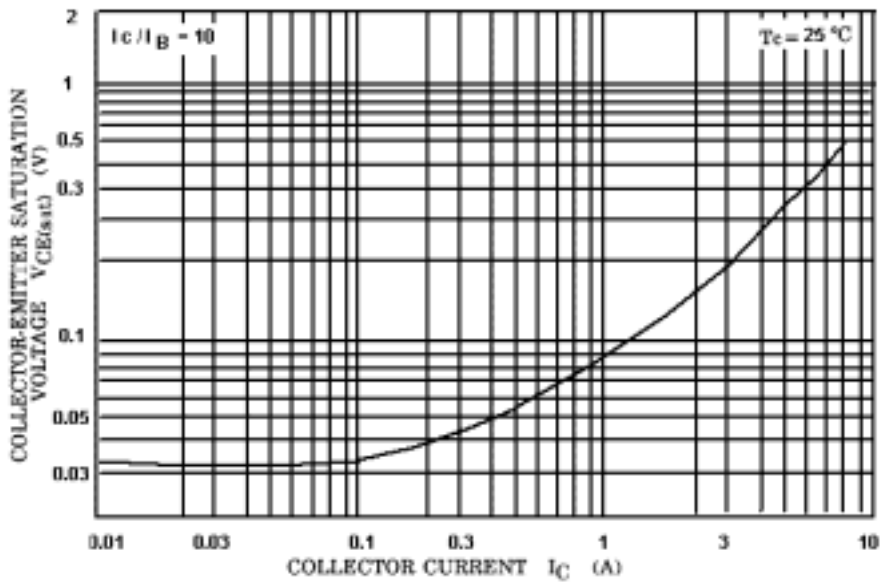

Fig.5 Collector-Emitter Saturation Voltage

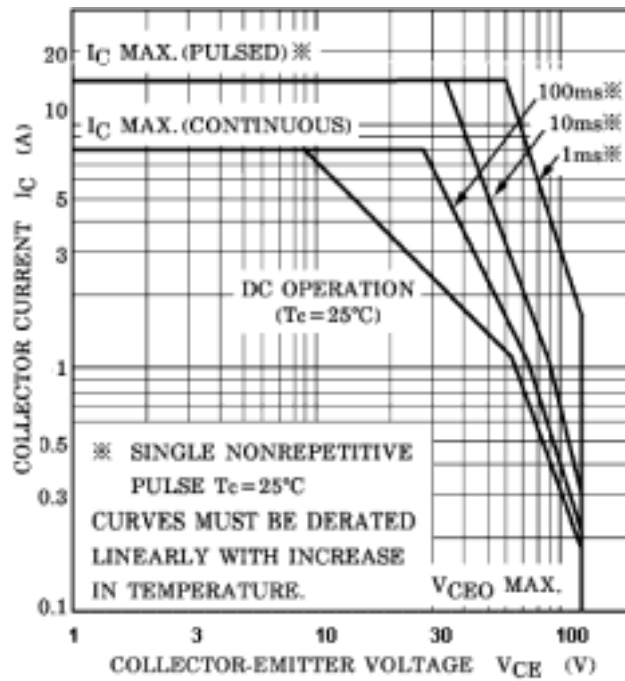

Fig.7 Safe Operating Area