

## High Speed Switching Application

### Features

- ESD rating: 1000V (HBM)
- Low On-Resistance:  $R_{DS(on)} < 3\Omega$  @  $V_{GS} = 10V$
- High power and current handling capability
- Very fast switching
- RoHS compliant device

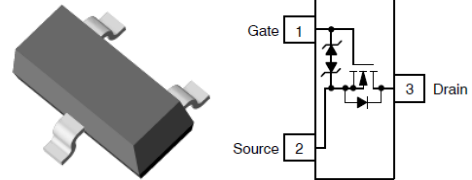

### Applications

- High speed line driver

**SOT-23**

### Ordering Information

Part Number	Marking Code	Package	Packaging
<b>2N7002K</b>	<b>7K2</b> □	<b>SOT-23</b>	<b>Tape &amp; Reel</b>

### Marking Information

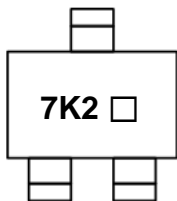
**7K2 = Specific Device Code**
**□ = Year & Week Code Marking**

### Absolute Maximum Ratings ( $T_{amb}=25^{\circ}C$ , Unless otherwise specified)

Characteristic	Symbol	Ratings	Unit
Drain-Source voltage	$V_{DS}$	60	V
Gate-Source voltage	$V_{GS}$	$\pm 20$	V
Maximum drain current <sup>(Note 1)</sup>	$I_D$	300	mA
Pulsed drain current <sup>(Note 1)</sup>	$I_{DP}$	800	mA
Power dissipation <sup>(Note 2)</sup>	$P_D$	350	mW
Operating junction temperature	$T_j$	150	$^{\circ}C$
Storage temperature range	$T_{stg}$	-55 ~ 150	$^{\circ}C$
Thermal resistance junction to ambient <sup>(Note 2)</sup>	$R_{th(j-a)}$	350	$^{\circ}C/W$

Note 1) Limited only maximum junction temperature

Note 2) Device mounted on FR-4 board with recommended pad layout.

## Electrical Characteristics (T<sub>amb</sub>=25°C, Unless otherwise specified)

Characteristic	Symbol	Test Condition	Min.	Typ.	Max.	Unit
Drain-Source breakdown voltage	BV <sub>DSS</sub>	I <sub>D</sub> =250μA, V <sub>GS</sub> =0	60	-	-	V
Gate-Source breakdown voltage	BV <sub>GSS</sub>	I <sub>G</sub> =250μA, V <sub>DS</sub> =0	±20	-	-	V
Gate-Threshold voltage	V <sub>GS(th)</sub>	I <sub>D</sub> =250μA, V <sub>DS</sub> =V <sub>GS</sub>	1	-	2.5	V
Zero Gate voltage drain current	I <sub>DSS</sub>	V <sub>DS</sub> =60V, V <sub>GS</sub> =0	-	-	1	μA
Gate-body leakage	I <sub>GSS</sub>	V <sub>GS</sub> =±5V, V <sub>DS</sub> =0V	-	-	±100	nA
		V <sub>GS</sub> =±10V, V <sub>DS</sub> =0V	-	-	±150	nA
		V <sub>GS</sub> =±20V, V <sub>DS</sub> =0V	-	-	±10	μA
Drain-Source on-resistance (Note 3)	R <sub>DS(on)</sub>	V <sub>GS</sub> =10V, I <sub>D</sub> =0.5A	-	-	3	Ω
		V <sub>GS</sub> =5V, I <sub>D</sub> =0.05A	-	-	3.5	
Forward trans-conductance (Note 3)	g <sub>fs</sub>	V <sub>DS</sub> =10V, I <sub>D</sub> =0.2A	0.08	-	-	S
Input capacitance	C <sub>iss</sub>	V <sub>DS</sub> =25V, V <sub>GS</sub> =0, f=1MHz	-	30	50	pF
Output capacitance	C <sub>oss</sub>		-	7	-	
Reverse Transfer capacitance	C <sub>rss</sub>		-	4	-	
Turn-on delay time (Note 3, 4)	t <sub>d(on)</sub>	V <sub>DD</sub> =30V, I <sub>D</sub> =0.2A, V <sub>GS</sub> =10V, R <sub>G</sub> =10Ω	-	2	-	ns
Rise time (Note 3, 4)	t <sub>r</sub>		-	15	-	
Turn-off delay time (Note 3, 4)	t <sub>d(off)</sub>		-	8	-	
Fall time (Note 3, 4)	t <sub>f</sub>		-	11	-	
Total gate charge (Note 3, 4)	Q <sub>g</sub>	V <sub>DS</sub> =10V, I <sub>D</sub> =0.25A, V <sub>GS</sub> =4.5V	-	0.6	0.8	nC
Gate-Source charge (Note 3, 4)	Q <sub>gs</sub>		-	0.2	-	
Gate-Drain charge (Note 3, 4)	Q <sub>gd</sub>		-	0.2	-	
Diode forward voltage (Note 3)	V <sub>SD</sub>	V <sub>GS</sub> =0V, I <sub>S</sub> =0.2A	-	-	1.3	V

Note 3) Pulse test: Pulse width ≤ 300μs, Duty cycle ≤ 2%

Note 4) Essentially independent of operating temperature typical characteristics.

## Electrical Characteristics Curves

Fig. 1  $I_D - V_{DS}$

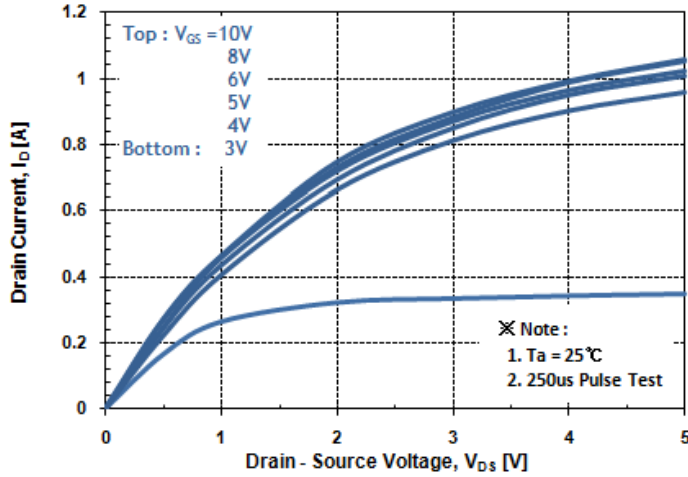

Fig. 2  $I_D - V_{GS}$

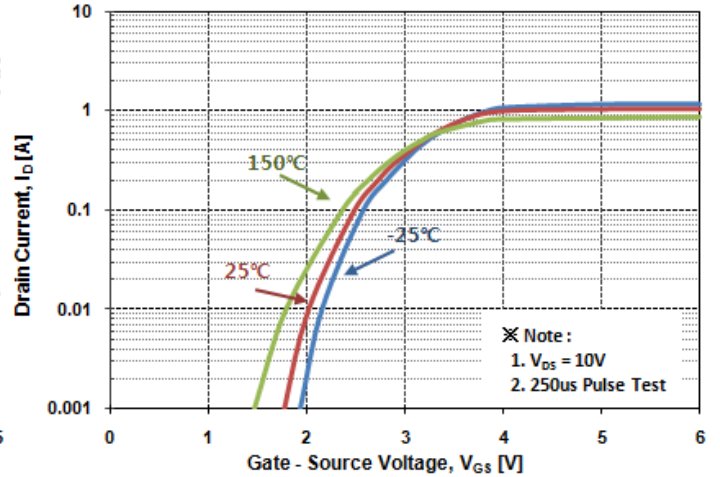

Fig. 3  $R_{DS(ON)} - I_D$

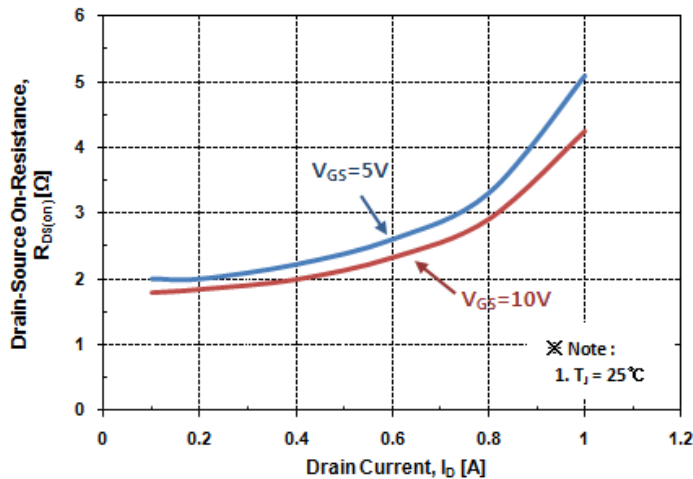

Fig. 4  $I_S - V_{SD}$

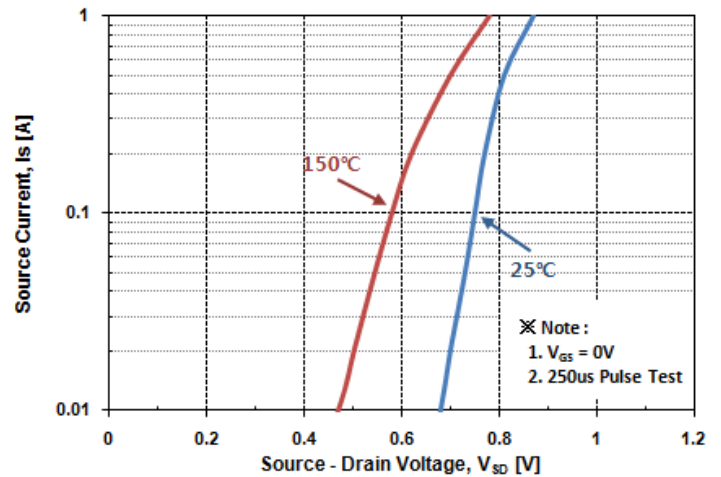

Fig. 5 Capacitance -  $V_{DS}$

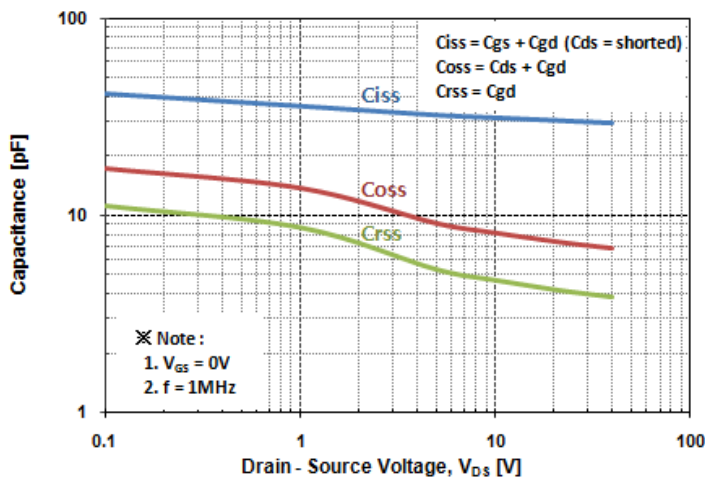

Fig. 6  $V_{GS} - Q_G$

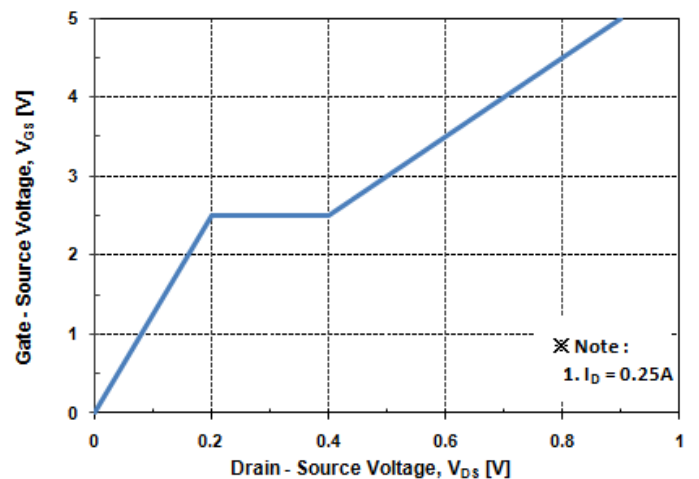

Fig. 7  $V_{DSS} - T_J$

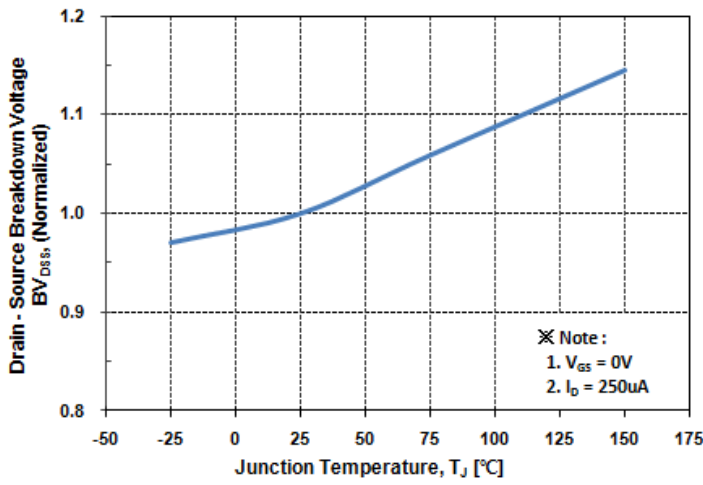

Fig. 8  $R_{DS(on)} - T_J$

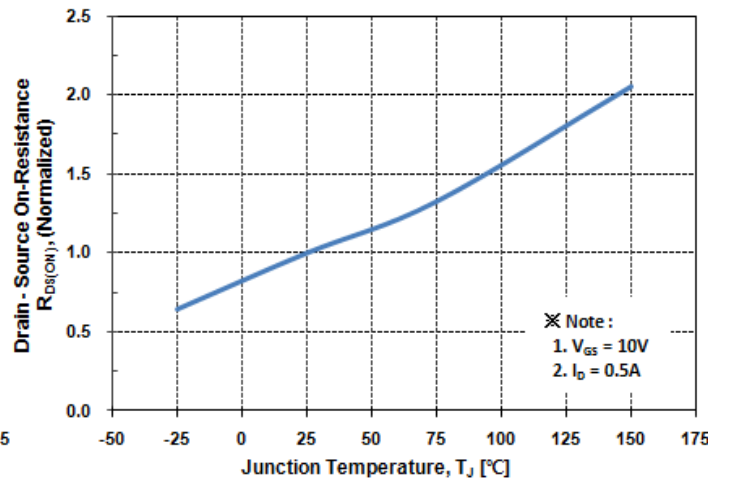

Fig. 9  $I_D - T_C$

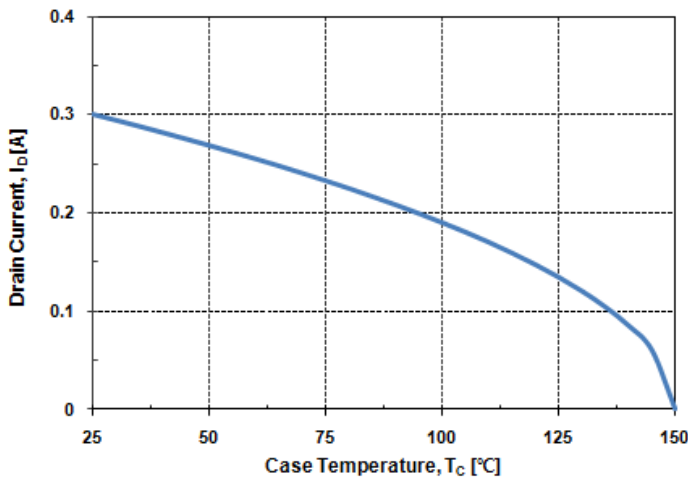

Fig. 10 Safe Operating Area

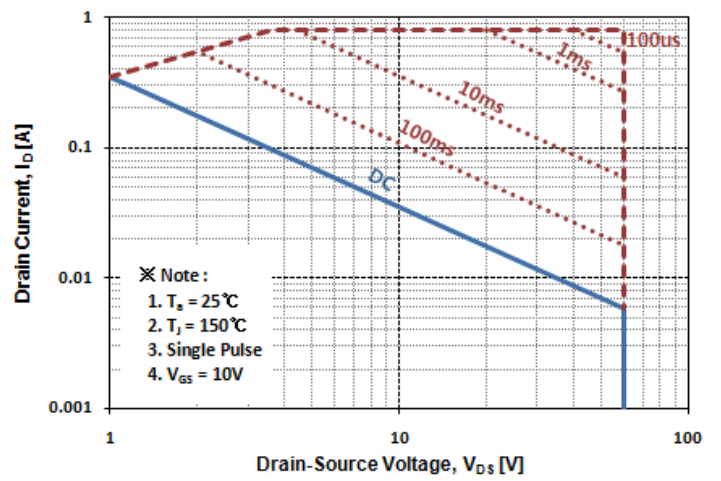
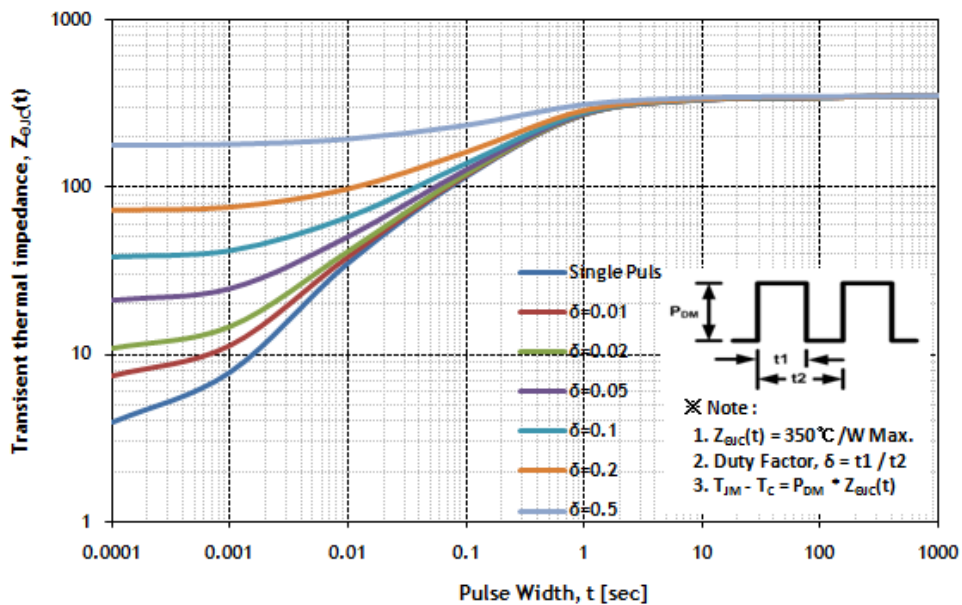
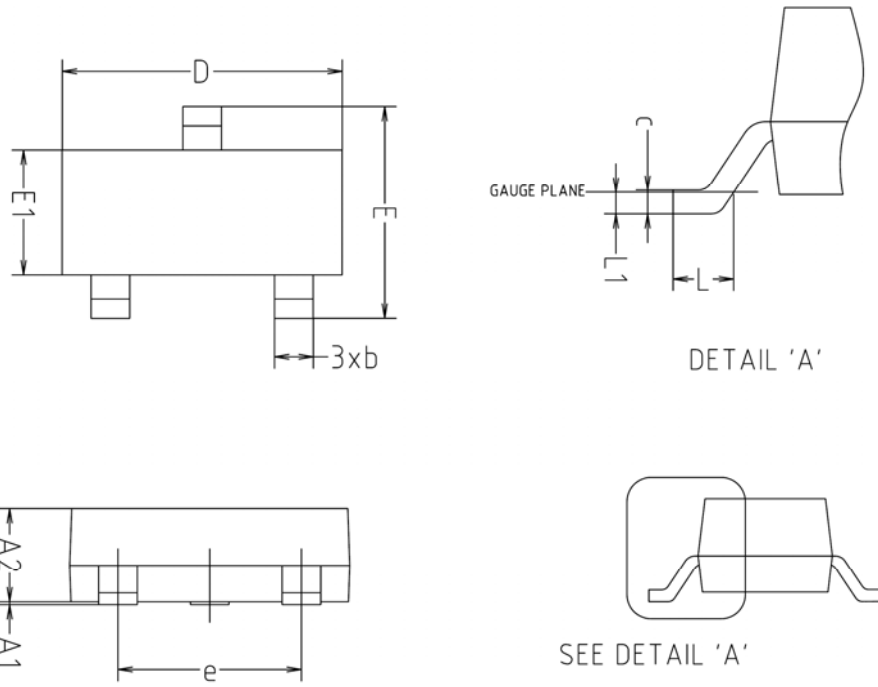

Fig. 11 Transient Thermal Impedance



Package Outline Dimensions



SYMBOL	MILLIMETERS			NOTE
	MINIMUM	NOMINAL	MAXIMUM	
A1	0.00	-	0.10	
A2	0.82	-	1.02	
b	0.39	0.42	0.45	
c	0.09	0.12	0.15	
D	2.80	2.90	3.00	
E	2.20	2.40	2.60	
E1	1.20	1.30	1.40	
e	1.90BSC			
L	0.20	-	-	
L1	0.12BSC			

※ Recommend PCB solder land (Unit: mm)

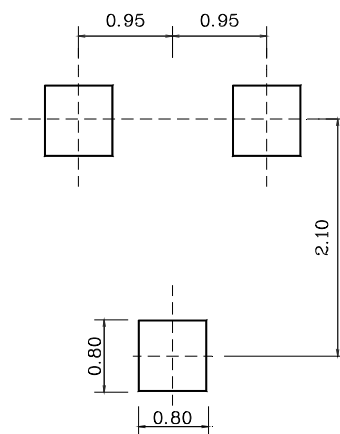

**The AUK Corp. products are intended for the use as components in general electronic equipment (Office and communication equipment, measuring equipment, home appliance, etc.).**

**Please make sure that you consult with us before you use these AUK Corp. products in equipments which require high quality and / or reliability, and in equipments which could have major impact to the welfare of human life(atomic energy control, airplane, spaceship, transportation, combustion control, all types of safety device, etc.). AUK Corp. cannot accept liability to any damage which may occur in case these AUK Corp. products were used in the mentioned equipments without prior consultation with AUK Corp..**

**Specifications mentioned in this publication are subject to change without notice.**