

2N2222AU

NPN Silicon Epitaxial Planar Transistor

for switching and AF amplifier applications.

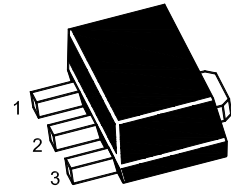

1.Base 2.Collector 3.Emitter
SOT-89 Plastic Package

Absolute Maximum Ratings ($T_a = 25^\circ\text{C}$)

Parameter	Symbol	Value	Unit
Collector Base Voltage	V_{CBO}	75	V
Collector Emitter Voltage	V_{CEO}	40	V
Emitter Base Voltage	V_{EBO}	6	V
Collector Current	I_C	600	mA
Power Dissipation	P_{tot}	625	mW
Junction Temperature	T_j	150	$^\circ\text{C}$
Storage Temperature Range	T_{stg}	- 55 to + 150	$^\circ\text{C}$

Characteristics at $T_a = 25^\circ\text{C}$

Parameter	Symbol	Min.	Max.	Unit
DC Current Gain at $V_{CE} = 10\text{ V}$, $I_C = 0.1\text{ mA}$	h_{FE}	35	-	-
at $V_{CE} = 10\text{ V}$, $I_C = 1\text{ mA}$	h_{FE}	50	-	-
at $V_{CE} = 10\text{ V}$, $I_C = 10\text{ mA}$	h_{FE}	75	-	-
at $V_{CE} = 10\text{ V}$, $I_C = 150\text{ mA}$	h_{FE}	100	300	-
at $V_{CE} = 10\text{ V}$, $I_C = 500\text{ mA}$	h_{FE}	40	-	-
Collector Base Cutoff Current at $V_{CB} = 60\text{ V}$	I_{CBO}	-	10	nA
Collector Base Breakdown Voltage at $I_C = 10\text{ }\mu\text{A}$	$V_{(BR)CBO}$	75	-	V
Collector Emitter Breakdown Voltage at $I_C = 10\text{ mA}$	$V_{(BR)CEO}$	40	-	V
Emitter Base Breakdown Voltage at $I_E = 10\text{ }\mu\text{A}$	$V_{(BR)EBO}$	6	-	V
Collector Emitter Saturation Voltage at $I_C = 150\text{ mA}$, $I_B = 15\text{ mA}$	$V_{CE(sat)}$	-	0.3	V
at $I_C = 500\text{ mA}$, $I_B = 50\text{ mA}$		-	1	
Base Emitter Saturation Voltage at $I_C = 150\text{ mA}$, $I_B = 15\text{ mA}$	$V_{BE(sat)}$	0.6	1.2	V
at $I_C = 500\text{ mA}$, $I_B = 50\text{ mA}$		-	2	
Gain Bandwidth Product at $I_C = 20\text{ mA}$, $V_{CE} = 20\text{ V}$, $f = 100\text{ MHz}$	f_T	250	-	MHz
Collector Output Capacitance at $V_{CB} = 10\text{ V}$, $f = 1\text{ MHz}$	C_{ob}	-	8	pF

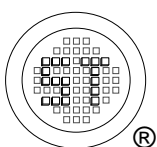

SEMTECH ELECTRONICS LTD.



ISO 9001 : 2008
Certificate No. 18073388



ISO 14001 : 2004
Certificate No. 7116



ISO 9001 : 2008
Certificate No. 8071940



BS-ENAS 18001 : 2007
Certificate No. 7116



IECQ QC 080000
Certificate No. P16-18784-1483-1

Dated: 18/01/2016 Rev: 03

Figure 1. DC Current Gain

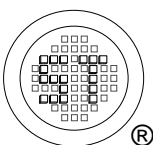
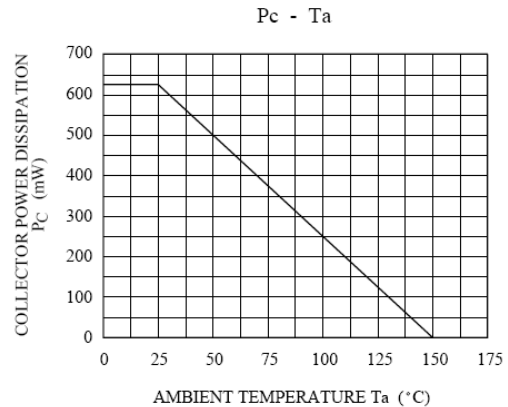
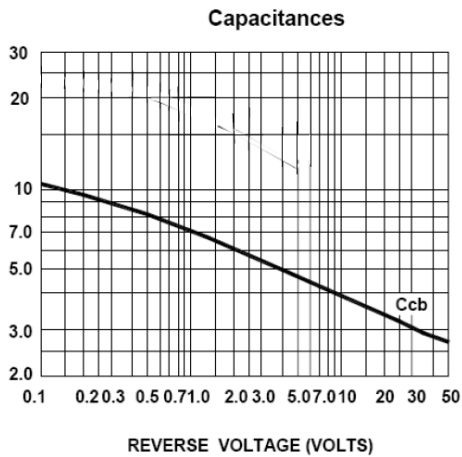
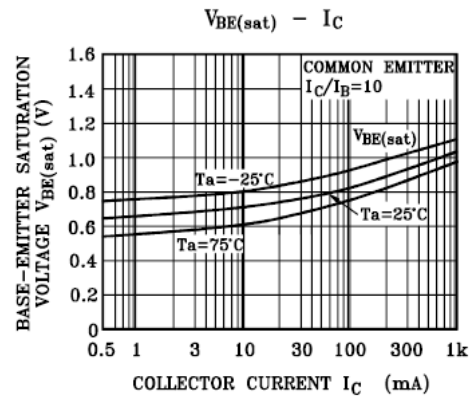
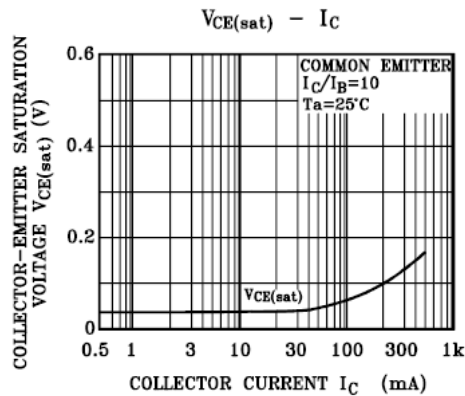
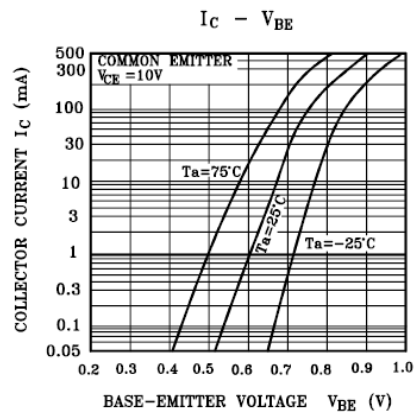
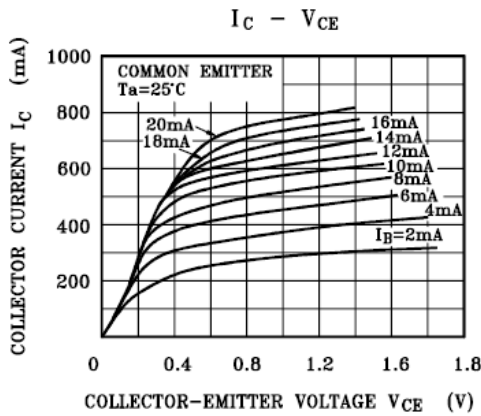
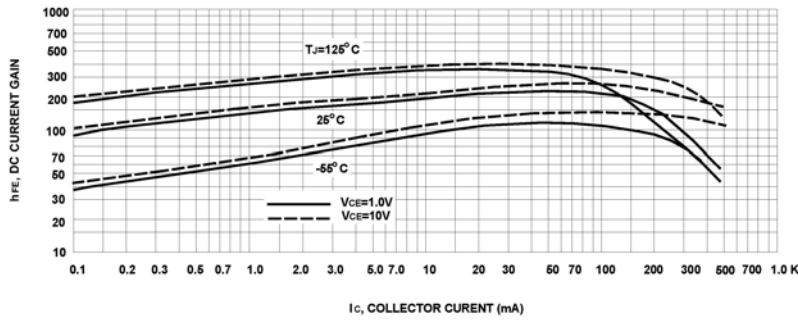

SEMTECH ELECTRONICS LTD.



2N2222AU

SOT-89 PACKAGE OUTLINE

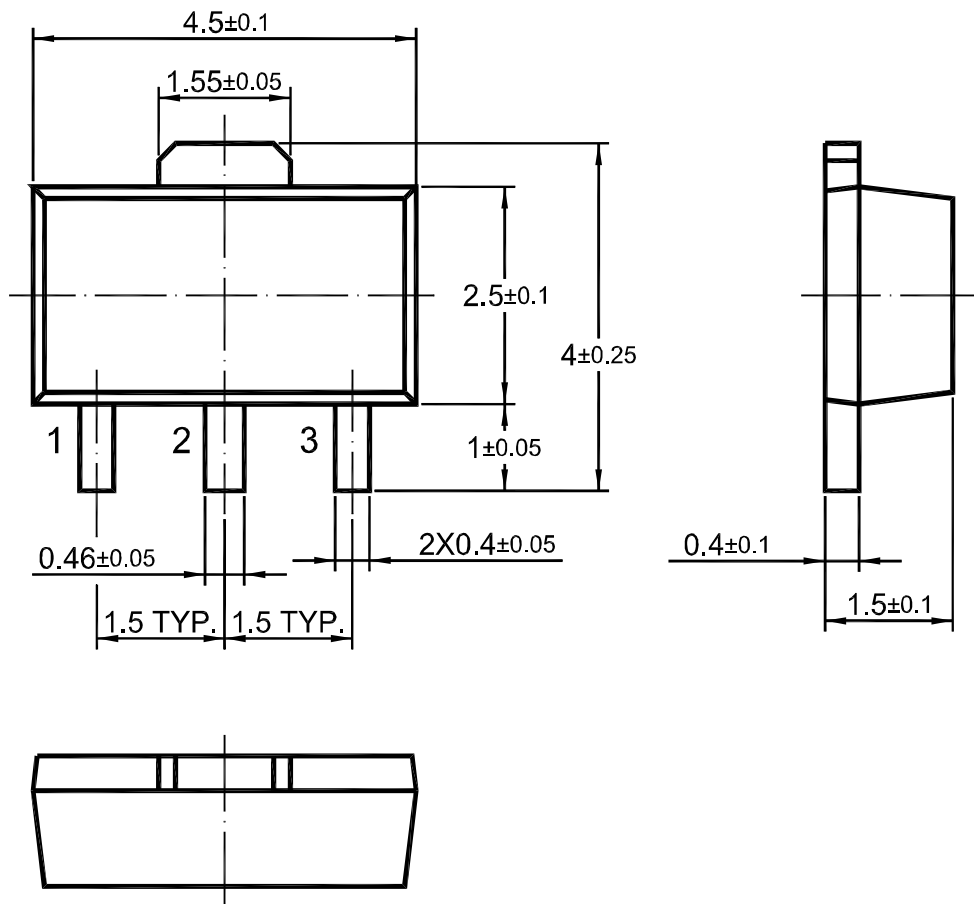

Dimensions in mm

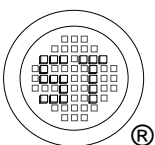

SEMTECH ELECTRONICS LTD.



ISO 9001 : 2008
Certificate No. 18073388



ISO 14001 : 2004
Certificate No. 7116



ISO 9001 : 2008
Certificate No. 80719410



BS-ENAS 18001 : 2007
Certificate No. 7116

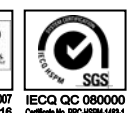

IECQ QC 080000
Certificate No. PRC-18274-1453-1

Dated: 18/01/2016 Rev: 03