

IGBT MODULE (F series)

■ Features

- Low Saturation Voltage
- Voltage Drive
- Variety of Power Capacity Series

■ Applications

- Inverter for Motor Drive
- AC and DC Servo Drive Amplifier
- Uninterruptible Power Supply
- Industrial Machines, such as Welding Machines

■ Maximum Ratings and Characteristics

● Absolute Maximum Ratings

Items	Symbols	Ratings	Units	
Collector-Emitter Voltage	V_{CES}	1200	V	
Gate-Emitter Voltage	V_{GES}	± 20	V	
Collector Current	Continuous	150	A	
	1ms	$I_{C\ pulse}$		300
	Continuous	$-I_C$		150
	1ms	$-I_{C\ pulse}$		300
Max. Power Dissipation	P_C	1080	W	
Operating Temperature	T_j	+150	$^{\circ}C$	
Storage Temperature	T_{stg}	-40 to +125	$^{\circ}C$	
Net. Weight		400	g	
Isolation Voltage	AC. 1min.	V_{isol}	2500 V	
Screw Torque	Mounting *1	3.5 {35}	N · m	
	Terminals *1	3.5 {35}	{kg · cm}	

*1 Recommendable Value 2.5 to 3.5 N·m {25 to 35 kg·cm} (M5)

● Electrical Characteristics ($T_C=25^{\circ}C$)

Items	Symbols	Test Conditions	Min.	Typ.	Max.	Units
Zero Gate Voltage Collector Current	I_{CES}	$V_{GE}=0V$ $V_{CE}=1200V$ $T_j=25^{\circ}C$			1.0	mA
		$V_{GE}=0V$ $V_{CE}=1200V$ $T_j=125^{\circ}C$			—	mA
Gate-Emitter Leakage Current	I_{GES}	$V_{CE}=0V$ $V_{GE}=\pm 20V$			200	nA
Gate-Emitter Threshold Voltage	$V_{GE(th)}$	$V_{CE}=20V$ $I_C=150mA$	3.0		6.0	V
Collector-Emitter Saturation Voltage	$V_{CE(sat)}$	$V_{GE}=15V$ $I_C=150A$			2.5	V
Input Capacitance	C_{ies}	$V_{GE}=0V$		27000		pF
Output Capacitance	C_{oes}	$V_{CE}=10V$		—		
Reverse Transfer Capacitance	C_{res}	$f=1MHz$		—		
Turn-on Time	t_{on}	$V_{CC}=600V$ $I_C=150A$	Resistive load		0.8	μs
	t_r				0.6	
Turn-off Time	t_{off}	$V_{GE}=\pm 15V$ $R_G=5.6\Omega$	Inductive load		1.5	
	t_f				1.0	
Diode Forward On-Voltage	V_F	$I_F=150A$, $V_{GE}=0V$			2.5	V
Reverse Recovery Time	t_{rr}	$I_F=150A$, $-di/dt=450A/\mu s$ $V_{GE}=-10V$			350	ns

● Thermal Characteristics

Items	Symbols	Test Conditions	Min.	Typ.	Max.	Units
Thermal Resistance	$R_{th(j-c)}$	IGBT			0.116	$^{\circ}C/W$
	$R_{th(j-c)}$	Diode			0.222	
	$R_{th(c-f)}$	With Thermal compound		0.025		

■ Outline Drawings

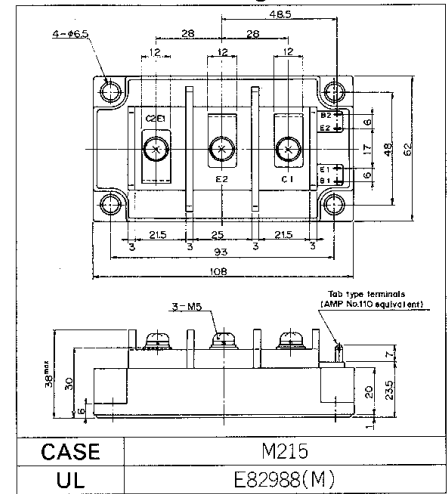

■ Equivalent Circuit Schematic

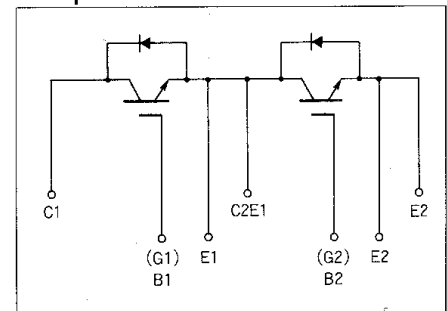

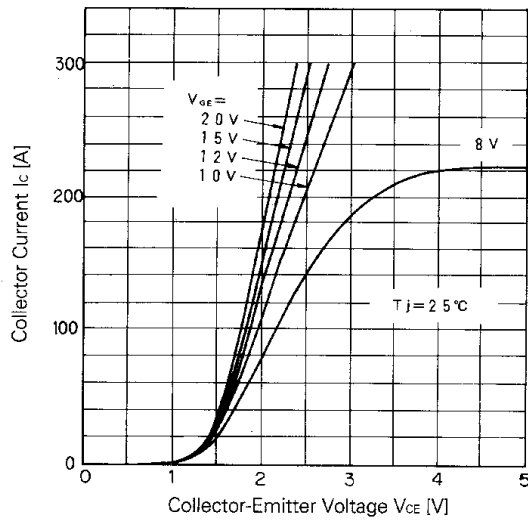

Collector Current vs. Collector-Emitter Voltage

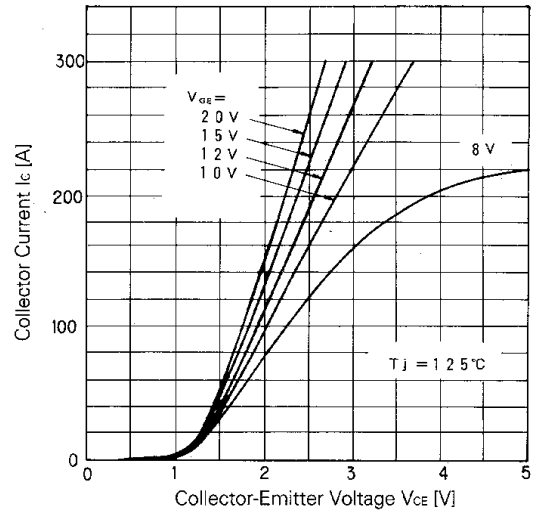

Collector Current vs. Collector-Emitter Voltage

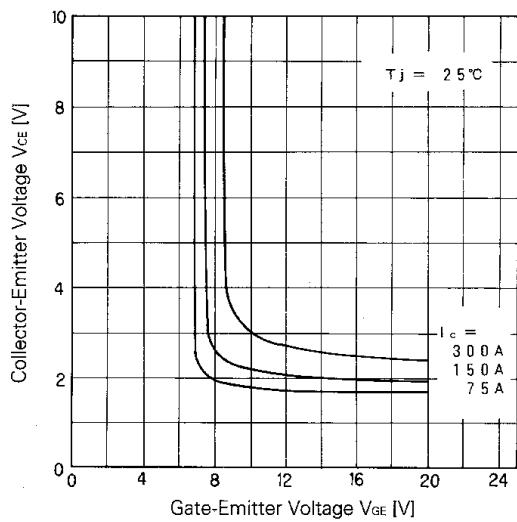

Collector-Emitter Voltage vs. Gate-Emitter Voltage

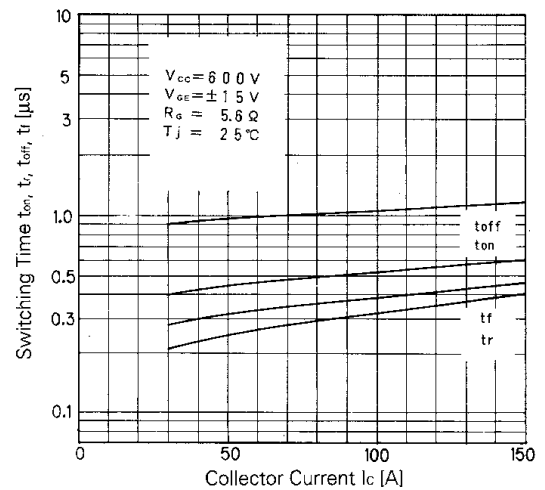

Switching Time

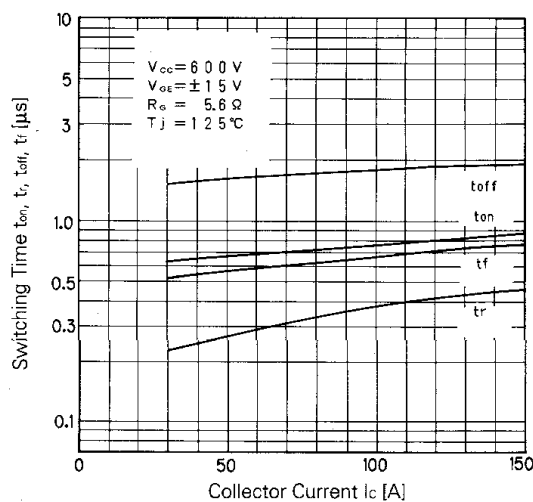

Switching Time

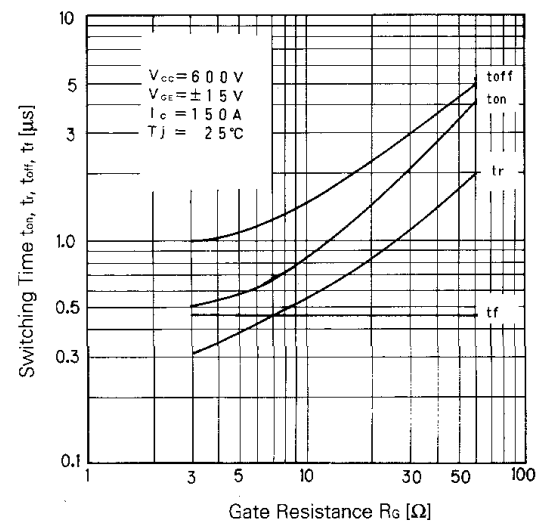

Switching Time-Gate Resistance

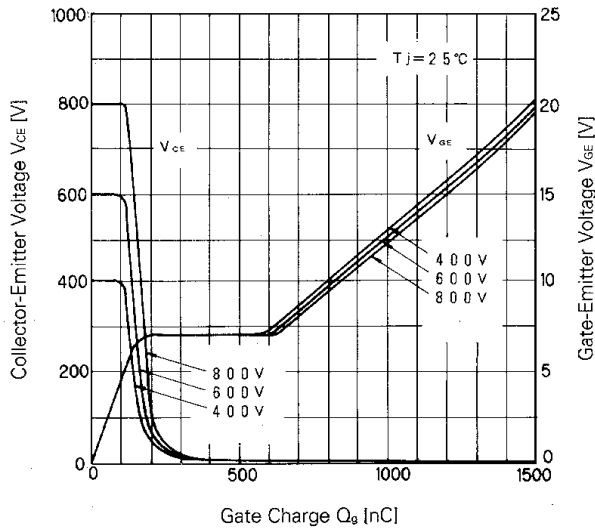

Dynamic Input Characteristic

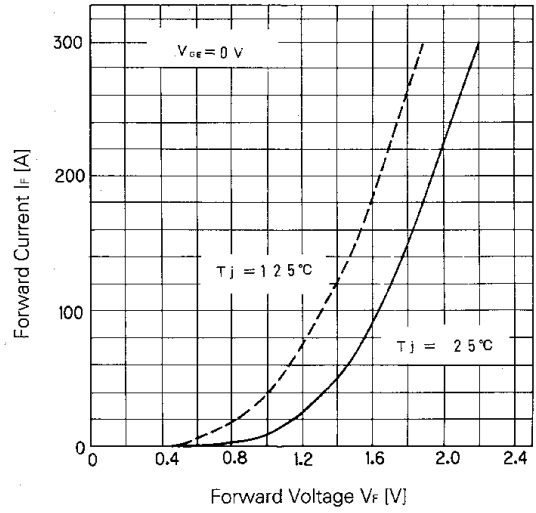

Forward Voltage of Free Wheel Diode

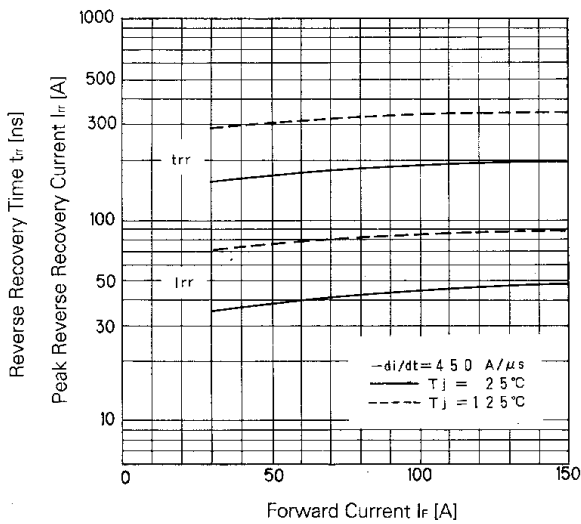

$T_{rr}, I_{rr} - I_f$

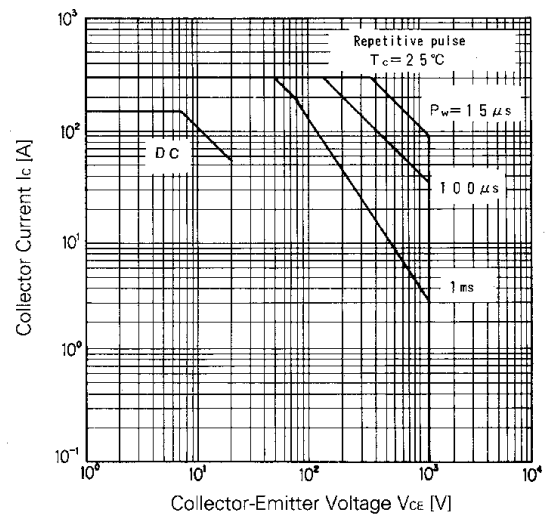

Safe Operating Area

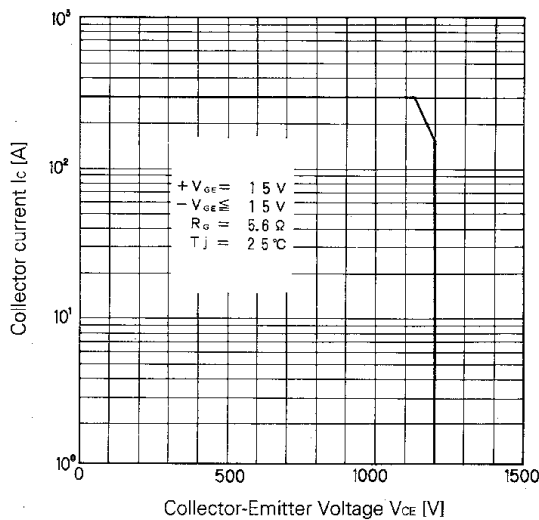

Reverse Biased Safe Operating Area

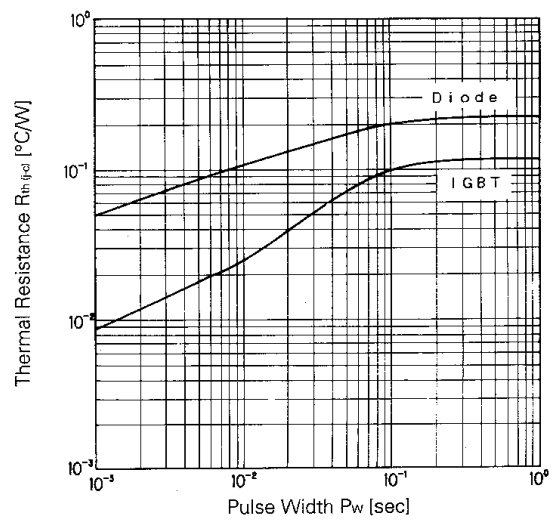

Transient Thermal Resistance

For more information, contact:

Collmer Semiconductor, Inc.

P.O. Box 702708

Dallas, TX 75370

972-733-1700

972-381-9991 Fax

<http://www.collmer.com>