



FEATURES

- Custom sizing
- Encapsulated by epoxy resin
- Corrosion resistance
- Op Temp -40°C to +120°C
- T_{RR}: -40°C to +120°C



APPLICATIONS

- Electrostatic precipitator
- High voltage generators
- High voltage testing

SCHEMATIC

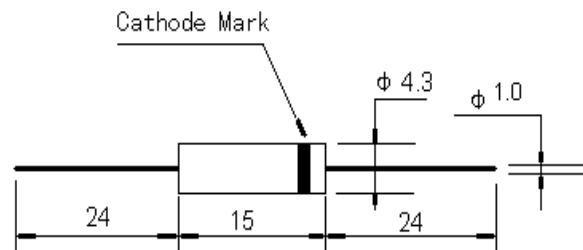

SPECIFICATIONS

Type	Repetitive Peak Reverse Voltage	Average Forward Current	Forward Peak Voltage	Surge Forward Current	Peak Reverse Current		Reverse Recovery Time
					Ta=25°C	Ta=100°C	
	KV	mA	V	A	μ A	μ A	nS
2CL8KV/100mA	8	100	9.0	20	2.0	40	–
2CL10KV/100mA	10	100	11.0	20	2.0	40	–
2CL12KV/100mA	12	100	13.0	20	2.0	40	–
2CL15KV/100mA	15	100	16.0	20	2.0	40	–
2CLG8KV/100mA	8	100	16.0	20	2.0	50	100
2CLG10KV/100mA	10	100	22.0	20	2.0	50	100
2CLG12KV/100mA	12	100	24.0	20	2.0	50	100
2CLG15KV/100mA	15	100	26.0	20	2.0	50	100
2CLG20KV/100mA	20	100	33.0	20	2.0	50	100





REVERSE RECOVERY TIME TEST CIRCUIT

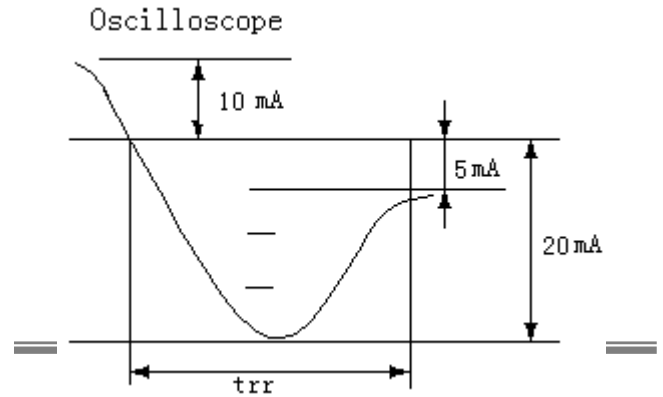
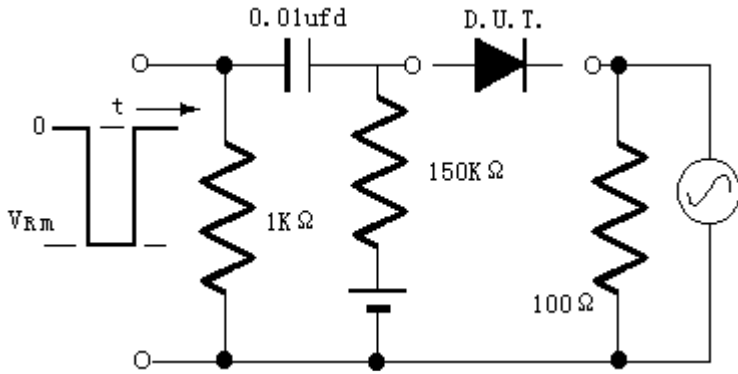

CHARACTERISTIC CURVATURES

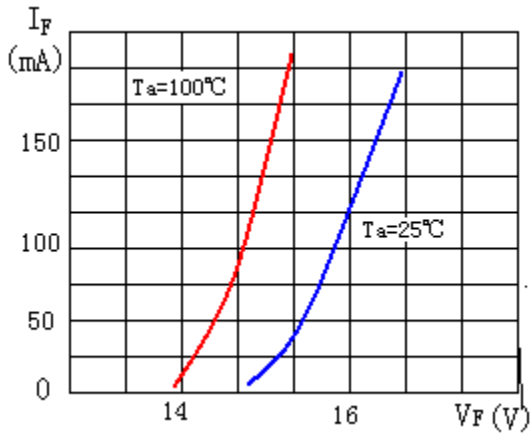

(2CL15KV/100mA) Forward Characteristics

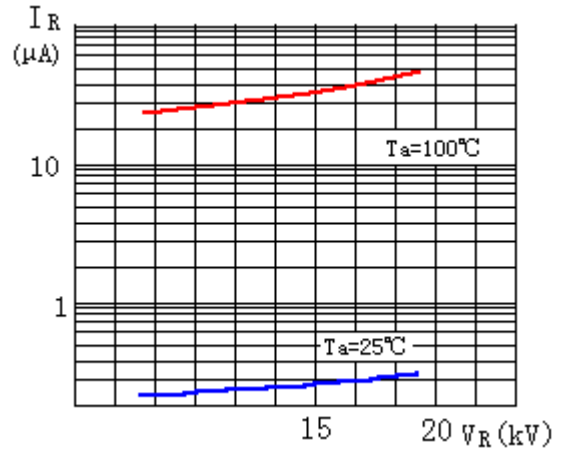

(2CL15KV/100mA) Reverse Characteristics

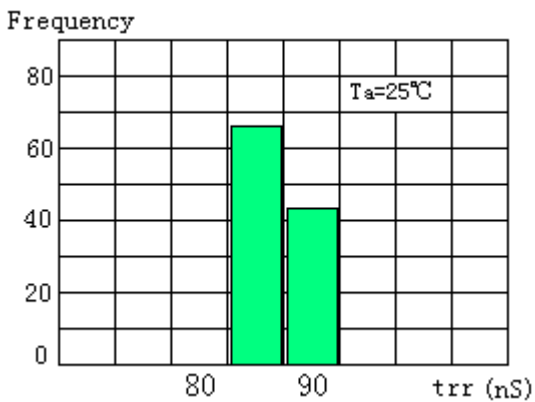

Reverse Recovery Time Distribution

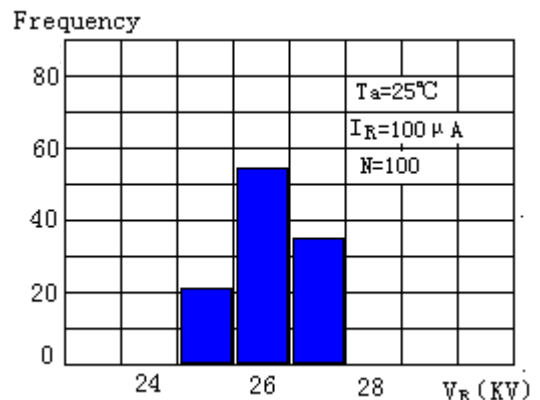

Avalanche Breakdown Voltage Distribution

