

Major Ratings and Characteristics

Characteristics	Values	Units
$I_{F(AV)}$ Rectangular waveform	1.0	A
V_{RRM}	30/40	V
I_{FSM} @ $t_p = 5 \mu s$ sine	225	A
V_F @1 Apk, $T_J = 25^\circ C$	0.55	V
T_J range	-40 to 150	$^\circ C$

Description/Features

The 1N5818/ 1N5819 axial leaded Schottky rectifier has been optimized for very low forward voltage drop, with moderate leakage. Typical applications are in switching power supplies, converters, free-wheeling diodes, and reverse battery protection.

- Low profile, axial leaded outline
- High purity, high temperature epoxy encapsulation for enhanced mechanical strength and moisture resistance
- Very low forward voltage drop
- High frequency operation
- Guard ring for enhanced ruggedness and long term reliability
- Lead-Free plating

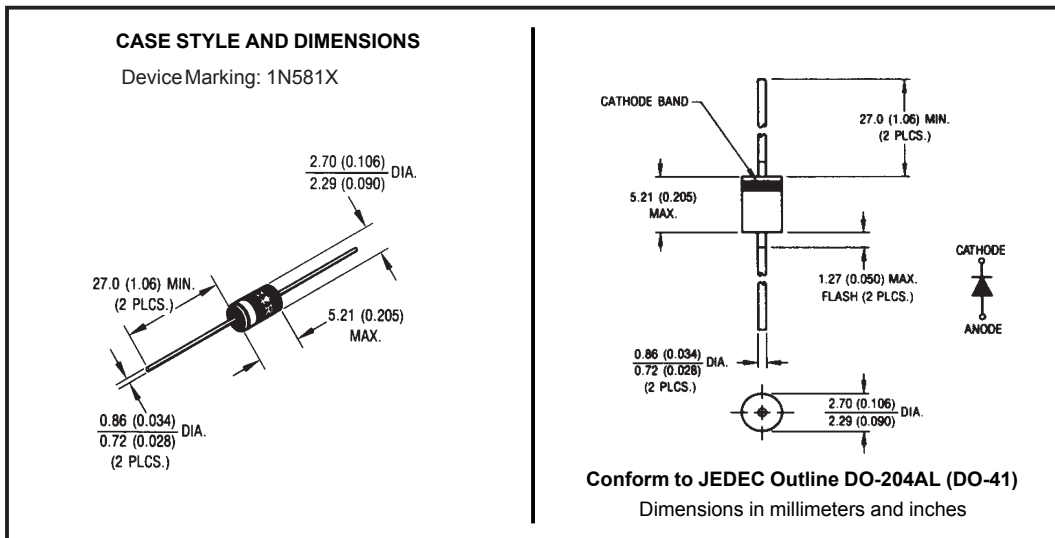

Voltage Ratings

Part number	1N5818	1N5819
V_R Max. DC Reverse Voltage (V)	30	40
V_{RWM} Max. Working Peak Reverse Voltage (V)		

Absolute Maximum Ratings

Parameters	Value	Units	Conditions
$I_{F(AV)}$ Max. Average Forward Current * See Fig. 4	1.0	A	50% duty cycle @ $T_L = 90^\circ\text{C}$, rectangular wave form
I_{FSM} Max. Peak One Cycle Non-Repetitive Surge Current * See Fig. 6	225	A	5 μs Sine or 3 μs Rect. pulse
	35		10ms Sine or 6ms Rect. pulse

Following any rated load condition and with rated V_{RWM} applied

Electrical Specifications

Parameters	1N5818	1N5819	Units	Conditions
V_{FM} Max. Forward Voltage Drop * See Fig. 1 (1)	0.55	0.6	V	@ 1A
	0.71	0.73	V	@ 2A
	0.875	0.9	V	@ 3A
	0.5	0.55	V	@ 1A
	0.61	0.63	V	@ 2A
	0.77	0.79	V	@ 3A
I_{RM} Max. Reverse Leakage Current * See Fig. 2 (1)	1.0		mA	$T_J = 25^\circ\text{C}$
	6.0		mA	$T_J = 100^\circ\text{C}$
	12		mA	$T_J = 125^\circ\text{C}$
C_T Max. Junction Capacitance	60		pF	$V_R = 5V_{DC}$ (test signal range 100 to 1Mhz) 25°C
L_S Typical Series Inductance	8.0		nH	Measured lead to lead 5mm from pack. body
dv/dt Max. Voltage Rate of Change (Rated V_R)	10000		V/ μs	

(1) Pulse Width < 300 μs , Duty Cycle < 2%

Thermal-Mechanical Specifications

Parameters	Value	Units	Conditions
T_J Max. Junction Temperature Range	-40 to 150	$^\circ\text{C}$	
T_{stg} Max. Storage Temperature Range	-40 to 150	$^\circ\text{C}$	
R_{thJL} Max. Thermal Resistance Junction to Lead (2)	80	$^\circ\text{C}/\text{W}$	DC operation (* See Fig. 4)
wt Approximate Weight	0.33(0.012)	g(oz.)	
Case Style	DO-204AL(DO-41)		

(2) Mounted 1 inch square PCB, thermal probe connected to lead 2mm from package

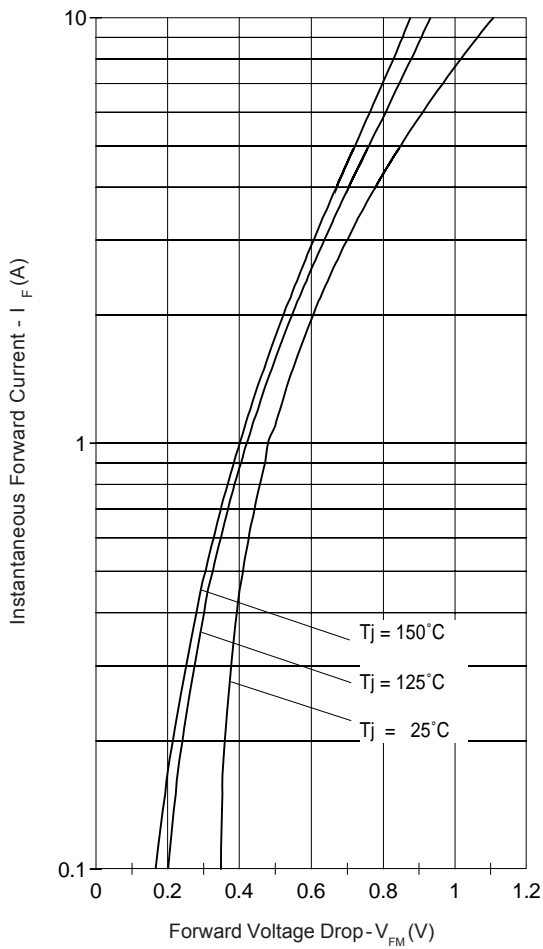

Fig. 1 - Typ. Forward Voltage Drop Characteristics

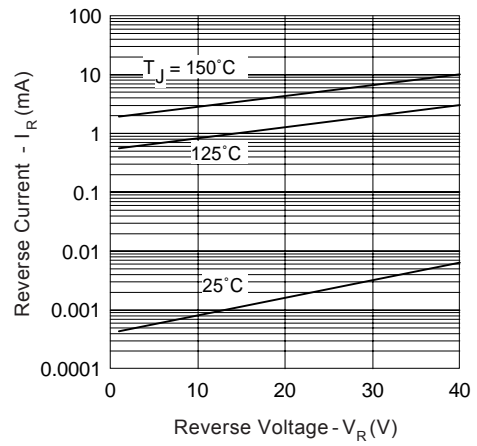

Fig. 2 - Typical Values Of Reverse Current Vs. Reverse Voltage

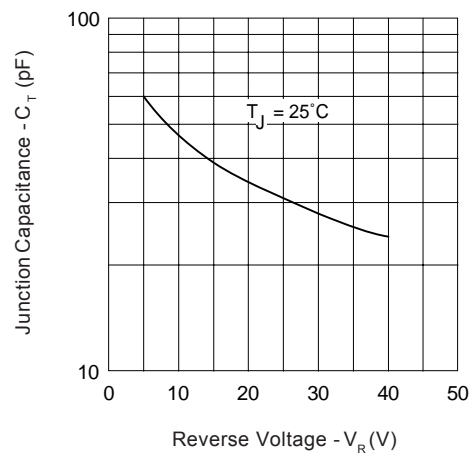

Fig. 3 - Typical Junction Capacitance Vs. Reverse Voltage

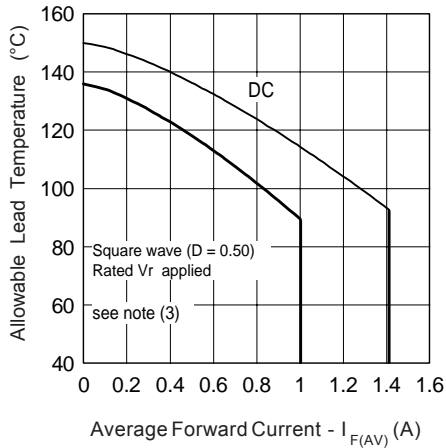

Fig. 4 - Typ. Allowable Lead Temperature Vs. Average Forward Current

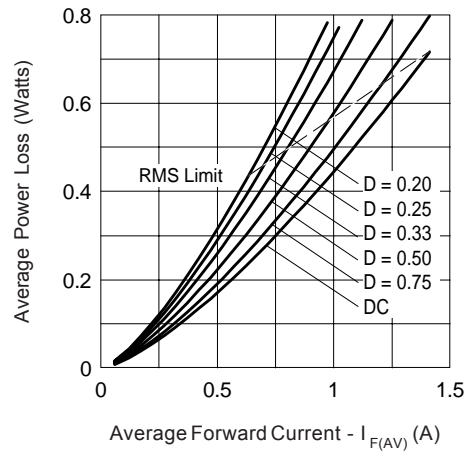

Fig. 5 - Forward Power Loss Characteristics

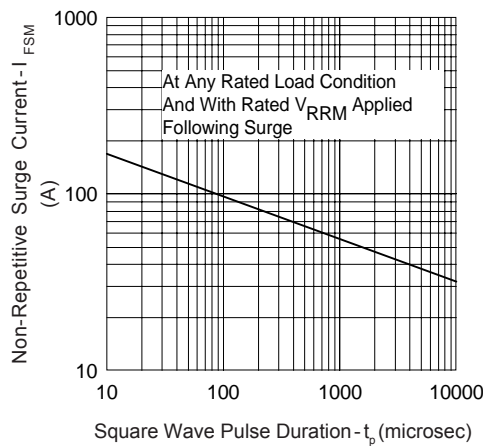
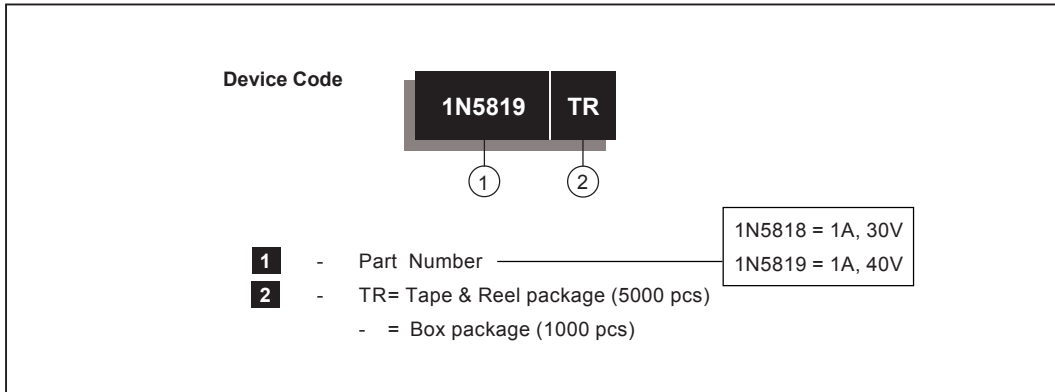

Fig. 6 - Typ. Non-Repetitive Surge Current

- (2) Formula used: $T_C = T_J - (Pd + Pd_{REV}) \times R_{thJC}$;
 $Pd = \text{Forward Power Loss} = I_{F(AV)} \times V_{FM} @ (I_{F(AV)} / D)$ (see Fig. 6);
 $Pd_{REV} = \text{Inverse Power Loss} = V_{R1} \times I_R (1 - D)$; $I_R @ V_{R1} = 80\% \text{ rated } V_R$

Ordering Information Table



Data and specifications subject to change without notice.
 This product has been designed and qualified for Industrial Level and Lead-Free.
 Qualification Standards can be found on IR's Web site.