

Features

- Glass passivated device
- Ideally Suited for Automatic Assembly
- Low Forward Voltage Drop, High Efficiency
- Surge Overload Rating to 2.5 A Peak
- Low Power Loss
- Ultra-Fast Recovery Time
- Plastic Case Material has UL Flammability
- Classification Rating 94V-0

Mechanical Data

- Case: SOD-123FL, Molded Plastic
- Terminals: Solder Plated, Solderable per MIL-STD-750, Method 2026
- Polarity: Cathode Band or Cathode Notch
- Marking: Type Number
- Weight: 0.01 grams (approx.)
- **Lead Free: For RoHS / Lead Free Version**

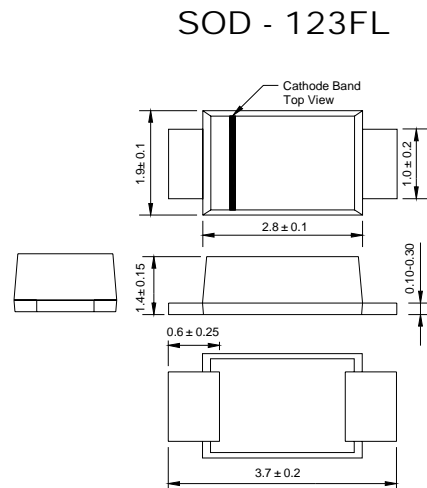

Maximum Ratings and Electrical Characteristics @T_A=25°C unless otherwise specified

Characteristic	Symbol	1N	1N	1N	1N	1N	1N	1N	UNITS
		4001W	4002W	4003W	4004W	4005W	4006W	4007W	
Device marking code		A1	A2	A3	A4	A5	A6	A7	
Peak Repetitive Reverse Voltage	V _{RRM}	50	100	200	400	600	800	1000	V
Working Peak Reverse Voltage	V _{RWM}								
DC Blocking Voltage	V _R								
RMS Reverse Voltage	V _{R(RMS)}	35	70	140	280	420	560	800	V
Average Rectified Output Current @T _L = 100°C	I _O	1.0							A
Non-Repetitive Peak Forward Surge Current 8.3ms Single half sine-wave superimposed on rated load (JEDEC Method)	I _{FSM}	25							A
Forward Voltage @I _F = 1.0A	V _{FM}	1.3							V
Peak Reverse Current @T _A = 25°C	I _{RM}	10							μA
At Rated DC Blocking Voltage @T _A = 100°C		500							
Typical Junction Capacitance (Note 2)	C _j	15							pF
Typical Thermal Resistance (Note 3)	R _{θJL}	30							°C/W
Operating and Storage Temperature Range	T _j , T _{STG}	-65 to +150							°C

Note: 1. Measured with I_F = 0.5A, I_R = 1.0A, I_{rr} = 0.25A. See figure 5.
 2. Measured at 1.0 MHz and applied reverse voltage of 4.0 V DC.
 3. Mounted on P.C. Board with 8.0mm² land area.

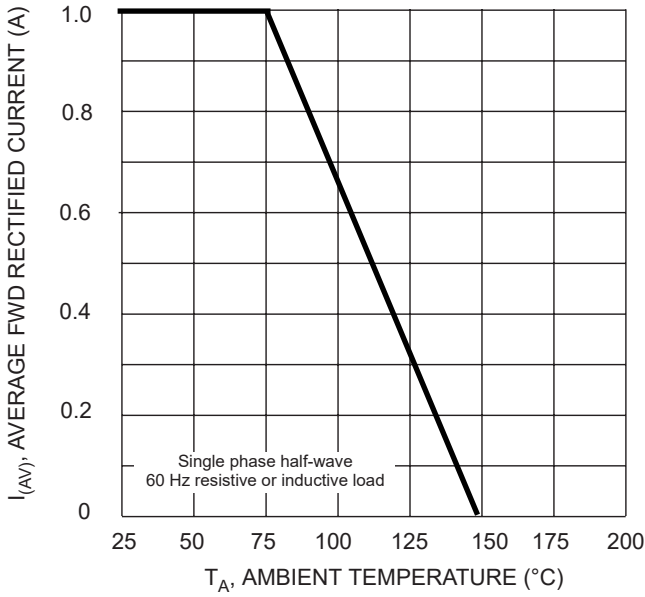

Fig. 1 Forward Derating Curve

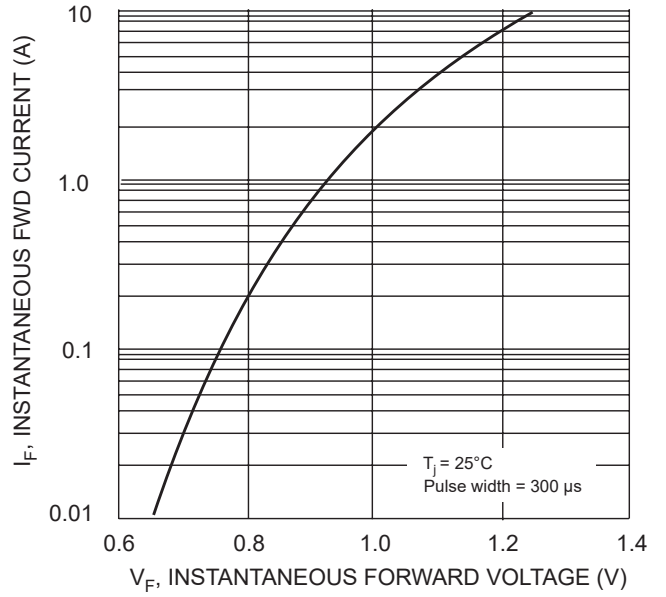

Fig. 2 Typical Forward Characteristics

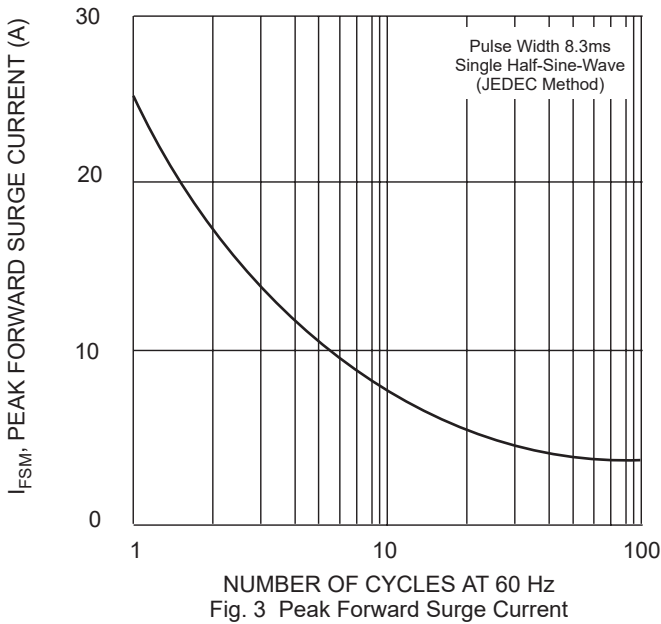

Fig. 3 Peak Forward Surge Current

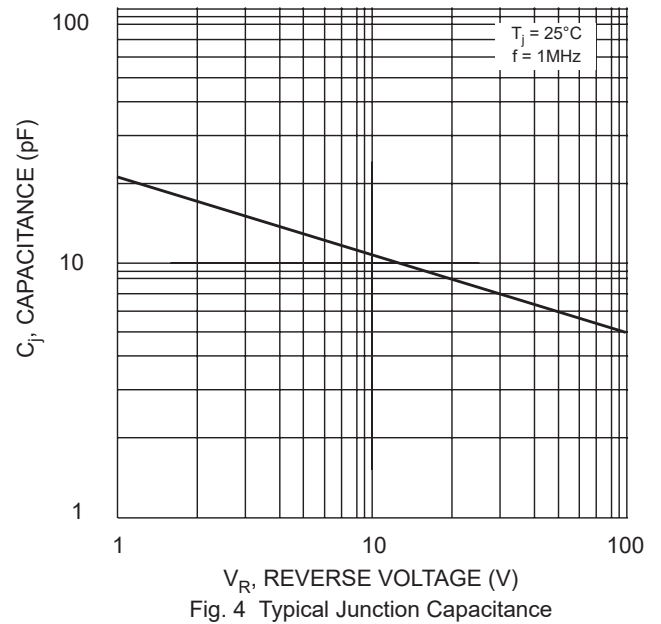
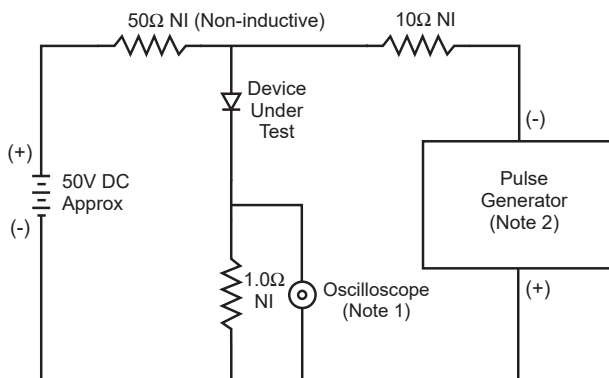
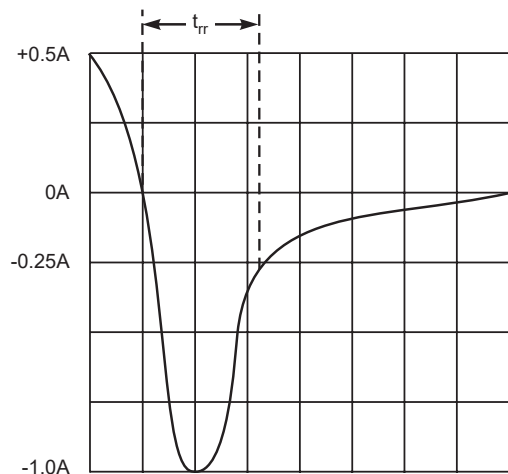

Fig. 4 Typical Junction Capacitance



- Notes:
1. Rise Time = 7.0ns max. Input Impedance = 1.0MΩ, 22pF.
 2. Rise Time = 10ns max. Input Impedance = 50Ω.



Set time base for 5/10ns/cm

Fig. 5 Reverse Recovery Time Characteristic and Test Circuit