

**PHASE CONTROL SCR**

**Description/Features**

The 16TTS.. **SAFEIR** series of silicon controlled rectifiers are specifically designed for medium power switching and phase control applications. The glass passivation technology used has reliable operation up to 125° C junction temperature.

Typical applications are in input rectification (soft start) and these products are designed to be used with International Rectifier input diodes, switches and output rectifiers which are available in identical package outlines.

	$V_T < 1.4V @ 10A$ $I_{TSM} = 200A$ $V_{RRM} = 800 \text{ to } 1600V$
---	---

**Output Current in Typical Applications**

Applications	Single-phase Bridge	Three-phase Bridge	Units
Capacitive input filter $T_A = 55^\circ C, T_J = 125^\circ C,$ common heatsink of $1^\circ C/W$	13.5	17	A

**Major Ratings and Characteristics**

Characteristics	16TTS..	Units
$I_{T(AV)}$ Sinusoidal waveform	10	A
$I_{RMS}$	16	A
$V_{RRM}/V_{DRM}$	upto 1600	V
$I_{TSM}$	200	A
$V_T @ 10A, T_J = 25^\circ C$	1.4	V
dv/dt	500	V/ $\mu s$
di/dt	150	A/ $\mu s$
$T_J$ range	-40 to 125	°C

**Package Outline**

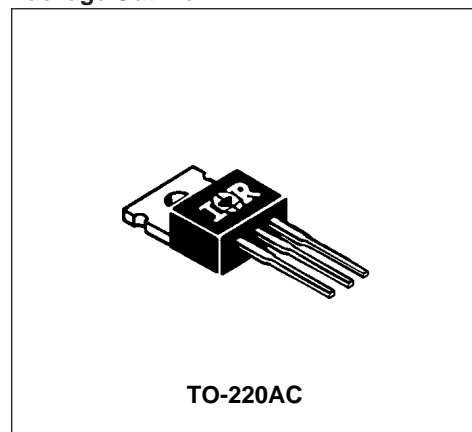

Also available in SMD-220 package (series 16TTS..S)

## Voltage Ratings

Part Number	$V_{RRM}$ , maximum peak reverse voltage V	$V_{DRM}$ , maximum peak direct voltage V	$I_{RRM}/I_{DRM}$ 125°C mA
16TTS08	800	800	10
16TTS12	1200	1200	
16TTS16	1600	1600	

## Absolute Maximum Ratings

Parameters	16TTS..	Units	Conditions		
$I_{T(AV)}$ Max. Average On-state Current	10	A	@ $T_C = 98^\circ\text{C}$ , 180° conduction half sine wave		
$I_{RMS}$ Max. RMS On-state Current	16				
$I_{TSM}$ Max. Peak One Cycle Non-Replicative Surge Current	170 200		10ms Sine pulse, rated $V_{RRM}$ applied 10ms Sine pulse, no voltage reapplied		
$I^2t$ Max. $I^2t$ for fusing	144 200	$A^2s$	10ms Sine pulse, rated $V_{RRM}$ applied 10ms Sine pulse, no voltage reapplied		
$I^2\sqrt{t}$ Max. $I^2\sqrt{t}$ for fusing	2000		$A^2\sqrt{s}$	t=0.1 to 10ms, no voltage reapplied	
$V_{TM}$ Max. On-state Voltage Drop	1.4	V	@ 10A, $T_J = 25^\circ\text{C}$		
$r_t$ On-state slope resistance	24.0	mΩ	$T_J = 125^\circ\text{C}$		
$V_{T(TO)}$ Threshold Voltage	1.1	V			
$I_{RM}/I_{DM}$ Max. Reverse and Direct Leakage Current	0.5	mA	$T_J = 25^\circ\text{C}$	$V_R = \text{rated } V_{RRM} / V_{DRM}$	
	10		$T_J = 125^\circ\text{C}$		
$I_H$ Holding Current	Typ.	Max.	Anode Supply = 6V, Resistive load, Initial $I_T = 1A$ 16TTS08, 16TTS12 16TTS16		
	–	100			mA
	100	150			
$I_L$ Max. Latching Current	200	mA	Anode Supply = 6V, Resistive load		
dv/dt Max. Rate of Rise of off-state Voltage	500	V/μs			
di/dt Max. Rate of Rise of turned-on Current	150	A/μs			

### Triggering

Parameters	16TTS..	Units	Conditions
$P_{GM}$ Max. peak Gate Power	8.0	W	
$P_{G(AV)}$ Max. average Gate Power	2.0		
+ $I_{GM}$ Max. peak positive Gate Current	1.5	A	
- $V_{GM}$ Max. peak negative Gate Voltage	10	V	
$I_{GT}$ Max. required DC Gate Current to trigger	90	mA	Anode supply = 6V, resistive load, $T_J = -65^\circ\text{C}$
	60		Anode supply = 6V, resistive load, $T_J = 25^\circ\text{C}$
	35		Anode supply = 6V, resistive load, $T_J = 125^\circ\text{C}$
$V_{GT}$ Max. required DC Gate Voltage to trigger	3.0	V	Anode supply = 6V, resistive load, $T_J = -65^\circ\text{C}$
	2.0		Anode supply = 6V, resistive load, $T_J = 25^\circ\text{C}$
	1.0		Anode supply = 6V, resistive load, $T_J = 125^\circ\text{C}$
$V_{GD}$ Max. DC Gate Voltage not to trigger	0.2		$T_J = 125^\circ\text{C}$ , $V_{DRM} = \text{rated value}$
$I_{GD}$ Max. DC Gate Current not to trigger	2.0	mA	$T_J = 125^\circ\text{C}$ , $V_{DRM} = \text{rated value}$

### Switching

Parameters	16TTS..	Units	Conditions
$t_{gt}$ Typical turn-on time	0.9	$\mu\text{s}$	$T_J = 25^\circ\text{C}$
$t_{rr}$ Typical reverse recovery time	4		$T_J = 125^\circ\text{C}$
$t_q$ Typical turn-off time	110		

### Thermal-Mechanical Specifications

Parameters	16TTS..	Units	Conditions
$T_J$ Max. Junction Temperature Range	-40 to 125	$^\circ\text{C}$	
$T_{stg}$ Max. Storage Temperature Range	-40 to 125		
$R_{thJC}$ Max. Thermal Resistance Junction to Case	1.3	$^\circ\text{C/W}$	DC operation
$R_{thJA}$ Max. Thermal Resistance Junction to Ambient	62		
$R_{thCS}$ Typ. Thermal Resistance Case to Heatsink	0.5		Mounting surface, smooth and greased
wt Approximate Weight	2(0.07)	g(oz.)	
T Mounting Torque	Min.	6(5)	Kg-cm (lbf-in)
	Max.	12(10)	
Case Style	TO-220AC		

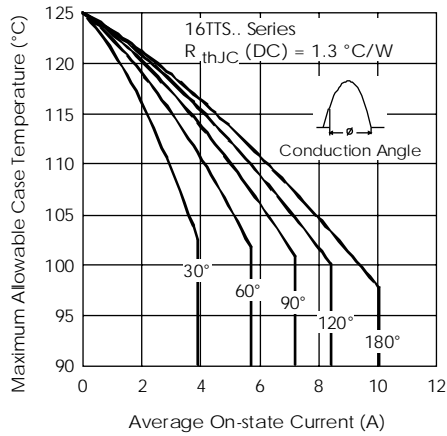

Fig. 1 - Current Rating Characteristics

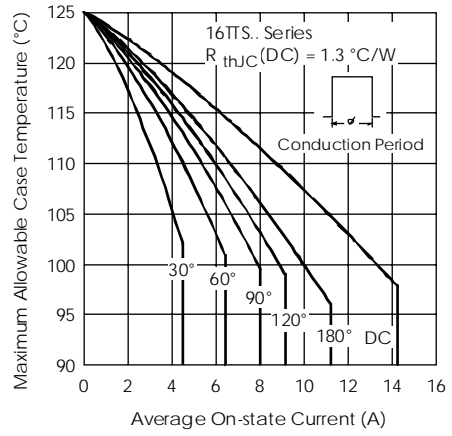

Fig. 2 - Current Rating Characteristics

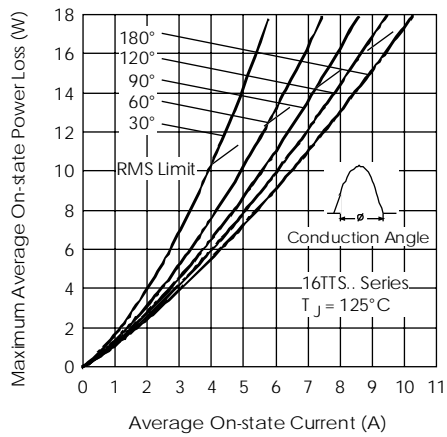

Fig. 3 - On-state Power Loss Characteristics

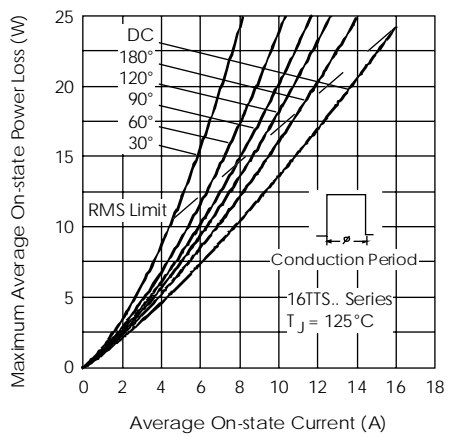

Fig. 4 - On-state Power Loss Characteristics

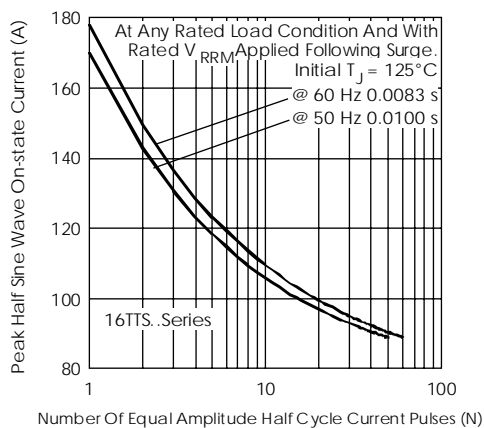

Fig. 6 - Maximum Non-Repetitive Surge Current

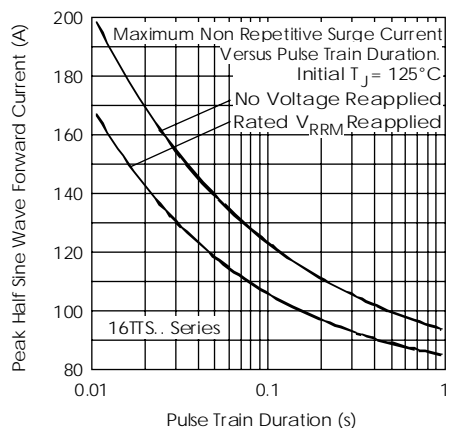

Fig. 7 - Maximum Non-Repetitive Surge Current

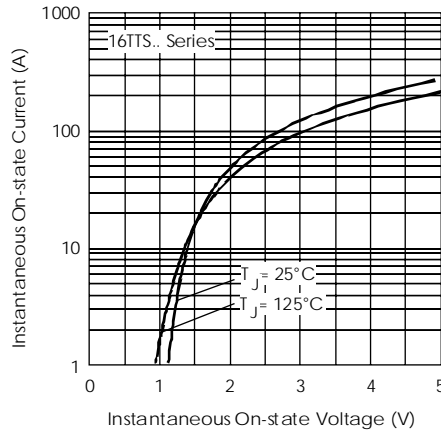

Fig. 7 - On-state Voltage Drop Characteristics

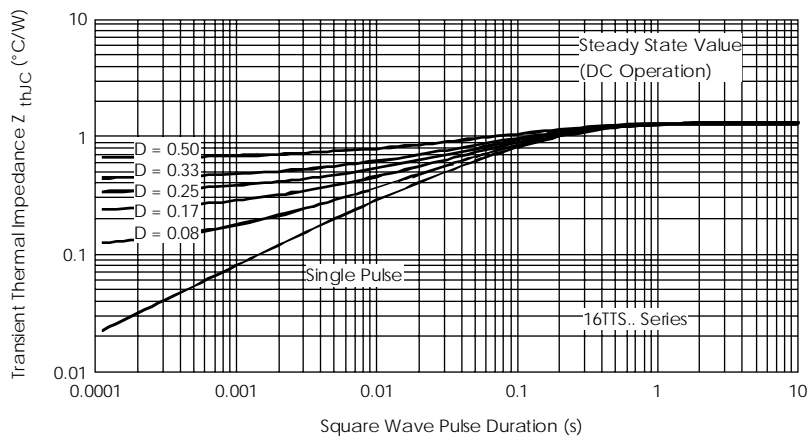

Fig. 8 - Thermal Impedance  $Z_{thJC}$  Characteristics

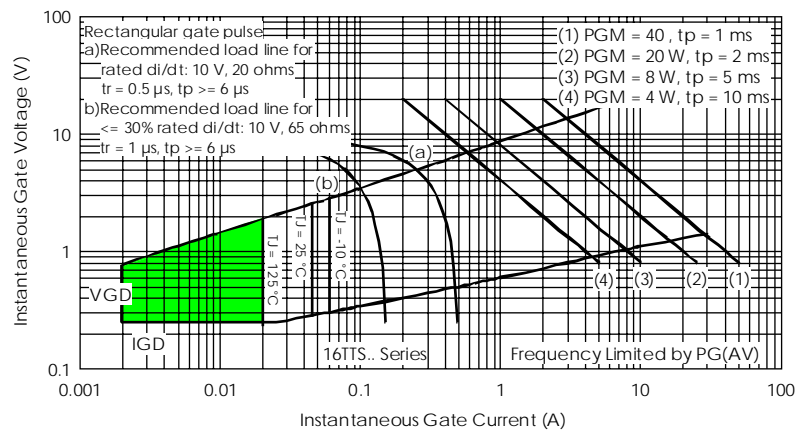
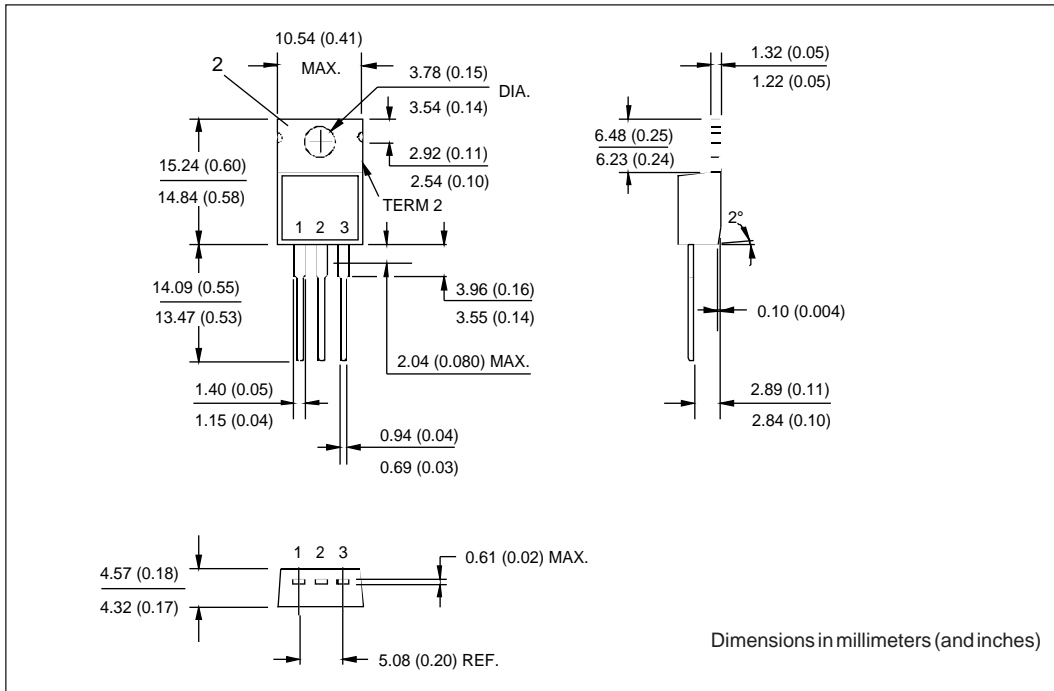
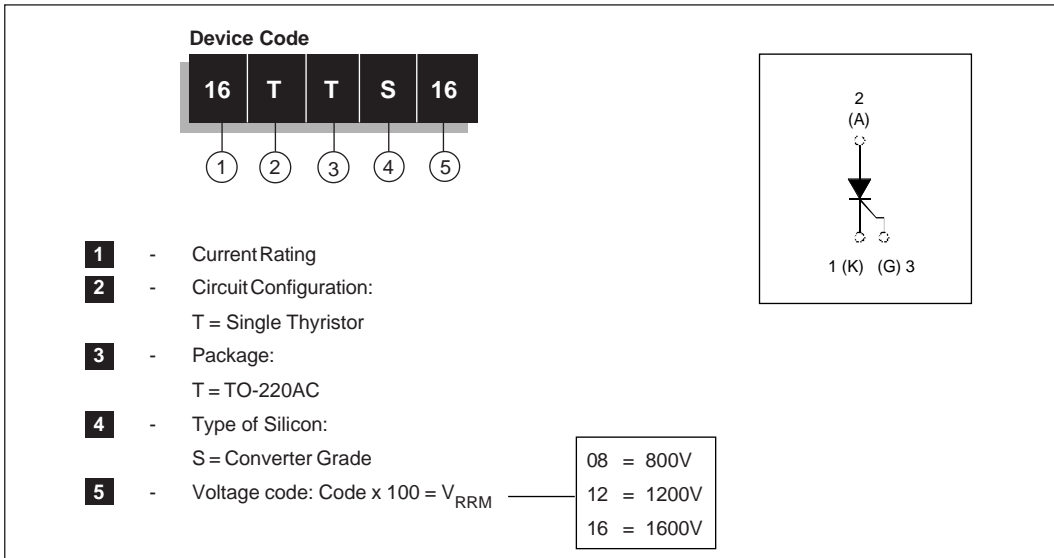

Fig. 9 - Gate Characteristics

Outline Table



Ordering Information Table



International  
**IOR** Rectifier

**WORLD HEADQUARTERS:** 233 Kansas St., El Segundo, California 90245 U.S.A. Tel: (310) 322 3331. Fax: (310) 322 3332.  
**EUROPEAN HEADQUARTERS:** Hurst Green, Oxted, Surrey RH8 9BB, U.K. Tel: ++ 44 1883 732020. Fax: ++ 44 1883 733408.  
**IR CANADA:** 15 Lincoln Court, Brampton, Markham, Ontario L6T3Z2. Tel: (905) 453 2200. Fax: (905) 475 8801.  
**IR GERMANY:** Saalburgstrasse 157, 61350 Bad Homburg. Tel: ++ 49 6172 96590. Fax: ++ 49 6172 965933.  
**IR ITALY:** Via Liguria 49, 10071 Borgaro, Torino. Tel: ++ 39 11 4510111. Fax: ++ 39 11 4510220.  
**IR FAR EAST:** K&H Bldg., 2F, 30-4 Nishi-Ikebukuro 3-Chome, Toshima-Ku, Tokyo, Japan 171. Tel: 81 3 3983 0086.  
**IR SOUTHEAST ASIA:** 1 Kim Seng Promenade, Great World City West Tower, 13-11, Singapore 237994. Tel: ++ 65 838 4630.  
**IR TAIWAN:** 16 Fl. Suite D.207, Sec. 2, Tun Haw South Road, Taipei, 10673, Taiwan. Tel: 886 2 2377 9936.

<http://www.irf.com>

Fax-On-Demand: +44 1883 733420

Data and specifications subject to change without notice.