



FEATURES

- RoHS compliant
- Radial format
- -40°C to 85°C operating temperature
- Up to 13A ldc
- 10µH to 22mH
- Low DC resistance
- Fully tinned leads
- PCB mounting hole
- Low temperature dependence
- Backward compatible with Sn/Pb soldering systems
- Custom parts available

DESCRIPTION

The 1400 Series is suitable for many power supply and other general purpose filtering applications. The use of a non-magnetic screw will ensure mechanical stability.

SELECTION GUIDE

Order Code	Inductance, (1kHz, 0.1V _{AC})	DC Current ¹	DC Resistance	Q at f kHz		SRF	Mechanical Dimensions					Footprint	
	±10%	Max.	Max.	Nom.		Nom.	a	b	c	d	Øe	f	Øg
	µH	A	Ω	Q	f	MHz	mm					mm	
1410313C	10	13	0.007	54	50	20.7	27.0	24.4	14.0	1.30	4.5	23.9	2.6
1415312C	15	12	0.009	42	50	12.7	27.0	24.4	14.0	1.30	4.5	23.9	2.6
1422311C	22	11	0.011	64	100	9.3	27.0	24.4	14.0	1.30	4.5	23.9	2.6
1433393C	33	9.3	0.015	27	50	9.1	27.0	24.4	14.0	1.30	4.5	23.9	2.6
1447383C	47	8.3	0.019	40	100	6.0	27.0	24.4	18.5	1.30	4.5	23.9	2.6
1447385C	47	8.5	0.021	33	100	6.7	26.8	24.4	14.0	1.20	4.5	23.8	2.4
1468362C	68	6.2	0.032	32	100	5.3	26.5	24.4	14.0	1.08	4.5	23.7	2.1
1468373C	68	7.3	0.022	45	100	5.3	27.0	24.4	18.5	1.30	4.5	23.9	2.6
1410454C	100	5.4	0.042	24	100	4.6	26.4	24.4	14.0	1.02	4.5	23.6	2.0
1410460C	100	6.0	0.033	37	100	3.9	26.8	24.4	18.5	1.20	4.5	23.8	2.4
1410478C	100	7.8	0.040	34	50	3.3	32.4	29.8	21.8	1.30	5.1	29.3	2.6
1415440C	150	4.0	0.069	24	50	3.4	26.2	24.4	14.0	0.90	4.5	23.5	1.8
1415449C	150	4.9	0.051	34	50	2.9	26.4	24.4	18.5	1.02	4.5	23.6	2.0
1415465C	150	6.5	0.042	46	100	2.4	32.2	29.8	21.8	1.20	5.1	29.2	2.4
1422435C	220	3.5	0.096	22	50	2.8	26.1	24.4	14.0	0.85	4.5	23.5	1.7
1422441C	220	4.1	0.073	33	100	2.3	26.3	24.4	18.5	0.97	4.5	23.6	1.9
1422455C	220	5.5	0.062	30	50	2.2	32.1	29.8	21.8	1.14	5.1	29.1	2.2
1430430C	300	3.0	0.140	26	50	2.6	25.9	24.4	14.0	0.75	4.5	23.4	1.5
1430433C	300	3.3	0.100	37	50	2.2	26.2	24.4	18.5	0.90	4.5	23.5	1.8
1430450C	300	5.0	0.080	28	50	1.7	31.8	29.8	21.8	1.02	5.1	29.0	2.0
1433428C	330	2.8	0.150	22	50	2.5	25.9	24.4	14.0	0.76	4.5	23.4	1.5
1433433C	330	3.3	0.107	29	50	2.0	26.2	24.4	18.5	0.90	4.5	23.5	1.8
1433445C	330	4.5	0.091	25	50	1.6	31.8	29.8	21.8	1.02	5.1	29.0	2.0
1447423C	470	2.3	0.222	34	50	2.0	25.7	24.4	14.0	0.67	4.5	23.3	1.3
1447427C	470	2.7	0.149	25	50	1.6	26.1	24.4	18.5	0.85	4.5	23.5	1.7
1447440C	470	4.0	0.125	24	50	1.4	31.7	29.8	21.8	0.97	5.1	29.0	1.9
1468420C	680	2.0	0.276	23	50	1.6	25.7	24.4	14.0	0.67	4.5	23.3	1.3
1468422C	680	2.2	0.226	28	50	1.3	25.9	24.4	18.5	0.75	4.5	23.4	1.5
1468431C	680	3.1	0.173	60	10	1.0	31.6	29.8	21.8	0.90	5.1	28.9	1.8
1410516C	1.0mH	1.6	0.419	30	50	1.4	25.6	24.4	14.0	0.60	4.5	23.2	1.2
1410517C	1.0mH	1.7	0.336	35	50	1.2	25.7	24.4	18.5	0.67	4.5	23.3	1.3
1410524C	1.0mH	2.4	0.277	33	50	1.0	31.4	29.8	21.8	0.79	5.1	28.8	1.5
1415513C	1.5mH	1.3	0.630	34	50	1.0	25.5	24.4	14.0	0.54	4.5	23.1	1.0
1415514C	1.5mH	1.4	0.518	47	50	0.8	25.6	24.4	18.5	0.60	4.5	23.2	1.2
1415517C	1.5mH	1.7	0.374	28	50	0.7	31.3	29.8	21.8	0.75	5.1	28.8	1.5
1422509C	2.2mH	0.9	0.916	43	50	0.9	25.3	24.4	14.0	0.48	4.5	23.1	0.9
1422512C	2.2mH	1.2	0.649	33	50	0.7	25.6	24.4	18.5	0.60	4.5	23.2	1.2
1422514C	2.2mH	1.4	0.622	33	50	0.6	31.1	29.8	21.8	0.67	5.1	28.7	1.3
1433507C	3.3mH	0.7	1.428	45	50	0.8	25.2	24.4	14.0	0.43	4.5	23.0	0.8
1433510C	3.3mH	1.0	1.992	20	50	0.7	25.5	24.4	18.5	0.54	4.5	23.1	1.0
1433512C	3.3mH	1.2	0.861	20	50	0.5	31.0	29.8	21.8	0.60	5.1	28.6	1.2
1447506C	4.7mH	0.6	2.200	60	50	0.6	25.2	24.4	14.0	0.39	4.5	23.0	0.7
1447508C	4.7mH	0.8	1.436	65	50	0.5	25.3	24.4	18.5	0.48	4.5	23.1	0.9
1447509C	4.7mH	0.9	1.250	57	10	0.5	30.9	29.8	21.8	0.54	5.1	28.5	1.0
1468505C	6.8mH	0.5	2.810	50	50	0.5	25.2	24.4	14.0	0.39	4.5	23.0	0.7
1468507C	6.8mH	0.7	2.214	47	50	0.4	25.2	24.4	18.5	0.43	4.5	23.0	0.8
1468508C	6.8mH	0.8	1.884	30	50	0.4	30.7	29.8	21.8	0.48	5.1	28.5	0.9
1410604C	10mH	0.4	4.340	51	50	0.4	25.1	24.4	14.0	0.34	4.5	22.9	0.6
1410605C	10mH	0.5	3.394	48	50	0.3	25.2	24.4	18.5	0.39	4.5	23.0	0.7
1410606C	10mH	0.6	2.294	48	50	0.2	30.9	29.8	21.8	0.54	5.1	28.5	1.0
1415604C	15mH	0.4	4.912	61	10	0.2	25.1	24.4	18.5	0.34	4.5	22.9	0.6
1415605C	15mH	0.5	3.740	55	10	0.2	30.6	29.8	21.8	0.43	5.1	28.4	0.8
1422604C	22mH	0.4	6.962	30	50	0.2	30.5	29.8	21.8	0.34	5.1	28.3	0.6

1 Maximum DC current occurs when either the inductance falls to 60% of its nominal value or when its temperature rise reaches 50°C, whichever is sooner.



SOLDERING INFORMATION²

Peak wave solder temperature	300°C for 10 seconds
Pin finish	Pure tin dip

TYPICAL CORE/WIRE CHARACTERISTICS

Inductance Temperature Coefficient	Resistance Temperature Coefficient	Curie Temperature (T _c)	Saturation Flux (B _{SAT})
215ppm	3900ppm	130°C	240mT

ABSOLUTE MAXIMUM RATINGS

Operating free air temperature range	-40°C to 85°C
Storage temperature range	-55°C to 125°C

All specifications typical at T_a=25°C

² For further information, please visit www.murata-ps.com/rohs

PACKAGE SPECIFICATIONS

MECHANICAL DIMENSIONS

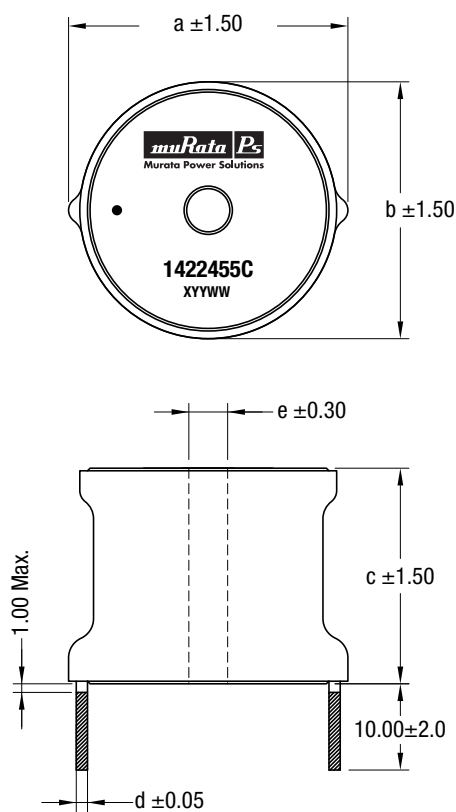

All dimensions in mm.
Package weight: 30-65g Typ.
Marking indicates start of winding.

RECOMMENDED FOOTPRINT DETAILS

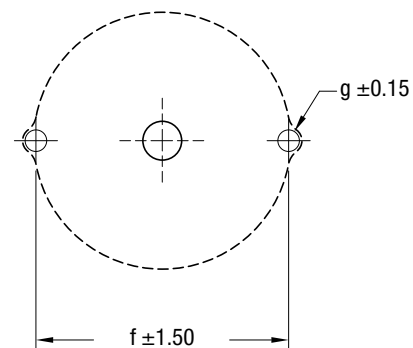

All dimensions in mm

Murata Power Solutions, Inc.

11 Cabot Boulevard, Mansfield, MA 02048-1151 U.S.A.

Tel: (508) 339-3000 (800) 233-2765 Fax: (508) 339-6356

www.murata-ps.com email: sales@murata-ps.com ISO 9001 REGISTERED

Murata Power Solutions, Inc. makes no representation that the use of its products in the circuits described herein, or the use of other technical information contained herein, will not infringe upon existing or future patent rights. The descriptions contained herein do not imply the granting of licenses to make, use, or sell equipment constructed in accordance therewith. Specifications are subject to change without notice.
© 2007 Murata Power Solutions, Inc.

USA: Mansfield (MA), Tel: (800) 233 2765, email: sales@murata-ps.com

Canada: Toronto, Tel: (866) 740 1232, email: toronto@murata-ps.com

UK: Milton Keynes, Tel: +44 (0)1908 615232, email: mk@murata-ps.com

France: Montigny Le Bretonneux, Tel: +33 (0)1 34 60 01 01, email: france@murata-ps.com

Germany: München, Tel: +49 (0)89-544334-0, email: ped.munich@murata-ps.com

Japan: Tokyo, Tel: 3-3779-1031, email: sales_tokyo@murata-ps.com
Osaka, Tel: 6-6354-2025, email: sales_osaka@murata-ps.com

Website: www.murata-ps.jp

China: Shanghai, Tel: +86 215 027 3678, email: shanghai@murata-ps.com
Guangzhou, Tel: +86 208 221 8066, email: guangzhou@murata-ps.com