



High Reliability, Military D Subminiature, & Non-Magnetic/No-Outgas

Solder Cup



(See page 333)

Crimp



(See page 334-335)

Printed Circuit



(See page 336-338)

Performance and Material Specifications

MATERIALS AND FINISHES

	Standard		Military	
	Material	Finish	Material	Finish
Shell	Steel per ASTM A-620	Yellow chromate over cadmium QQ-P-416 Type II Class 2	Steel per ASTM A-620	Yellow chromate over cadmium QQ-P-416 Type II Class 2
Insulator	Diallyl phthalate glass-filled per MIL-M-14, type SDG-F, color green		Diallyl phthalate glass-filled per MIL-M-14, type SDG-F, color green	
Contact	Copper alloy	Gold over nickel	Copper Alloy Crimp Socket has stainless steel hood passivated.	Gold 50 microinches minimum thickness per MIL-G-45204 Type II Grade C Class 1 over copper per MIL-C-14550 Hood: Passivated
Float Mount Hardware	Stainless steel	Passivate per QQ-P-35	Stainless steel	Passivate per QQ-P-35

PERFORMANCE SPECIFICATIONS

Wire Accommodation (AWG)	Solder - #20 Max. Crimp - #18- #30 Max.
Current Rating	#20; 5 Amp
Temperature Rating	-65°C to +150°C
Contact Resistance	55 @ 7.5 Amp
After Salt Spray, Millivolt Max.	test current

See pages 339 and 340 for complete M24308 cross reference.

DIELECTRIC WITHSTANDING VOLTAGE

	90° and Straight (Solder/Crimp)			
	Altitude (feet/m)			
	Sea Level	20,000/6,096	50,000/15,240	70,000/21,336
Average Flashover	1700/1500	1000/1000	650/500	500/500
Test	1250/1000	750/650	475/325	375/325

All voltage figures are rms AC 60 rms cps, measured at approximately +25°C, 50% rh. For additional performance specifications refer to MIL-C-24308 Test Extracts on page 385.

Non-Magnetic/No-Outgas Options

Suffix Code	Residual Magnetism	Shell Material (Finish)	Desired Results
NMB	200 Gamma Residual Magnetism Insulator. (Diallyl Phtalate per MIL-M-14 type SDG-F, color white.)	Bras Shells Per QQ-B-613 (Yellow Chromate over Cadmium per QQ-P-416, Type II, Class 2.)	Non-Magnetic No-Outgas
NMB-K52	200 Gamma Residual Magnetism Insulator. (Diallyl Phtalate per MIL-M-14 type SDG-F, color white.)	Brass Shells Per QQ-B-613 (Gold over copper per MIL-G-45204, Type II, Grade C, Class 1 over copper per MIL-C-14550.)	Non-Magnetic No-Outgas

Note: Look for the **NM** symbol for orderign information.

Contact Arrangements

Face View Pin Insert

Shell Size
Contact Arrangement
Contact Size

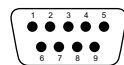

E

9

#20

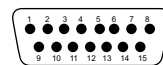

A

15

#20

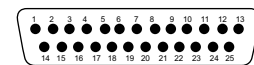

B

25

#20

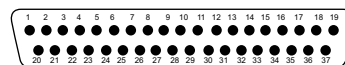

C

37

#20

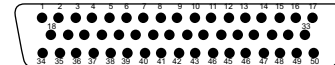

D

50

#20

Shell Size
Contact Arrangement
Contact Size

How to Order High Rel-Solder Cup Connectors (contacts are non-removable)



Mounting Options Available:

- 4-40 Clinch Nut - Add "E" to Part Number After "M"
- 4-40 Flood Mount - Add "Y" to Part Number After "M"
- (Can be used in front or rear panel mount applications)

Example: DBME25S DEMY9P
DBMME25S DEMMY9P

Performance Specifications - Page 332.

Receptacles (Includes Socket Contacts) With .120" Through-Mounting Holes

Number of Contacts (Shell Size)	Standard	Military Version	M24308 Cross Reference
9 (E)	DEM9S	DEMM9S	M24308/1-1
15 (A)	DAM15S	DAMM15S	M24308/1-2
25 (B)	DBM25S	DBMM25S	M24308/1-3
37 (C)	DCM37S	DCMM37S	M24308/1-4
50 (D)	DDM50S	DDMM50S	M24308/1-5

Plugs (Includes Pin Contacts)* With .120" Through-Mounting Holes

Number of Contacts (Shell Size)	Standard	Military Version	M24308 Cross Reference
9 (E)	DEM9P	DEMM9P	M24308/3-1
15 (A)	DAM15P	DAMM15P	M24308/3-2
25 (B)	DBM25P	DBMM25P	M24308/3-3
37 (C)	DCM37P	DCMM37P	M24308/3-4
50 (D)	DDM50P	DDMM50P	M24308/3-5

NM Non-Magnetic/No Outgas-Add desired suffix code with desired option to end of part number.

Example: DEMA9PSNMB
DEMA9PSNMB-K52

Dimensions - High Rel Solder Cup Connectors

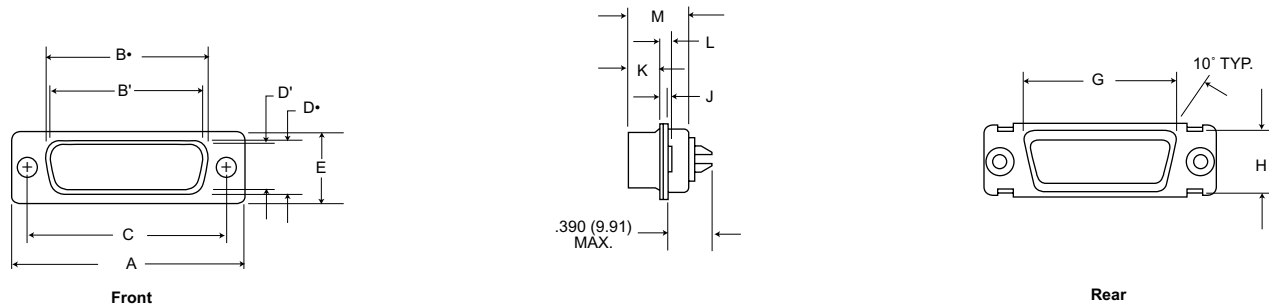

Part Number by Shell Size	A	B+	B'	C	D+	D'	E	G	H	J	K	L	M
DEM-9P	1.213 (30.81)	-	.666 (16.91)	.984 (24.99)	-	.329 (8.36)	.494 (12.55)	.759 (19.28)	.422 (10.72)	.030 (0.76)	.235 (5.94)	.048 (1.22)	.422 (10.72)
DEM-9S	1.213 (30.81)	.643 (16.33)	-	.984 (24.99)	.311 (7.90)	-	.494 (12.55)	.759 (19.28)	.422 (10.72)	.030 (0.76)	.243 (6.17)	.048 (1.22)	.429 (10.90)
DAM-15P	1.541 (39.14)	-	.994 (25.24)	1.312 (33.32)	-	.329 (8.36)	.494 (12.55)	1.083 (27.51)	.422 (10.72)	.030 (0.76)	.235 (5.97)	.048 (1.22)	.422 (10.72)
DAM-15S	1.541 (39.14)	.971 (24.66)	-	1.312 (33.32)	.311 (7.90)	-	.494 (12.55)	1.083 (27.51)	.422 (10.72)	.030 (0.76)	.243 (6.17)	.048 (1.22)	.429 (10.90)
DBM-25P	2.088 (53.03)	-	1.534 (38.96)	1.852 (47.04)	-	.329 (8.36)	.494 (12.55)	1.625 (41.27)	.422 (10.72)	.039 (0.99)	.230 (5.84)	.060 (1.52)	.426 (10.82)
DBM-25S	2.088 (53.03)	1.511 (38.38)	-	1.852 (47.04)	.311 (7.90)	-	.494 (12.55)	1.625 (41.27)	.422 (10.72)	.030 (0.76)	.243 (6.17)	.048 (1.22)	.429 (10.90)
DCM-37P	2.729 (69.31)	-	2.182 (55.42)	2.500 (63.50)	-	.329 (8.36)	.494 (12.55)	2.272 (57.71)	.422 (10.72)	.039 (0.99)	.230 (5.84)	.060 (1.52)	.426 (10.82)
DCM-37S	2.729 (69.31)	2.159 (54.84)	-	2.500 (63.50)	.311 (7.90)	-	.494 (12.55)	2.272 (57.71)	.422 (10.72)	.030 (0.76)	.243 (6.17)	.048 (1.22)	.429 (10.90)
DDM-50P	2.635 (66.92)	-	2.079 (52.81)	2.406 (61.11)	-	.441 (11.20)	.605 (15.37)	2.178 (55.32)	.534 (13.56)	.039 (0.99)	.230 (5.84)	.060 (1.52)	.426 (10.82)
DDM-50S	2.635 (66.92)	2.064 (52.43)	-	2.406 (61.11)	.423 (10.74)	-	.605 (15.37)	2.178 (55.32)	.534 (13.56)	.030 (0.76)	.243 (6.17)	.048 (1.22)	.429 (10.90)

*Dimensions B, D, G, and H are measured as outside dimensions at the bottom of the draw.
NOTE: B+ and D+ are the D.D. dims for socket side B' and D' are the I. D. dims. for pin side

Mounting Option Dimensions - Crimp Components

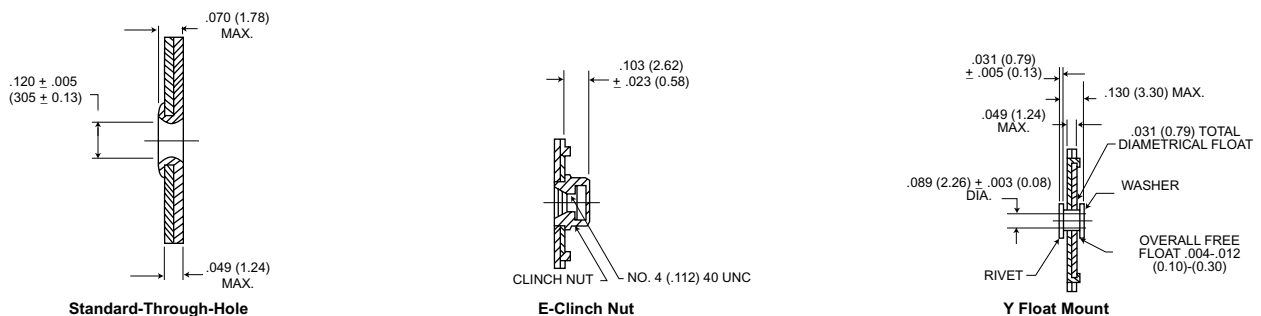

It is recommended that only one assembly, either pin or socket, be float mounted.

Dimensions are shown in inches (millimeters).
Dimensions subject to change.

How to Order - Crimp Connectors (contacts are removable)



Receptacles (Includes Socket Contacts) With .120" Through-Mounting Holes

Number of Contacts (Shell Size)	Standard	Military Version	M24308 Cross Reference
9 (E)	DEMA9S	DEMAM9S	M24308/2-1
15 (A)	DAMA15S	DAMAM15S	M24308/2-2
25 (B)	DBMA25S	DBMAM25S	M24308/2-3
37 (C)	DCMA37S	DCMAM37S	M24308/2-4
50 (D)	DDMA50S	DDMAM50S	M24308/2-5

Plugs (Includes Pin Contacts)* With .120" Through-Mounting Holes

Number of Contacts (Shell Size)	Standard	Military Version	M24308 Cross Reference
9 (E)	DEMA9P	DEMAM9P	M24308/4-1
15 (A)	DAMA15P	DAMAM15P	M24308/4-2
25 (B)	DBMA25P	DBMAM25P	M24308/4-3
37 (C)	DCMA37P	DCMAM37P	M24308/4-4
50 (D)	DDMA50P	DDMAM50P	M24308/4-5

To receive these connectors without contacts, add "F0" to end of part number.

Example: DBMA25SF0, DBMAM25SF0.

NM Non-Magnetic/No Outgas-Add desired suffix code with desired option to end of part number.

Example: DEMA9PSNMB
DEMA9PSNMB-K52

Crimp Connectors without contacts, add F0 to end of the part number and change K52 to K47.

Assembly Instructions - Page 363.

Performance Specifications - Page 332.

Mounting Options Available:

- 4-40 Clinch Nut - Add "E" to Part Number After "M" or "A"
 - 4-40 Flood Mount - Add "Y" to Part Number After "M" or "A"
- (Can be used in front or rear panel mount applications)

Example: DBMAE25S
DBMAM25S
DEMAY9P
DBMAMY9P

Dimensions - Crimp Connectors

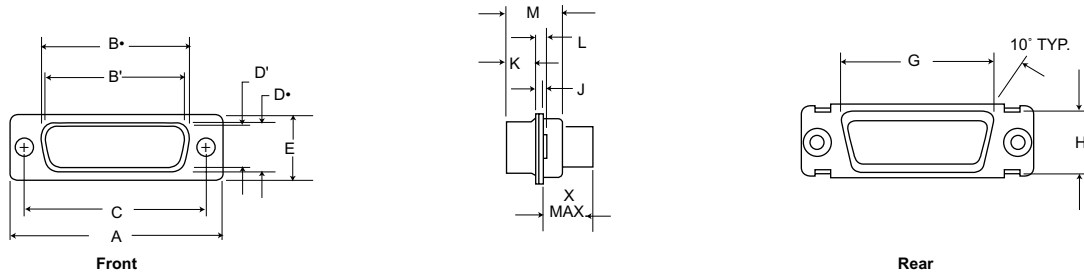

Part Number by Shell Size	A	B	B'	C	D	D'	E	G	H	J	K	L	M	X Max.
DEMA-9P	1.213 (30.81)	-	.666 (16.91)	.984 (24.99)	-	.329 (8.36)	.494 (12.55)	.759 (19.28)	.422 (10.72)	.030 (0.76)	.235 (5.97)	.048 (1.22)	.422 (10.72)	.345 (8.76)
DEMA-9S	1.213 (30.81)	.643 (16.33)	-	.984 (24.99)	.311 (7.90)	-	.494 (12.55)	.759 (19.28)	.422 (10.72)	.030 (0.76)	.243 (6.17)	.048 (1.22)	.429 (10.90)	.345 (8.76)
DAMA-15P	1.541 (39.14)	-	.994 (25.24)	1.312 (33.32)	-	.329 (8.36)	.494 (12.55)	1.083 (27.51)	.422 (10.72)	.030 (0.76)	.235 (5.97)	.048 (1.22)	.422 (10.72)	.345 (8.76)
DAMA-15S	1.541 (39.14)	.971 (24.66)	-	1.312 (33.32)	.311 (7.90)	-	.494 (12.55)	1.083 (27.51)	.422 (10.72)	.030 (0.76)	.243 (6.17)	.048 (1.22)	.429 (10.90)	.345 (8.76)
DBMA-25P	2.088 (53.03)	-	1.534 (38.96)	1.852 (47.04)	-	.329 (8.36)	.494 (12.55)	1.625 (41.27)	.422 (10.72)	.039 (0.99)	.230 (5.84)	.060 (1.52)	.426 (10.82)	.345 (8.76)
DBMA-25S	2.088 (53.03)	1.511 (38.38)	-	1.852 (47.04)	.311 (7.90)	-	.494 (12.55)	1.625 (41.27)	.422 (10.72)	.030 (0.76)	.243 (6.17)	.048 (1.22)	.429 (10.90)	.345 (8.76)
DCMA-37P	2.729 (69.31)	-	2.182 (55.42)	2.500 (63.50)	-	.329 (8.36)	.494 (12.55)	2.272 (57.71)	.422 (10.72)	.039 (0.99)	.230 (5.84)	.060 (1.52)	.426 (10.82)	.345 (8.76)
DCMA-37S	2.729 (69.31)	2.159 (54.84)	-	2.500 (63.50)	.311 (7.90)	-	.494 (12.55)	2.272 (57.71)	.422 (10.72)	.030 (0.76)	.243 (6.17)	.048 (1.22)	.429 (10.90)	.345 (8.76)
DDMA-50P	2.635 (66.92)	-	2.079 (52.81)	2.406 (61.11)	-	.441 (11.20)	.605 (15.37)	2.178 (55.32)	.534 (13.56)	.039 (0.99)	.230 (5.84)	.060 (1.52)	.426 (10.82)	.345 (8.76)
DDMA-50S	2.635 (66.92)	2.064 (52.43)	-	2.406 (61.11)	.423 (10.74)	-	.605 (15.37)	2.178 (55.32)	.534 (13.56)	.030 (0.76)	.243 (6.17)	.048 (1.22)	.429 (10.90)	.345 (8.76)

Mounting Option Dimensions - Crimp Components

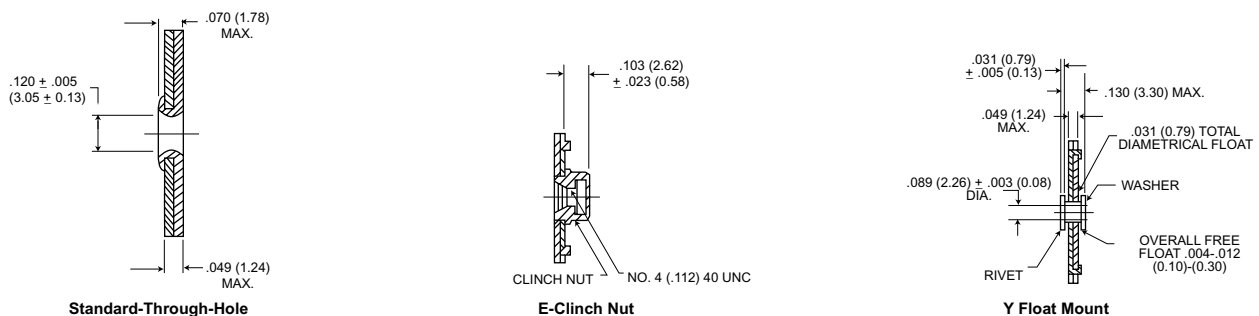

It is recommended that only one assembly, either pin or socket, be float mounted.

Dimensions are shown in inches (millimeters).
Dimensions subject to change.

High Rel Crimp Contacts

MATERIALS AND FINISHES

Contact Size	Wire Size Accom.	Standard Finish				Military Finish		NM	
		Pin		Socket		Pin	Socket	NMB	
		Pin	Socket	Pin	Socket	Pin	Socket	Pin	Socket
20	20, 22, 24	330-5291-000	031-1007-000	330-5291-037	031-1007-042	330-5291-037	031-1007-057		
20-18	1 #18 & 2 #22	330-5291-001	031-1007-001	330-5291-055	031-1007-054	-	-		
20-26	26, 28, 30	330-5291-004	031-1007-004	330-5291-050	031-1007-048	-	-		
22D	22, 24, 26, 28			030-2042-002*	031-1147-002*	-	-		

MIL-C-39029 Cross-Reference

Contact Size	Wire Size Accom.	M39029	M24308	Cannon Part No.
20 Pin	20/22/24	/64-369	/11-1	330-5291-037
20 Socket	20/22/24	/36-368	/10-1	031-1007-042
22D Pin	24/26/28	/58-360	/13-1	030-2042-000
22D Socket	22/24/26/28	/57-354	/12-1	031-1147-000

Assembly Instructions - Page 363

*50 microinch AU over copper, no stripes.

Tooling

Insertion/Extraction Tools

CIET-20HD

Contact Size	AWG	Plastic Insertion/Extraction		Plastic Extraction	
		Part No.	Description	Part No.	Description
20	20, 22, 24	980-2000-426	CIET-20HD	323-7010-000	CET-20-11
2026	26, 28, 30	980-2000-426	CIET 20HD	323-7010-000	CET-20-11
2018	1 #18	None	None	274-5016-002	CET-20-15
	2 #22	None	None	274-5016-002	CET-20-15
22D	22, 24, 26, 28	274-7048-000	CIET 22D	None	None
High Power	12, 16	274-7003-000	CIET 12	None	None
High Volt	#20	274-7003-000	CIET 12	None	None

Hand Crimp Tools



M22520/1-01

M22520/2-01

Contact Size	AWG	Crimp Tool		Locator	
		Part No.	Description	Part No.	Description
		995-0001-584	M22520/2-01	995-0001-604	M22520/2-08
20	20, 22, 24	995-0001-585	M22520/2-01	995-0001-244	TH25
2026	26, 28, 30	995-0001-584	M22520/2-01	995-0001-325	L3198-20HD
2018	1 #18	995-0001-584	M22520/2-01	980-0005-722	K250
	2 #22				
22D	22, 24, 26, 28	995-0001-584	M22520/2-01	995-0001-739	M22520/2-06

Semi-Automatic Crimp Machines

The CBT-646, Vibra-Bowl Crimper is pneumatically powered, electronically controlled machine. It is designed to semi-automatically crimp closed barrel, machined contacts, as used in the aerospace and commercial industries. The machine will accommodate wire sizes 30 thru 12 AWG. The CBT-646 is actuated automatically upon insertion of a pre-stripped stranded or single conductor wire. The CBT-646 meets all Mil. Spec. requirements for crimping closed barrel contacts.

Machine Crimp Rate: 1300 + per hour

Power Requirements: Electrical = 115 Vac., 60 Hz, 5A
Pneumatic = 85 psi., 2 cu. ft. per min.

Products: Most ITT Cannon Commercial and Aerospace closed barrel contacts, wire sizes 30 thru 12 AWG.
(See connector line for part numbers.)

CBT-646

How to Order - High-Rel Printed Circuit Mount Connectors

Straight PC Tail, Receptacles (Includes Socket Contacts) With .120 (3.15) Through-Mounting Holes.



Number of Contacts (Shell Size)	PC Tails - .030 (0.76) Diameter			Wire Wrap Post - .024 (0.61) Square	
	.127 (3.23) ± .027 (0.69) Long Post	.158 (4.01) ± .027 (0.69) Long Post	.183 (4.65) ± .027 (0.69) Long Post	.405 (10.29) ± .027 (0.69) Long Post (Two Wrap)	.530 (13.46) ± .027 (0.69) Long Post (Three Wrap)
9 (E) Standard	DEM9SE	DEM9SM	DEM9SZ	DEM9SF179	DEM9SF179A
9 (E) Military	DEM9SE	DEM9SM	DEM9SZ	DEM9SF179	DEM9SF179A
15 (A) Standard	DAM15SE	DAM15SM	DAM15SZ	DAM15SF179	DAM15SF179A
15 (A) Military	DAM15SE	DAM15SM	DAM15SZ	DAM15SF179	DAM15SF179A
25 (B) Standard	DBM25SE	DBM25SM	DBM25SZ	DBM25SF179	DBM25SF179A
25 (B) Military	DBM25SE	DBM25SM	DBM25SZ	DBM25SF179	DBM25SF179A
37 (C) Standard	DCM37SE	DCM37SM	DCM37SZ	DCM37SF179	DCM37SF179A
37 (C) Military	DCM37SE	DCM37SM	DCM37SZ	DCM37SF179	DCM37SF179A
50 (D) Standard	DDM50SE	DDM50SM	DDM50SZ	DDM50SF179	DDM50SF179A
50 (D) Military	DDM50SE	DDM50SM	DDM50SZ	DDM50SF179	DDM50SF179A

NM Non-Magnetic/No-Outgas - Add desired suffix code (NMB, NM-K52) to end of part number. Example: DEM95ZNM-B-K52

Straight PC Tail, Plug (Includes Pin Contacts) With .120 (3.15) Through-Mounting Holes



Number of Contacts (Shell Size)	PC Tails - .030 (0.76) Diameter			Wire Wrap Post - .024 (0.61) Square	
	.127 (3.23) ± .027 (0.69) Long Post	.158 (4.01) ± .027 (0.69) Long Post	.183 (4.65) ± .027 (0.69) Long Post	.405 (10.29) ± .027 (0.69) Long Post (Two Wrap)	.530 (13.46) ± .027 (0.69) Long Post (Three Wrap)
9 (E) Standard	DEM9PE	DEM9PM	DEM9PZ	DEM9PF179	DEM9PF179A
9 (E) Military	DEM9PE	DEM9PM	DEM9PZ	DEM9PF179	DEM9PF179A
15 (A) Standard	DAM15PE	DAM15PM	DAM15PZ	DAM15PF179	DAM15PF179A
15 (A) Military	DAM15PE	DAM15PM	DAM15PZ	DAM15PF179	DAM15PF179A
25 (B) Standard	DBM25PE	DBM25PM	DBM25PZ	DBM25PF179	DBM25PF179A
25 (B) Military	DBM25PE	DBM25PM	DBM25PZ	DBM25PF179	DBM25PF179A
37 (C) Standard	DCM37PE	DCM37PM	DCM37PZ	DCM37PF179	DCM37PF179A
37 (C) Military	DCM37PE	DCM37PM	DCM37PZ	DCM37PF179	DCM37PF179A
50 (D) Standard	DDM50PE	DDM50PM	DDM50PZ	DDM50PF179	DDM50PF179A
50 (D) Military	DDM50PE	DDM50PM	DDM50PZ	DDM50PF179	DDM50PF179A

NM Non-Magnetic/No-Outgas - Add desired suffix code (NMB, NM-K52) to end of part number. Example: DEM9PZNM-B-K52

Dimensions

Printed Circuit Applications

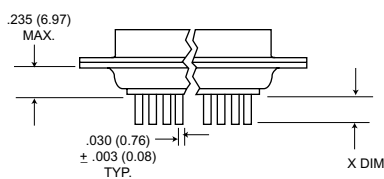

*All MIL-C-24308 connectors come with .250 (0.10) length spacers.

Wire Wrapping Applications

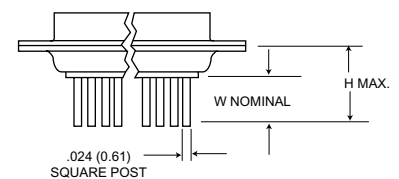

Code (Last Letter of Part Number)	Straight X ± .027 (0.69)	Modification Code	Number of Wraps	W	H
E	.127 (3.22)	F179	2	.405 (10.29)	.655 (16.64)
M	.158 (4.01)	F179A	3	.530 (13.46)	.780 (19.81)
Z	.183 (4.65)				

How to Order - High-Rel Printed Circuit Mount Connectors

Right Angle PC Tail Receptacles, With Bracket (.120 (3.15) Though-Holes Only)



Number of Contacts (Shell Size)	PC Tails - .030 (0.76) Diameter		
	.127 (3.23) ± .027 (0.69) Long Post	.158 (4.01) ± .027 (0.69) Long Post	.183 (4.65) ± .027 (0.69) Long Post
9 (E) Standard	DEM9SD	DEM9SL	DEM9SS
9 (E) Military	DEM9SD	DEM9SL	DEM9SS
15 (A) Standard	DAM15SD	DAM15SL	DAM15SS
15 (A) Military	DAMM15SD	DAMM15SL	DAMM15SS
25 (B) Standard	DBM25SD	DBM25SL	DBM25SS
25 (B) Military	DBMM25SD	DBMM25SL	DBMM25SS
37 (C) Standard	DCM37SD	DCM37SL	DCM37SS
37 (C) Military	DCMM37SD	DCMM37SL	DCMM37SS
50 (D) Standard	DDM50SD	DDM50SL	DDM50SS
50 (D) Military	DDMM50SD	DDMM50SL	DDMM50SS

NM Non-Magnetic/No-Outgas - Add desired suffix cod (NMB, NM-K52) to end of part number. Example: DEM9SLNMB-K52

Right Angle PC Tail Plug, With Bracket (.120 (3.15) Through-Holes Only)



Number of Contacts (Shell Size)	PC Tails - .030 (0.76) Diameter		
	.127 (3.23) ± .027 (0.69) Long Post	.158 (4.01) ± .027 (0.69) Long Post	.183 (4.65) ± .027 (0.69) Long Post
9 (E) Standard	DEM9PD	DEM9PL	DEM9PS
9 (E) Military	DEM9PD	DEM9PL	DEM9PS
15 (A) Standard	DAM15PD	DAM15PL	DAM15PS
15 (A) Military	DAMM15PD	DAMM15PL	DAMM15PS
25 (B) Standard	DBM25PD	DBM25PL	DBM25PS
25 (B) Military	DBMM25PD	DBMM25PL	DBMM25PS
37 (C) Standard	DCM37PD	DCM37PL	DCM37PS
37 (C) Military	DCMM37PD	DCMM37PL	DCMM37PS
50 (D) Standard	DDM50PD	DDM50PL	DDM50PS
50 (D) Military	DDMM50PD	DDMM50PL	DDMM50PS

NM Non-Magnetic/No-Outgas - Add desired suffix cod (NMB, NM-K52) to end of part number. Example: DDM9SLNM-K52

Dimensions-Right Angle 90° D Subminiature

Connectors with brackets cannot be ordered with float mounts or clinch nuts.

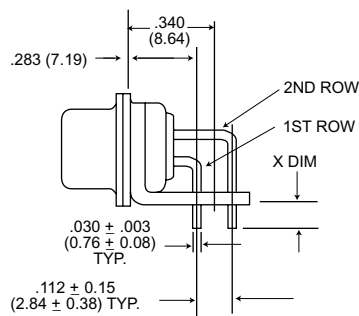

DE, DA, DB, DC Sizes

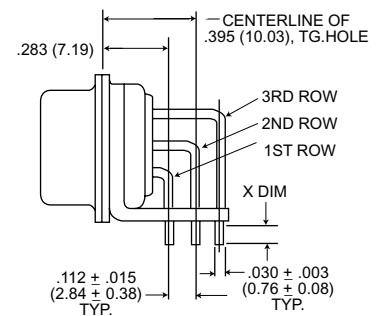

DD Size

Code Last Letter of P/N's	Right Angle With Bracket	X ± .027 (0.69)
D	•	.127 (3.22)
L	•	.158 (4.01)
S	•	.183 (4.65)

PC Board Hole Patterns

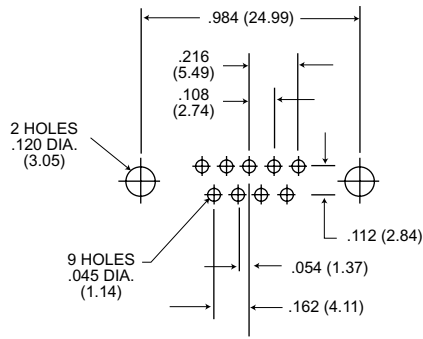

DE Size
9 Positions

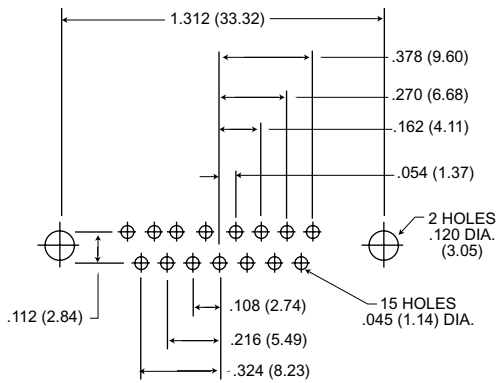

DA Size
15 Positions

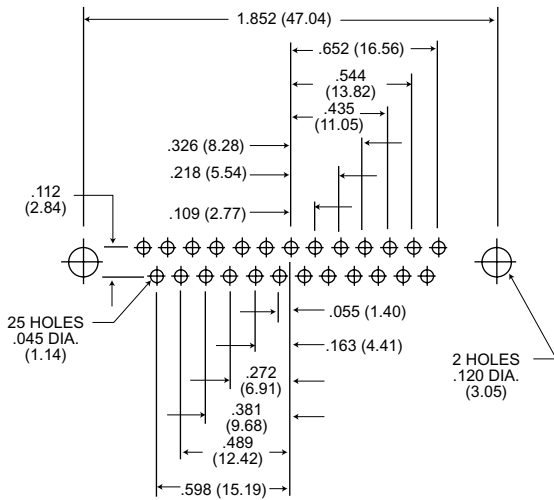

DB Size
25 Positions

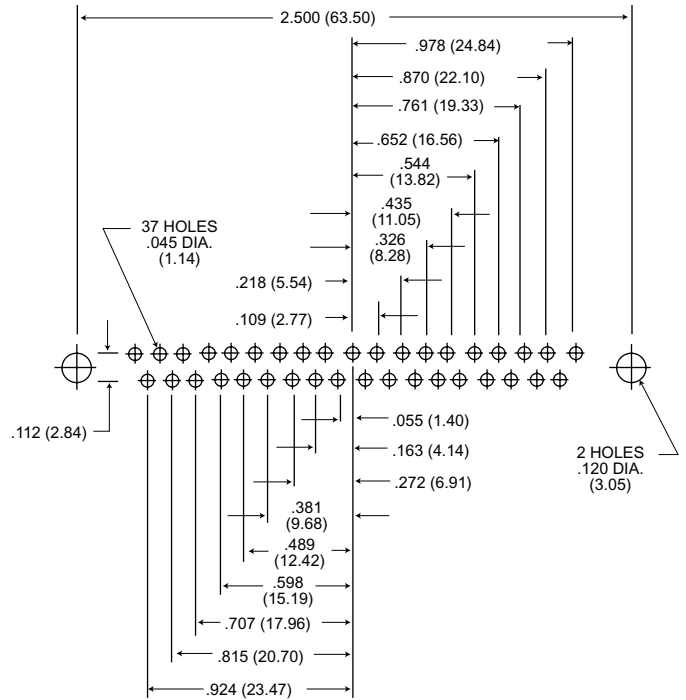

DC Size
37 Positions

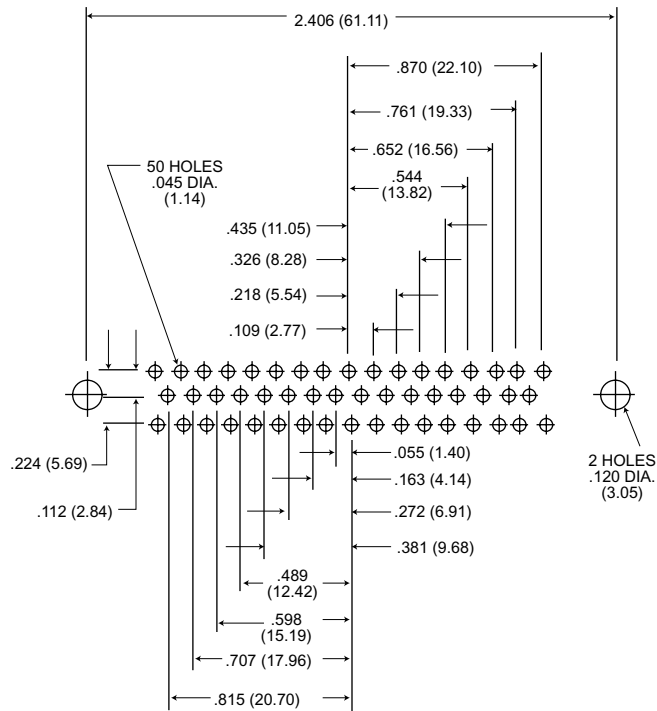

DD Size
50 Positions

MIL-C-24308 Cross Reference

Military Part Number	Cannon Part Number	Military Part Number	Cannon Part Number	Military Part Number	Cannon Part Number
M24308/1-1	DEMMS9S	M24308/2-485	DCMAMY37S-F0	M24308/6-5	DDMAM50SNM
M24308/1-2	DAMM15S	M24308/2-486	DDMAMY50S-F0	M24308/6-6	DEMAMT9SNM
M24308/1-3	DBMM25S	M24308/3-1	DEMMP9P	M24308/6-7	DAMAMT15SNM
M24308/1-4	DCMM37S	M24308/3-2	DAMM15P	M24308/6-8	DBMAMT25SNM
M24308/1-5	DDMM50S	M24308/3-3	DBMM25P	M24308/6-9	DCMAMT37SNM
M24308/1-12	DEMMP9S	M24308/3-4	DCMM37P	M24308/6-10	DDMAMT50SNM
M24308/1-13	DAMMF15S	M24308/3-5	DDMM50P	M24308/6-15	DDMAM78SNM
M24308/1-14	DBMMF25S	M24308/3-12	DEMMP9P	M24308/6-259	DEMAMF9SNM
M24308/1-15	DCMMF37S	M24308/3-13	DAMMF15P	M24308/6-260	DAMAMF15SNM
M24308/1-16	DDMMF50S	M24308/3-14	DBMMF25P	M24308/6-261	DBMAMF25SNM
M24308/1-23	DEMMY9S	M24308/3-15	DCMMF37P	M24308/6-262	DCMAMF37SNM
M24308/1-24	DAMMY15S	M24308/3-16	DDMMF50P	M24308/6-263	DDMAMF50SNM
M24308/1-25	DBMMY25S	M24308/4-1	DEMAM9P	M24308/6-268	DDMAMF78SNM
M24308/1-26	DCMMY37S	M24308/4-2	DAMAM15P	M24308/6-270	DEMAMFT9SNM
M24308/1-27	DDMMY50S	M24308/4-3	DBMAM25P	M24308/6-271	DAMAMFT15SNM
M24308/2-1	DEMAM9S	M24308/4-4	DCMAM37P	M24308/6-272	DBMAMFT25SNM
M24308/2-2	DAMAM15S	M24308/4-5	DDMAM50P	M24308/4-5	DDMAMFT37SNM
M24308/2-3	DBMAM25S	M24308/4-6	DEMAMT9P	M24308/4-6	DDMAMFT50SNM
M24308/2-4	DCMAM37S	M24308/4-7	DAMAMT15P	M24308/4-7	DEMAM9SNM-F0
M24308/2-5	DDMAM50S	M24308/4-8	DBMAMT25P	M24308/4-8	DAMAM15SNM-F0
M24308/2-6	DEMAMT9S	M24308/4-9	DCMAMT37P	M24308/4-9	DDMAM25SNM-F0
M24308/2-7	DAMAMT15S	M24308/4-10	DDMAMT50P	M24308/4-10	DCMAM37SNM-F0
M24308/2-8	DBMAMT25S	M24308/4-15	DDMAM78P	M24308/4-15	DDMAM50SNM-F0
M24308/2-9	DCMAMT37S	M24308/4-259	DEMAM9P-F0	M24308/4-259	DDMAM78SUM-F0
M24308/2-10	DDMAMT50S	M24308/4-260	DAMAM15P-F0	M24308/4-260	DEMAMF9SNM-F0
M24308/2-15	DDMAM78S	M24308/4-261	DBMAM25P-F0	M24308/4-261	DAMAMF15SNM-F0
M24308/2-23	DEMAMF9S	M24308/4-262	DCMAM37P-F0	M24308/4-262	DBMAMF25SNM-F0
M24308/2-24	DAMAMF15S	M24308/4-263	DDMAM50P-F0	M24308/4-263	DCMAMF37SNM-F0
M24308/2-25	DBMAMF25S	M24308/4-268	DDMAM78P-F0	M24308/4-268	DDMAMF50SNM-F0
M24308/2-26	DCMAMF37S	M24308/4-302	DEMAMF9P	M24308/4-302	DDMAMF78SNM-F0
M24308/2-27	DDMAMF50S	M24308/4-303	DAMAMF15P	M24308/4-303	DEMAMY9SNM
M24308/2-32	DDMAMF78S	M24308/4-304	DBMAMF25P	M24308/4-304	DAMAMY15SNM
M24308/2-34	DEMAMFT9S	M24308/4-305	DCMAMF37P	M24308/4-305	DBMAMY25SNM
M24308/2-35	DAMAMFT15S	M24308/4-306	DDMAMF50P	M24308/4-306	DCMAMY37SNM
M24308/2-36	DBMAMFT25S	M24308/4-311	DCMAMF78P	M24308/4-311	DDMAMY50SNM
M24308/2-37	DCMAMFT37S	M24308/4-313	DEMAMFT9P	M24308/4-313	DDMEMYT9SNM
M24308/2-38	DDMAMFT50S	M24308/4-314	DAMAMFT15P	M24308/4-314	DAMAMYT15SNM
M24308/2-281	DEMAM9S-F0	M24308/4-315	DBMAMFT25P	M24308/4-315	DBMAMYT25SNM
M24308/2-282	DAMAM15S-F0	M24308/4-316	DCMAMFT37P	M24308/4-316	DCMAMYT37SNM
M24308/2-283	DBMAM25S-F0	M24308/4-317	DDMAMFT50P	M24308/4-317	DDMAMYT50SNM
M24308/2-284	DCMAM37S-F0	M24308/4-324	DEMAMF9P-F0	M24308/4-324	DEMAMY9SNM-F0
M24308/2-285	DDMAM50S-F0	M24308/4-325	DAMAMF15P-F0	M24308/4-325	DAMAMY15SNM-F0
M24308/2-290	DDMAM78S-F0	M24308/4-326	DBMAMF25P-F0	M24308/4-326	DBMAMY25SNM-F0
M24308/2-292	DEMAMF9S-F0	M24308/4-327	DCMAMF37P-F0	M24308/4-327	DCMAMY37SNM-F0
M24308/2-293	DAMAMF15S-F0	M24308/4-328	DDMAMF50P-F0	M24308/4-328	DDMAMY50SNM-F0
M24308/2-294	DBMAMF25S-F0	M24308/4-333	DDMAMF78P-F0	M24308/7-1	DEMM9PNM
M24308/2-295	DCMAMF37S-F0	M24308/5-1	DEMMP9SNM	M24308/7-2	DAMM15PNM
M24308/2-296	DDMAMF50S-F0	M24308/5-2	DAMM15SNM	M24308/7-3	DBMM25PNM
M24308/2-301	DDMAMF78S-F0	M24308/5-3	DBMM25SNM	M24308/7-4	DCMM37PNM
M24308/2-335	DBMAMR25S	M24308/5-4	DCMM37SNM	M24308/7-5	DDMMS0PNM
M24308/2-336	DCMAMR37S	M24308/5-5	DDMM50SNM	M24308/7-12	DEMMP9PNM
M24308/2-341	DAMAMR15S	M24308/5-12	DEMMP9SNM	M24308/7-13	DAMMF15PNM
M24308/2-342	DEMAMY9S	M24308/5-13	DAMMF15SNM	M24308/7-14	DBMMF25PNM
M24308/2-343	DAMAMY15S	M24308/5-14	DBMMF25SNM	M24308/7-15	DCMMF37PNM
M24308/2-344	DBMAMY25S	M24308/5-15	DCMMF37SNM	M24308/7-16	DDMMF50PNM
M24308/2-345	DCMAMY37S	M24308/5-16	DDMMF50SNM	M24308/8-1	DEMAM9PNM
M24308/2-346	DDMAMY50S	M24308/5-23	DDMMY9SNM	M24308/8-2	DAMAM15PNM
M24308/2-353	DEMAMYT9S	M24308/5-24	DAMMY15SNM	M24308/8-3	DBMAM25PNM
M24308/2-354	DAMAMYT15S	M24308/5-25	DBMMY25SNM	M24308/8-4	DCMAM37PNM
M24308/2-355	DBMAMYT25S	M24308/5-26	DCMMY37SNM	M24308/8-5	DDMAM50PNM
M24308/2-356	DCMAMYT37S	M24308/5-27	DDMMY50SNM	M24308/8-6	DEMAMT9PNM
M24308/2-357	DDMAMYT50S	M24308/6-1	DEMAM9SNM	M24308/8-7	DAMAMT15PNM
M24308/2-482	DEMAMY9S-F0	M24308/6-2	DAMAM15SNM	M24308/8-8	DBMAMT25PNM
M24308/2-483	DEMAMY15S-F0	M24308/6-3	DBMAM25SNM	M24308/8-9	DCMAMT37PNM
M24308/2-484	DEMAMY25S-F0	M24308/6-4	DCMAM37SNM	M24308/8-10	DDMAMT50PNM

MIL-C-24308 Cross Reference (Continued)

Military Part Number	Cannon Part Number	Military Part Number	Cannon Part Number	Military Part Number	Cannon Part Number
M24308/8-15	DDMAM78PNM	M24308/23-8	DAMM15SZ	M24308/24-8	DAMM15PZ
M24308/8-259	DEMAM9PNM-FO	M24308/23-9	DBMM25SZ	M24308/24-9	DBMM25PZ
M24308/8-260	DAMAM15PNM-FO	M24308/23-10	DCMM37SZ	M24308/24-10	DCMM37PZ
M24308/8-261	DBMAM25PNM-FO	M24308/23-11	DDMM50SZ	M24308/24-11	DDMM50PZ
M24308/8-262	DCMAM37PNM-FO	M24308/23-13	DEMM9SH	M24308/24-13	DEMM9PH
M24308/8-263	DDMAM50PNM-FO	M24308/23-14	DAMM15SH	M24308/24-14	DAMM15PH
M24308/8-269	DDMAM78PNM-FO	M24308/23-15	DBMM25SH	M24308/24-15	DBMM25PH
M24308/8-302	DEMAMF9PNM	M24308/23-16	DCMM37SH	M24308/24-16	DCMM37PH
M24308/8-303	DAMAMF15PNM	M24308/23-17	DDMM50SH	M24308/24-17	DDMM50PH
M24308/8-304	DBMAMF25PNM	M24308/23-19	DEMM9SX	M24308/24-19	DEMM9PX
M24308/8-305	DCMAMF37PNM	M24308/23-20	DAMM15SX	M24308/24-20	DAMM15FX
M24308/8-306	DDMAMF50PNM	M24308/23-21	DBMM25SX	M24308/24-21	DBMM25PX
M24308/8-311	DDMAMF78PNM	M24308/23-22	DCMM37SX	M24308/24-22	DCMM37PX
M24308/8-313	DEMAMFT9PNM	M24308/23-23	DDMM50SX	M24308/24-23	DDMM50PX
M24308/8-314	DAMAMFT15PNM	M24308/23-25	DEMM9SD	M24308/24-25	DEMM9PD
M24308/8-315	DBMAMFT25PNM	M24308/23-26	DAMM15SD	M24308/24-26	DAMM15PD
M24308/8-316	DCMAMFT37PNM	M24308/23-27	DBMM25SD	M24308/24-27	DBMM25PD
M24308/8-317	DDMAMFT50PNM	M24308/23-28	DCMM37SD	M24308/24-28	DCMM37PD
M24308/8-324	DEMAMF9PNM-FO	M24308/23-29	DDMM50SD	M24308/24-29	DDMM50PD
M24308/8-325	DAMAMF15PNM-FO	M24308/23-31	DEMM9SL	M24308/24-31	DEMM9PL
M24308/8-326	DBMAMF25PNM-FO	M24308/23-32	DAMM15SL	M24308/24-32	DAMM15PL
M24308/8-327	DCMAMF37PNM-FO	M24308/23-33	DBMM25SL	M24308/24-33	DBMM25PL
M24308/8-328	DDMAMF50PNM-FO	M24308/23-34	DCMM37SL	M24308/24-34	DCMM37PL
M24308/3-333	DDMAMF78PNM-FO	M24308/23-35	DDMM50SL	M24308/24-35	DDMM50PL
M24308/9-1	DEH9P002	M24308/23-37	DEMM9SA	M24308/24-37	DEMM9PA
M24308/9-2	DAH15P002	M24308/23-38	DAMM15SA	M24308/24-38	DAMM15PA
M24308/9-3	DBH25P002	M24308/23-39	DBMM25SA	M24308/24-39	DBMM25PA
M24308/9-4	DCH37P002	M24308/23-40	DCMM37SA	M24308/24-40	DCMM37PA
M24308/9-5	DDH50P002	M24308/23-41	DDMM50SA	M24308/24-41	DDMM50PA
M24308/9-6	DEH9P001	M24308/23-43	DEMM9SG	M24308/24-43	DEMM9PG
M24308/9-7	DAH15P001	M24308/23-44	DAMM15SG	M24308/24-44	DAMM15PG
M24308/9-8	DBH25P001	M24308/23-45	DBMM25SG	M24308/24-45	DBMM25PG
M24308/9-9	DCH37P001	M24308/23-46	DCMM37SG	M24308/24-46	DCMM37PG
M24308/9-10	DDH50P001	M24308/23-47	DDMM50SG	M24308/24-47	DDMM50PG
M24308/9-11	DEH9P202	M24308/23-49	DEMM9SS	M24308/24-49	DEMM9PS
M24308/9-12	DAH15P202	M24308/23-50	DAMM15SS	M24308/24-50	DAMM15PS
M24308/9-13	DBH25P202	M24308/23-51	DBMM25SS	M24308/24-51	DBMM25PS
M24308/9-14	DCH37P202	M24308/23-52	DCMM37SS	M24308/24-52	DCMM37PS
M24308/9-15	DDH50P202	M24308/23-53	DDMM50SS	M24308/24-53	DDMM50PS
M24308/9-16	DEH9P201	M24308/23-55	DEMM9SW	M24308/24-55	DEMM9PW
M24308/9-17	DAH15P201	M24308/23-56	DAMM15SW	M24308/24-56	DAMM15PW
M24308/9-18	DBH25P201	M24308/23-57	DBMM25SW	M24308/24-57	DBMM25PW
M24308/9-19	DCH37P201	M24308/23-58	DCMM37SW	M24308/24-58	DCMM37PW
M24308/9-20	DDH50P201	M24308/23-59	DDMM50SW	M24308/24-59	DDMM50PW
M24308/23-1	DEMM9SM	M24308/24-1	DEMM9PM	M24308/26-1	D20418-2
M24308/23-2	DAMM15SM	M24308/24-2	DAMM15PM	M24308/26-2	D20418-39
M24308/23-3	DBMM25SM	M24308/24-3	DBMM25PM		
M24308/23-4	DCMM37SM	M24308/24-4	DCMM37PM		
M24308/23-5	DDMM50SM	M24308/24-5	DDMM50PM		
M24308/23-7	DEMM9SZ	M24308/24-7	DEMM9PZ		

Crimp



(See page 342)

Printed Circuit



(See page 343)

Performance and Material Specifications

MATERIALS AND FINISHES

	Standard		Military	
	Material	Finish	Material	Finish
Shell	Steel per ASTM A-620	Yellow chromate over cadmium QQ-P-416 Type II Class 2	Steel per ASTM A-620	Yellow chromate over cadmium QQ-P-416 Type II Class 2
Insulator	Diallyl phthalate glass-filled per MIL-M-14, type SDG-F color green	-	Diallyl phthalate glass-filled per MIL-M-14, type SDG-F color green	-
Contact	Copper alloy	Gold over nickel	Copper alloy Crimp socket has stainless steel hood	Gold 50 microinches minimum thickness per MIL-G-45204 Type II Grade C Class 1 over copper per MIL-C-14550 Hood: Passivated
Float Mount Hardware	Stainless steel	Passivate per QQ-P-35	Stainless steel	Passivate per QQ-P-35

PERFORMANCE SPECIFICATIONS

Wire Accommodation (AWG)	Crimp-#22-#28 AWG
Current Rating	#22: 5 Amp
Temperature Rating	-65°C to +150°C
Contact Resistance After Salt Spray, Millivolt Max.	55 @ 5 Amp test current

DIELECTRIC WITHSTANDING VOLTAGE

Test	90° and Straight (Solder/Crimp)		
	Altitude (feet/m)		
	Sea Level	70,000/21,336	100,000
	1000	325	175

All voltage figures are rms AC 60 rms cps, measured at approximately +25°C, 50% rh. For additional performance specifications refer to MIL-C-24308 Test Extracts on page 385.

Contact Arrangements

Face View Pin Insert

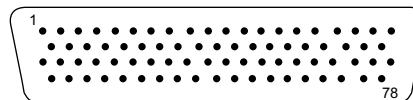

Shell Size
Contact Arrangement
Contact Size

D
78
#22

How to Order - Crimp Connectors



Receptacle (Includes Socket Contacts) With .120" Through-Mounting Holes

Number Contacts (Shell Size)	Standard Version	Military Version
78 (D)	DDMA78S	DDMAM78S

Plugs (Includes Pin Contacts)* With .120" Through-Mounting Holes

Number Contacts (Shell Size)	Standard Version	Military Version
78 (D)	DDMA78P	DDMAM78P

Note: 1) To receive the connector without contacts, add "FO" to end of part number.

Example: DBMA25SFO, DBMAM25SFO.
2) For loose contacts and tooling see page 5.

Mounting Options Available:

- 4-40 Clinch Nut - ADD "E" to Part Number After "M" or "A"
 - 4-40 Float Mount - Add "Y" to Part Number After "M" or "A"
- (Can be used in front or rear panel mount applications)

Dimensions - Crimp Connectors

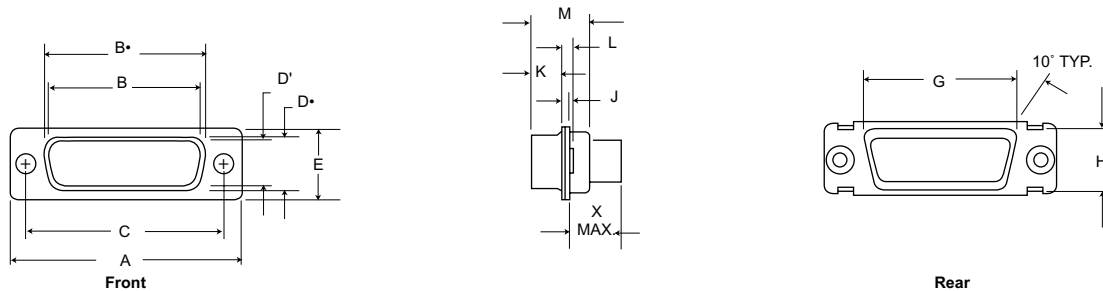

Part Number by Shell Size	A	B*	B'	C	D*	D'	E	G	H	J	K	L	M	X Max
DDM78P	2.635 (66.92)	-	2.079 (52.81)	2.406 (61.11)	-	.441 (11.20)	.605 (15.37)	2.178 (55.32)	.534 (13.56)	.039 (0.99)	.231 (5.87)	.060 (1.52)	.426 (10.82)	.345 (8.76)
DDM78S	2.635 (66.92)	2.064 (52.43)	-	2.406 (61.11)	.423 (10.41)	-	.605 (15.37)	2.178 (55.32)	.534 (13.56)	.030 (0.76)	.243 (6.17)	.045 (1.14)	.429 (10.90)	.345 (8.76)

Mounting Option Dimensions

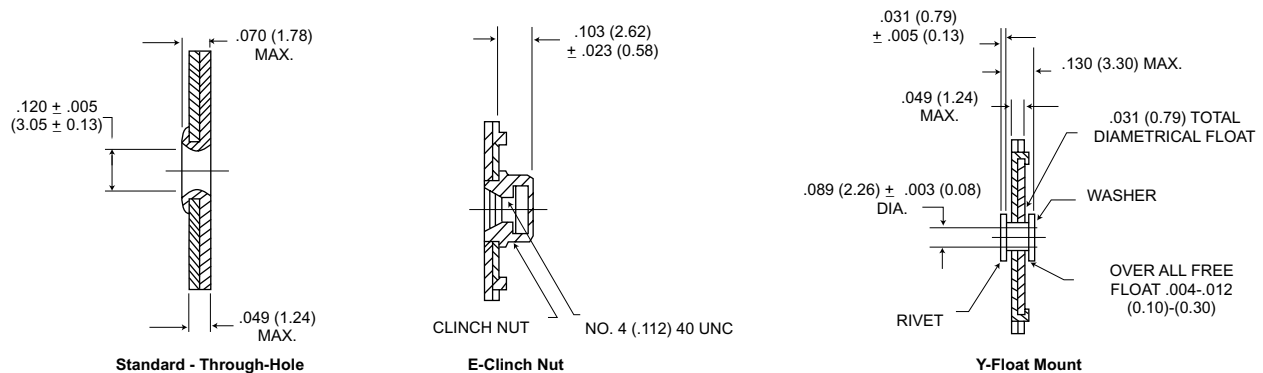

It is recommended that only on assembly, either pin or socket, be float mounted.

High Rel Printed Circuit Mount Connector - Straight PC Tail



Receptacle



Plug

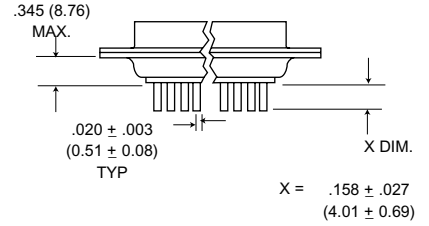

With .120 (3.15) Through-Mounting Holes

Number Contacts (Shell Size)		NM Non-Magnetic			
		Receptacle	Receptacle	Plug	Plug
78 (D) Standard		DDMA50913-499	-	DDMA50913-500	-
78 (D) Military		DDMA50913-439	DDMA50913-445	DDMA50913-440	DDMA50913-446

High Rel 90° PCB Connectors



Receptacle



Plug

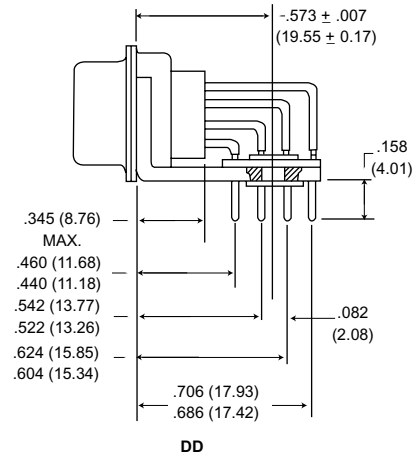

DD

Connectors with brackets cannot be ordered with float mounts or clinch nuts.

Number Contacts (Shell Size)		NM Non-Magnetic			
		Receptacle	Receptacle	Plug	Plug
78 (0) Standard		DDMA50913-467	-	DDMA50913-468	-
78 (0) Military		DDMA50913-437	DDMA50913-473	DDMA50913-438	DDMA50913-474

High Rel Crimp Contacts

Contact Size	Wire Size Accommodation	Cannon Part Number			
		M39029	M24308*	Pin	Socket
22D Pin	22, 24, 26, 28	/58-360	/13-1	030-2042-00	-
22D Socket	22, 24, 26, 28	/57-354	/12-1	-	031-1147-000

* Superseded by M39029

Straight and 90° Board Hole Patterns

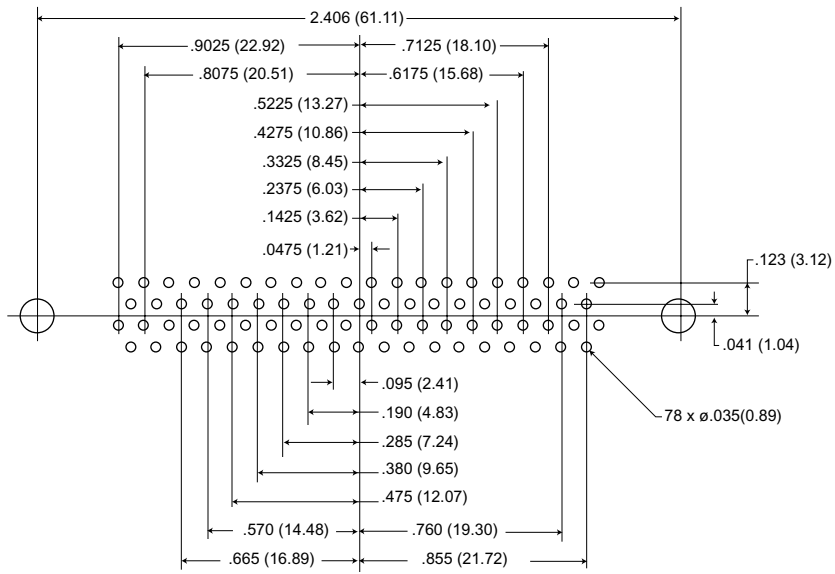

DD-78

Tooling

Hand Tools

Contact Size	AWG	Plastic Insertion/Extraction	Crimp Tool	Locator
22D	22, 24, 26, 28	274-7048-000 CIET-22D	995-0001-584 M22520/2-01	995-0001-739 M22520/2-06

Combo D[®]

Combination D Subminiature connectors are the fastest growing segment of the D Subminiature market. ITT Cannon engineering teams, in keeping pace with the demands of the industry, have developed the broadest selection of combination D Subminiature available.

We offer the ability to intergrate signal and coax, high power, and high voltage. You can mix red, green, and blue video lines with signal and up to 40 amps of power in the same package.

Design variations of the new Combo D connector, versus other packaging methods, include the proven ITT Cannon polarized "D" shape to prevent mismatching; dense, space-saving packaging; and diverse mounting options. Choose from a variety of cable and printed wiring board selections. Printed wiring board combos come pre-assembled with fixed contacts eliminating the need to buy several components.

This new line of connectors offers you **unlimited design versatility**.



Straight and right angle printed wiring board contacts are available in both coax and high power versions.

Performance and Material Specifications

CONNECTOR ASSEMBLIES

Description	Material	Finish
Shell	Steel or Brass	Yellow Chromate Cadmium or Gold over Nickel
Insulator	Thermoplastic or Diallyl Phthalate, UL 94V-0 rated.	None
Size 20 contacts when applicable	Copper alloy	50μ inches gold over copper or 100μ gold over copper.
Bracket	Steel	Yellow Chromate over Cadmium
Rivnut	Steel or Copper alloy	

COAXIAL ASSEMBLY

Contacts and shells	Copper alloy	Gold over nickel or 50μ inches gold over copper.
Ring, retaining	Copper alloy	Nickel or Gold
Insulator	Teflon	None
U.L. File Number: E8572		

DIELECTRIC WITHSTANDING VOLTAGE

Type of Contact		Altitude (feet/m)							
		Sea Level		20,000/6096		50,000/15240		70,000/1336	
		90'	Straight	90'	Straight	90'	Straight	90'	Straight
Center Conductor to Coaxial Shell	Average Flashover	1200	1500	900	1000	600	700	400	500
	Test	800	1000	600	650	400	475	275	325
Coaxial Shell to Nearest Standard Solder Pot Contact	Average Flashover	•	1500	•	1500	•	900	•	650
	Test	•	1000	•	1000	•	600	•	425
High Power contact and/or Coaxial Shell to Plug Shell	Average Flashover	1500	1500	1000	1000	500	500	500	500
	Test	1000	1000	650	650	325	325	325	325
#20 Signal	Average Flashover	1700		1000		650		500	
	Test	1250		750		475		375	
HV Contact to Nearest Contact or to Shell	Average Flashover	3800	3800	2300	2300	900	900	650	650
	Test	2800	2800	1700	1700	675	675	475	475

All voltage figures are rms AC 60 rms cps, measured at approximately +25°C, 50% rh.

Impedance: 50 ohm

PERFORMANCE DATA

Signal Contact Current Rating	5 Amp
Temperature Rating	-65°C to +150°C
Signal Contact Resistance millivolt max	55 @ 7.5 Amp test current
Coax Impedance	50 ohm
Coax VSWR	Less than 1.3-1.0 up to 500 megahertz
Coax Insertion Loss	.1 db loss at 500 megahertz.

See *Commercial D Subminiature* catalog for additional Combo D options, including 75 ohm Coax.

Combo D® - Coaxial/ 75 and 50 Ohm

Coaxial Housing With Solder Cup Signal Contacts



- Cable combinations supplied with preloaded solder signal contacts
- 50 ohm coax contacts supplied separately (see pages 347-348)

Clinch Nut and Float Mount Options Available:

Add: E = 4-40 Clinch Nut

Y = Float Mounting

Example: DAMME3W3P

DANNT3W3P

Mounting Method Detail - Page 334.

Layout	Military Socket	Military Pin	NM Non-Magnetic Socket	NM Non-Magnetic Pin
DE-5W1	DEMMSW1S	DMM5W1P	DEM5W1S-NMB-K52	DEM5W1P-NMB-K52
DA-7W2	DAMM7W2S	DAMM7W2P	DAM7W2S-NMB-K52	DAM7W2P-NMB-K52
DA-11W1	DAMM11W1S	DAMM11W1P	DAM11W1S-NMB-K52	DAM11W1P-NMB-K52
DA-3W3	DAMM3W3S	DAMM3W3P	DAM3W3S-NMB-K47	DAM3W3P-NMB-K47
DB-5W5	DBMM5W5S	DBMM5W5P	DBM5W5S-NMB-K47	DBM5W5P-NMB-K47
DB-9W4	DBMM9W4S	DBMM9W4P	DBM9W4S-NMB-K52	DBM9W4P-NMB-K52
DB-13W3	DBMM13W3S	DBMM13W3P	DBM13W3S-NMB-K52	DBM13W3P-NMB-K52
DB-17W2	DBMM17W2S	DBMM17W2P	DBM17W2S-NMB-K52	DBM17W2P-NMB-K52
DB-21W1	DBMM21W1S	DBMM21W1P	DBM21W1S-NMB-K52	DBM21W1P-NMB-K52
DC-8W8	DCMM8W8S	DCMM8W8P	DCM8W8S-NMB-K47	DCM8W8P-NMB-K47
DC-13W6	DCMM13W6S	DCMM13W6P	DCM13W6S-NMB-K52	DCM13W6P-NMB-K52
DC-17W5	DCMM17W5S	DCMM17W5P	DCM17W5S-NMB-K52	DCM17W5P-NMB-K52
DC-21WA4	DCMM21WA4S	DCMM21WA4P	DCM21WA4S-NMB-K52	DCM21WA4P-NMB-K52
DC-25W3	DCMM25W3S	DCMM25W3P	DCM25W3S-NMB-K52	DCM25W3P-NMB-K52
DC-27W2	DCMM27W2S	DCMM27W2P	DCM27W2S-NMB-K52	DCM27W2P-NMB-K52
DD-24W7	DDMM24W7S	DDMM24W7P	DDM24W7S-NMB-K52	DDM24W7P-NMB-K52
DD-36W4	DDMM36W4S	DDMM36W4P	DDM36W4S-NMB-K52	DDM36W4P-NMB-K52
DD-43W2	DDMM43W2S	DDMM43W2P	DDM43W2S-NMB-K52	DDM43W2P-NMB-K52
DD-47W1	DDMM47W1S	DDMM47W1P	DDMC47W1S-NMB-K52	DDM47W1P-NMB-K52

Contact Arrangements

(Will accommodate Removable Coax, Power and/or High Voltage Contacts)

Note: Color Code - Pin Connector: Red, Socket Connector: Blue

Shell Size	E	A	A	A	B	B
Contact Arrangement	5W1	3W3	7W2	11W1	5W5	9W4
No. of Signal Contacts	4 #20	0	5 #20	10 #20	0	5 #20
No. of Coaxial Contacts	1	3	2	1	5	4
Shell Size	B	B	B	C		
Contact Arrangement	13W3	17W2	21W1	8W8		
No. of Signal Contacts	10 #20	15 #20	20 #20	0		
No. of Coaxial Contacts	3	2	1	8		
Shell Size	C	C	C	C		
Contact Arrangement	13W6	17W5	21WA4	25W3		
No. of Signal Contacts	7 #20	12 #20	17 #20	22 #20		
No. of Coaxial Contacts	6	5	4	3		
Shell Size	C	D	D			
Contact Arrangement	27W2	24W7	36W4			
No. of Signal Contacts	25 #20	17 #20	32 #20			
No. of Coaxial Contacts	2	7	4			
Shell Size	D					
Contact Arrangement	43W2					
No. of Signal Contacts	41 #20					
No. of Coaxial Contacts	2					
Shell Size	D					
Contact Arrangement	47W1					
No. of Signal Contacts	46 #20					
No. of Coaxial Contacts	1					

See *Commerical D Subminiature* catalog for additional Combo D options, including 75 ohm Coax.

Combo D® - Coaxial/50 Ohm

Cable Combinations - 50 Ohm Coaxial Contacts

Color Code: Receptacle - Blue; Plug - Red

Straight Crimp Braid

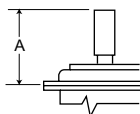

(Dimensions include outer sleeve).

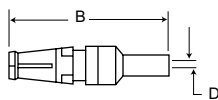

Receptacle

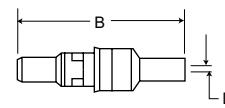

Plug

	Crimp/Crimp Gold Over Nickel	Gold Over Nickel	50µ in. Gold Over Copper	<i>NM</i> - Non-Magnetic 50µ in. Gold Over Copper	A Max.	B Max.	D Min.	RG Cable No.	
								Old	New
Plug		DM53740	DM53740-17		.739 (18.8)	.945 (24.00)	.040 (1.00)	196/U	178B/U
Plug	DM53740-37*	DM53740-1	DM53740-15	DM53740-36	.739 (18.8)	.945 (24.00)	.067 (1.70)	187/U	179B/U
Plug		DM53740-35			.739 (18.8)	.945 (24.00)	.067 (1.70)	-	RD316
Plug		DM53740-3	DM53740-16		.847 (21.5)	1.037 (26.34)	.110 (2.79)	195/U	180B/U
Plug		DM53740-5	DM53740-18		.847 (21.5)	1.037 (26.34)	.125 (3.18)	58/U	58B/U
Receptacle		DM53742	DM53742-18		.739 (18.8)	.945 (24.00)	.040 (1.00)	196/U	1788/U
Receptacle	DM53742-38*	DM53742-1	DM53742-16	DM53742-37	.739 (18.8)	.945 (24.00)	.067 (1.70)	187/U	179B/U
Receptacle		DM53742-36			.739 (18.8)	.945 (24.00)	.067 (1.70)	-	RD316
Receptacle		DM53742-3	DM53742-17		.847 (21.5)	1.037 (26.34)	.110 (2.79)	195/U	180B/U
Receptacle		DM53742-5	DM53742-19		.847 (21.5)	1.037 (26.34)	.125 (3.18)	58/U	58B/U

* Consult factory for center contact crimp tooling.

Straight Crimp Braid

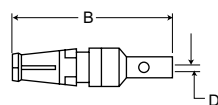
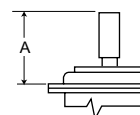

Receptacle

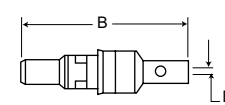

Plug

	Gold Over Nickel	50µ in. Gold Over Copper	<i>NM</i> - Non-Magnetic 50µ in. Gold Over Copper	A Max.	B Max.	D Min.	RG Cable No.	
							Old	New
Plug	DM53740-5008	DM53740-5105		.739 (18.8)	.945 (24.00)	.040 (1.00)	196/U	178B/U
Plug	DM53740-5001	DM53740-5099	DM53740-5147	.739 (18.8)	.945 (24.00)	.067 (1.70)	187/U	179B/U
Plug	DM53740-5145			.739 (18.8)	.945 (24.00)	.067 (1.70)	-	RD316
Plug	DM53740-5002	DM53740-5104		.847 (21.5)	1.037 (26.34)	.110 (2.79)	195/U	180B/U
Plug	DM53740-5005	DM53740-5101		.847 (21.5)	1.037 (26.34)	.125 (3.18)	58/U	58/U
Receptacle	DM53742-5006	DM53742-5092		.739 (18.8)	.945 (24.00)	.040 (1.00)	196/U	178B/U
Receptacle	DM53742-5001	DM53742-5089	DM53742-5127	.739 (18.8)	.945 (24.00)	.067 (1.70)	187/U	179B/U
Receptacle	DM53742-5126			.739 (18.8)	.945 (24.00)	.067 (1.70)	-	RD316
Receptacle	DM53742-5002	DM53742-5091		.847 (21.5)	1.037 (26.34)	.110 (2.79)	195/U	180B/U
Receptacle	DM53742-5004	DM53742-5086		.847 (21.5)	1.037 (26.34)	.125 (3.18)	58/U	58/U
Plug (Short Type)	DM53740-5000	DM53740-5100	.670 (17.0)	.874 (22.20)	.045 (1.14)	196/U	178B/U	
Receptacle (Short Type)	DM53742-5000	DM53742-5085	.670 (17.0)	.874 (22.20)	.045 (1.14)	196/U	178B/U	

Right Angle Solder Braid

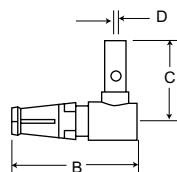
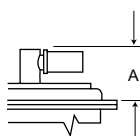

Receptacle

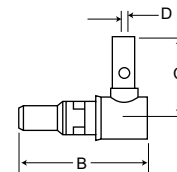

Plug

	Gold Over Nickel	50µ in. Gold Over Copper	A Max.	B Max.	C	D Min.	RG Cable No.	
							Old	New
Plug	DM53741-5000	DM53741-5059	.530 (13.46)	.745 (18.92)	.544 (15.10)	.040 (1.00)	196/U	178B/U
Plug	DM53741-5001	DM53741-5062	.530 (13.46)	.745 (18.92)	.544 (15.10)	.067 (1.70)	187/U 188/U	178B/U 316B/U
Plug	DM53741-5003	DM53741-5063	.530 (13.46)	.745 (18.92)	.630 (16.00)	.110 (2.79)	195/U	180B/U
Plug	DM53741-5004	DM53741-5060	.530 (13.46)	.745 (18.92)	.630 (16.00)	.125 (3.18)	58/U	58/U
Receptacle	DM53743-5000	DM53743-5073	.530 (13.46)	.745 (18.92)	.594 (15.09)	.040 (1.00)	196/U	178B/U
Receptacle	DM53743-5001	DM53743-5076	.530 (13.46)	.745 (18.92)	.594 (15.09)	.067 (1.70)	187/U 188/U	179B/U 316B/U
Receptacle	DM53743-5003	DM53743-5077	.530 (13.46)	.745 (18.92)	.630 (16.00)	.110 (2.79)	195/U	180B/U
Receptacle	DM53743-5004	DM53743-5074	.530 (13.46)	.745 (18.92)	.630 (16.00)	.125 (3.18)	58/U	58B/U

Highlighted part numbers indicate standard product; usually available with shorter lead times.

See *Commerical D Subminiature* catalog for additional Combo D options, including 75 ohm Coax.

Combo D® - Coaxial/50 Ohm

Cable Combinations - 50 Ohm Coaxial Contacts (Continued)

Right Angle Crimp Braid

(Dimensions include outer sleeve.)
Color Code: Receptacle - Blue; Plug - Red

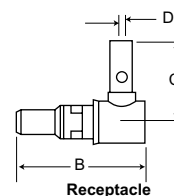
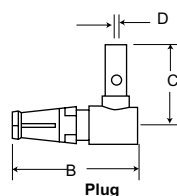
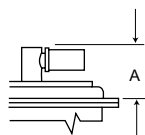

	Part Number		A Max.	B Ref.	C	D ± .005 (0.13)	RG Cable No.	
	Gold Over Nickel	50µ in. Gold Over Copper					Old	New
Plug	DM53741	DM53741-12	.530 (13.46)	.745 (18.92)	.594 (15.10)	.045 (1.14)	196/U	178B/U
Plug	DM53741-1	DM53741-11	.530 (13.46)	.745 (18.92)	.594 (15.10)	.072 (1.83)	187/U	179B/U
							188/U	316B/U
Plug	DM53741-3	DM53741-10	.530 (13.46)	.745 (18.92)	.630 (16.00)	.110 (2.79)	195/U	180B/U
Plug	DM53741-4	DM53741-13	.530 (13.46)	.745 (18.92)	.630 (16.00)	.125 (3.18)	58/U	58B/U
Receptacle	DM53743-2	DM53743-18	.530 (13.46)	.745 (18.92)	.594 (15.10)	.045 (1.14)	196/U	178B/U
Receptacle	DM53743-3	DM53743-16	.530 (13.46)	.745 (18.92)	.594 (15.10)	.072 (1.83)	187/U	179B/U
							188/U	316B/U
Receptacle	DM53743-5	DM53743-17	.530 (13.46)	.745 (18.92)	.630 (16.00)	.110 (2.79)	195/U	180B/U
Receptacle	DM53743-6	DM53743-19	.530 (13.46)	.745 (18.92)	.630 (16.00)	.125 (3.18)	58/U	58B/U

Insertion/Extraction Instructions

Coaxial, High Power and High Voltage Contacts

Insertion

No insertion tool is required. The contact is easily snapped in from the rear of the connector.

RED COLOR CODED CONNECTOR
ACCEPTS PLUG CONTACTS.

BLUE COLOR CODED CONNECTORS ACCEPTS RECEPTACLE
CONTACTS INSERT FROM TERMINAL END AS SHOWN BELOW.

INSERT

INSERT

PLUG CONTACT
D*M PLUG

RECEPTACLE CONTACT
D*M RECEPTACLE

Extraction

CET-C6B

The CET-C6B tool extracts coaxial, high power and high voltage contacts (Plug and receptacle). Part number 070064-0000.

Operating Instructions:

To extract the coax contact, hold the tool by the body and insert the tip into the front of the contact cavity until it bottoms and closes the coax retaining ring. Holding the body in this position securely enough to keep coax retaining ring closed, push the plunger; contact will be pushed out of the rear of the assembly.

TOOL PLUNGER
COAXIAL, H.V., OR
POWER CONTACTS
EXTRACT

TOOL TIP
EXTRACTION TOOL CET-C6B

Hand Tool with intergral die set for all coax straight crimp braid. Part Number: 070051-0000 (CCT-DM)

See *Commerical D Subminiature* catalog for additional Combo D options, including 75 ohm Coax.

Combo D® - Coaxial/50 Ohm

Coax Assembly Instructions

Trim Dimensions

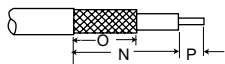

RG Cable No.	Straight			Right Angle		
	N	O	P	N	O	P
196/U, 178B/U, 187/U 188/U, 179B/U, 316B/U	.312 (7.92)	.250 (6.35)	.078 (1.98)	.375 (9.52)	.234 (5.94)	.062 (1.57)
195/U, 180B/U 58/U, 58B/U	.375 (9.52)	.312 (7.92)	.078 (1.98)	.422 (10.69)	.312 (7.92)	.094 (2.39)

All tolerances $\pm .010$ (0.25)

Crimp Tooling

RG Cable No.	Tool P/N	Description	Closure
196/U, 178B/U	070051-0000	CCT-DM	C
187/U, 179B/U 188/U, 316B/U	070051-0000	CCT-DM	B
195/U, 180B/U 58/U, 58B/U	070051-0000	CCT-DM	A

90° Coaxial

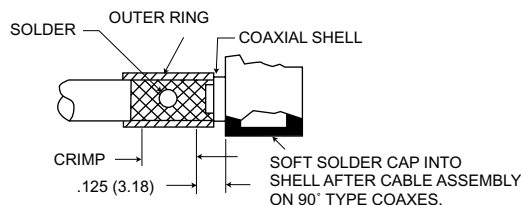
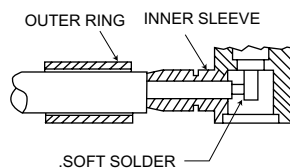

Straight Coaxial

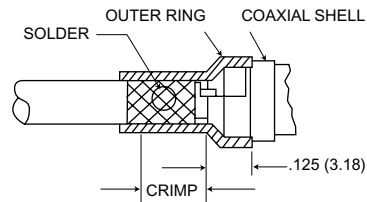
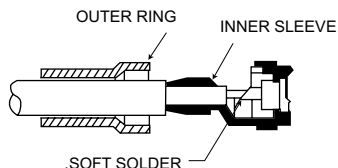

STEP 1: Straight and 90° Coaxials

Slide the outer ring over the cable jacket. Trim the cable as specified in the table of Coax Cable Trim Dimensions. Insert the cable dielectric and center conductor into the inside diameter of the inner sleeve. Then solder the center conductor to the coax center contact.

STEP 2: Straight and 90° Coaxials

Slide the outer ring forward until it is flush with the coax shell containing the braid between the outer ring and the inner sleeve. For solder type coaxes, soft solder the outer ring to the assembly through the cross-drilled solder hold. For crimp type coaxes, crimp with the appropriate tool in the area defined.

See *Commerical D Subminiature* catalog for additional Combo D options, including 75 ohm Coax.

Combo D® - Coaxial/50 Ohm

Right Angle Receptacle for PCB Mounting



PCB Layouts - Page 352

Military part numbers come complete with fixed, female, signal and coaxial contacts and right angle brackets.

Military part numbers come with coaxial contacts.

Non-magnetic part numbers must use coaxial contacts from Page 347 and do not come with brackets.

Layout	Military	NM Non-Magnetic
DE-5W1	DEMMP5X1SP	DEM5W1SP-NMB-K52
DA-7W2	DAMMP7X2SP	DAM7W2SP-NMB-K52
DA-11W1	DAMMP11X1SP	DAM11W1SP-NMB-K52
DA-3W3	DAMMP3X3SP	DAM3W3SP-NMB-K47
DB-5W5	DBMMP5X5SP	DBM5W5SP-NMB-K47
DB-9W4	DBMMP9X4SP	DBM9W4SP-NMB-K52
DB-13W3	DBMMP13X3SP	DBM13W3SP-NMB-K52
DB-17W2	DBMMP17X2SP	DBM17W2SP-NMB-K52
DB-21W1	DBMMP21X1SP	DBM21W1SP-NMB-K52
DC-8W8	DCMMP8X8SP	DCM8W8SP-NMB-K47
DC-13W6	DCMMP13X6SP	DCM13W6SP-NMB-K52
DC-17W5	DCMMP17X5SP	DCM17W5SP-NMB-K52
DC-21WA4	DCMMP21XA4SP	DCM21WA4SP-NMB-K52
DC-25W3	DCMMP25X3SP	DCM25W3SP-NMB-K52
DC-27W2	DCMMP27X2SP	DCM27W2SP-NMB-K52

Dimensions

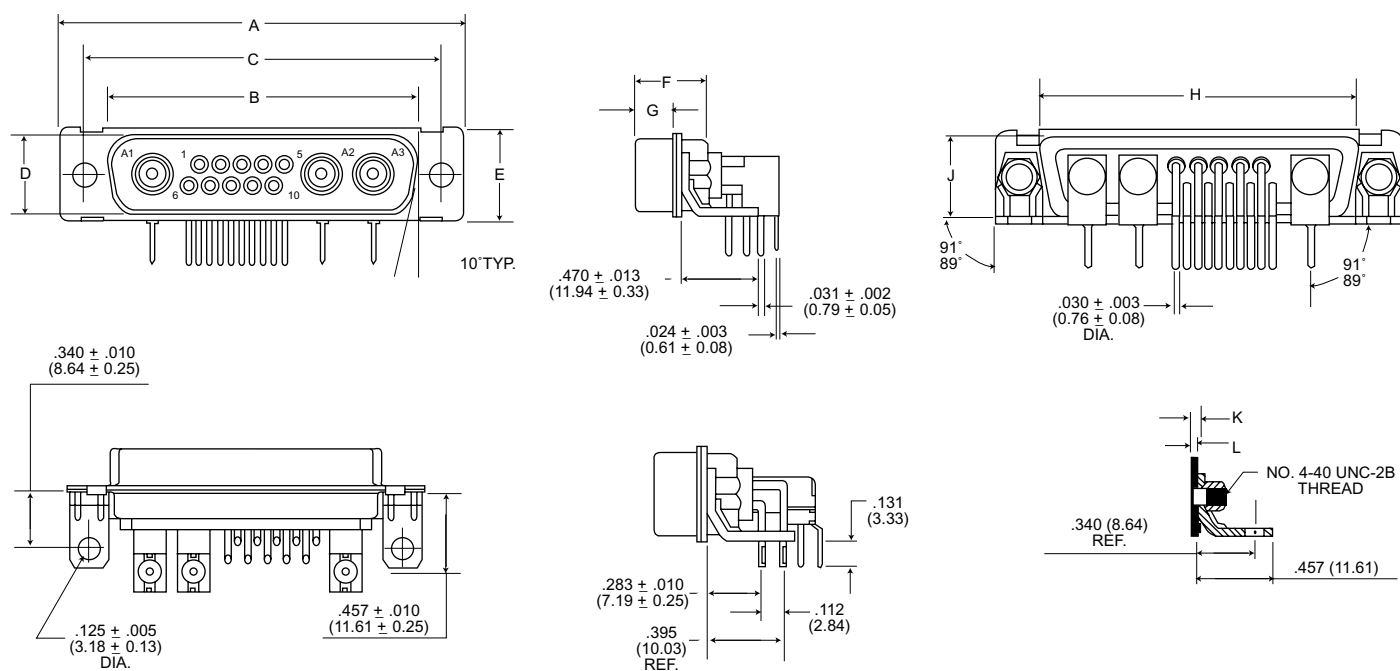

SOCKET CONNECTOR ASSEMBLY (Female)

Shell Size	A ± .015 (0.38)	B ± .005 (0.13)	C ± .005 (0.13)	D ± .005 (0.13)	E ± .015 (0.38)	F ± .005 (0.13)	G ± .005 (0.13)	H ± .010 (0.25)	J ± .010 (0.25)	K ± .013 (0.33)	L ± .010 (0.25)
DE	1.213 (30.81)	.643 (16.33)	.984 (24.99)	.311 (7.90)	.494 (12.55)	.429 (10.90)	.243 (6.17)	.759 (19.28)	.422 (10.72)	.048 (1.22)	.030 (0.76)
DA	1.541 (39.14)	.971 (24.66)	1.312 (33.32)	.311 (7.90)	.494 (12.55)	.429 (10.90)	.243 (6.17)	1.083 (27.51)	.422 (10.72)	.048 (1.22)	.030 (0.76)
DB	2.088 (53.03)	1.511 (38.38)	1.852 (47.04)	.311 (7.90)	.494 (12.55)	.429 (10.90)	.243 (6.17)	1.625 (41.27)	.422 (10.72)	.048 (1.22)	.039 (0.99)
DC	2.729 (69.31)	2.159 (54.84)	2.500 (63.50)	.311 (7.90)	.494 (12.55)	.429 (10.90)	.243 (6.17)	2.272 (57.71)	.422 (10.72)	.048 (1.22)	.039 (0.99)

See *Commerical D Subminiature* catalog for additional Combo D options, including 75 ohm Coax.

Combo D® - Coaxial/50 Ohm

Right Angle Plug for PCB Mounting



PCB Layouts - Page 352

Military part numbers come complete with fixed, female, signal and right angle brackets.

Military part numbers come with coaxial contacts.

Non-magnetic part numbers must use coaxial contacts from Page 347 and do not come with brackets.

Layout	Military	NM Non-Magnetic
DE-5W1	DEMMP5X1PP	DEM5W1PP-NMB-K52
DA-7W2	DAMMP7X2PP	DAM7W2PP-NMB-K52
DA-11W1	DAMM11X1PP	DAM11W1PP-NMB-K52
DA-3W3	DAMM3X3PP	DAM3W3P-NMB-K47
DB-5W5	DBMM5X5PP	DBM5W5P-NMB-K47
DB-9W4	DBMM9X4PP	DBM9W4PP-NMB-K52
DB-13W3	DBMM13X3PP	DBM13W3PP-NMB-K52
DB-17W2	DBMM17X2PP	DBM17W2PP-NMB-K52
DB-21W1	DBMM21X1PP	DBM21W1PP-NMB-K52
DC-8W8	DCMM8X8PP	DCM8W8P-NMB-K47
DC-13W6	DCMM13X6PP	DCM13W6PP-NMB-K52
DC-17W5	DCMM17X5PP	DCM17W5PP-NMB-K52
DC-21WA4	DCMM21XA4PP	DCM21WA4PP-NMB-K52
DC-25W3	DCMM25X3PP	DCM25W3PP-NMB-K52
DC-27W2	DCMM27X2PP	DCM27W2PP-NMB-K52

Dimensions

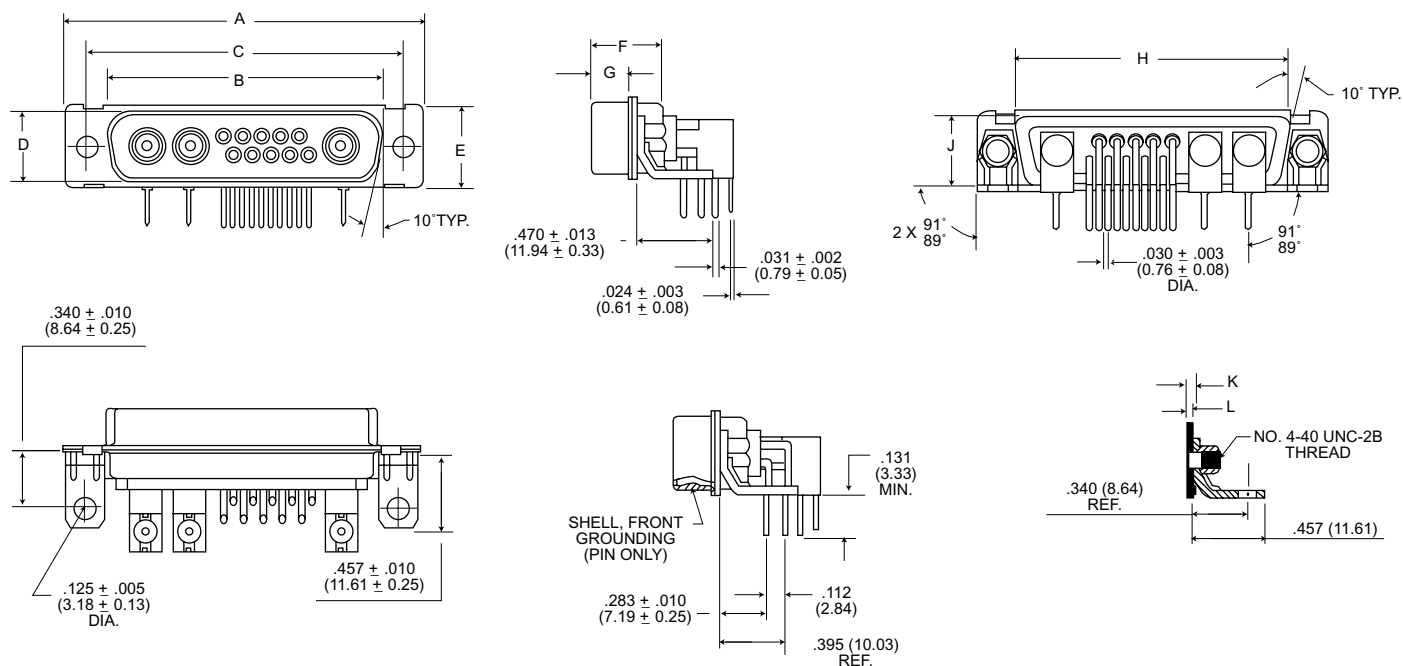

PLUG CONNECTOR ASSEMBLY (Male)

Shell Size	A + .015 (0.38)	B + .005 (0.13)	C + .005 (0.13)	D + .005 (0.13)	E + .015 (0.38)	F + .005 (0.13)	G + .006 (0.15)	H + .010 (0.25)	J + .010 (0.25)	K + .013 (0.33)	L + .010 (0.25)
DE	1.213 (30.81)	.666 (16.91)	.984 (24.99)	.329 (8.36)	.494 (12.55)	.422 (10.72)	.236 (5.99)	.759 (19.28)	.422 (10.72)	.048 (1.22)	.030 (0.76)
DA	1.541 (39.14)	.994 (25.24)	1.312 (33.32)	.329 (8.36)	.494 (12.55)	.422 (10.72)	.236 (5.99)	1.083 (27.51)	.422 (10.72)	.048 (1.22)	.030 (0.76)
DB	2.088 (53.03)	1.534 (38.96)	1.852 (47.04)	.329 (8.36)	.494 (12.55)	.426 (10.82)	.231 (5.87)	1.625 (41.27)	.422 (10.72)	.060 (1.52)	.039 (0.99)
DC	2.729 (69.31)	2.182 (55.42)	2.500 (63.50)	.329 (8.36)	.494 (12.55)	.426 (10.82)	.231 (5.87)	2.272 (57.71)	.422 (10.72)	.060 (1.52)	.039 (0.99)

See *Commerical D Subminiature* catalog for additional Combo D options, including 75 ohm Coax.

Combo D® - Coaxial

Right Angle Printed Circuit Board Hole Patterns

Face view, pin insert
(for receptacle, hole pattern is a mirror image)

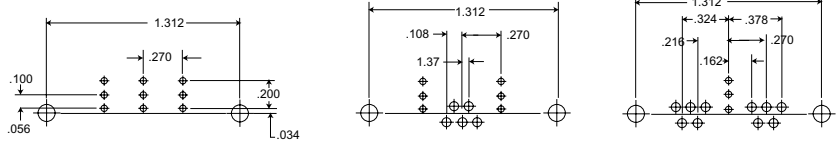
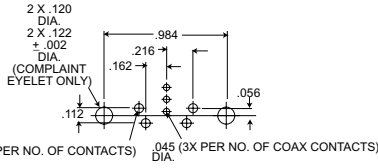

Shell Size **E**
Contact Arrangement **5W1**
No. of Signal Contacts **4 #20**
No. of Coaxial Contacts **1**

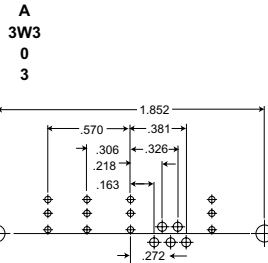
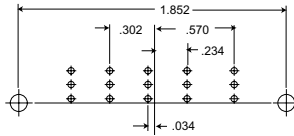

Shell Size **A**
Contact Arrangement **7W2**
No. of Signal Contacts **5 #20**
No. of Coaxial Contacts **2**

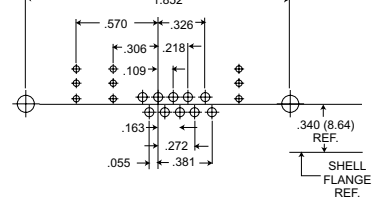

Shell Size **A**
Contact Arrangement **11W1**
No. of Signal Contacts **10 #20**
No. of Coaxial Contacts **1**

Shell Size **B**
Contact Arrangement **5W5**
No. of Signal Contacts **0**
No. of Coaxial Contacts **5**

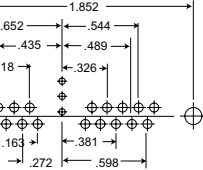
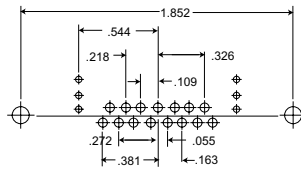

Shell Size **B**
Contact Arrangement **9W4**
No. of Signal Contacts **5 #20**
No. of Coaxial Contacts **4**

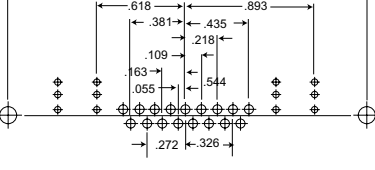

Shell Size **B**
Contact Arrangement **17W2**
No. of Signal Contacts **15 #20**
No. of Coaxial Contacts **2**

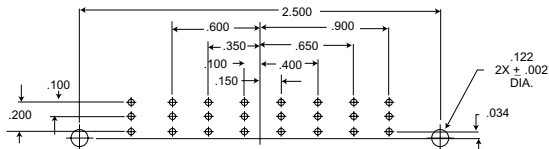

Shell Size **B**
Contact Arrangement **21W1**
No. of Signal Contacts **20 #20**
No. of Coaxial Contacts **1**

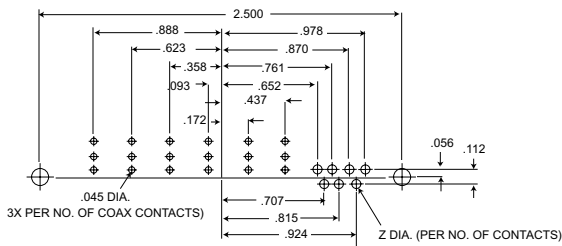

Shell Size **C**
Contact Arrangement **21WA4**
No. of Signal Contacts **17 #20**
No. of Coaxial Contacts **4**

Shell Size **C**
Contact Arrangement **8W8**
No. of Signal Contacts **0**
No. of Coaxial Contacts **8**

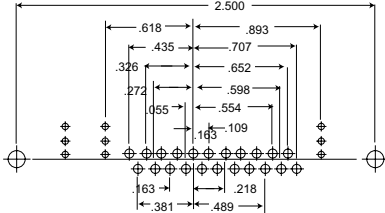
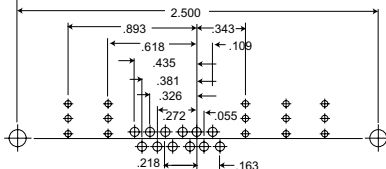

Shell Size **C**
Contact Arrangement **13W6**
No. of Signal Contacts **7 #20**
No. of Coaxial Contacts **6**

Shell Size **C**
Contact Arrangement **17W5**
No. of Signal Contacts **12 #20**
No. of Coaxial Contacts **5**

Shell Size **C**
Contact Arrangement **25W3**
No. of Signal Contacts **22 #20**
No. of Coaxial Contacts **3**

Size #20 Contact PC Tail Dia.	Z Dia.
.030 (0.76)	.045 (1.14)

See *Commerical D Subminiature* catalog for additional Combo D options, including 75 ohm Coax.

Combo D® - Coaxial/50 Ohm

Straight Receptacle for PCB Mounting



PCB Hole Patterns - Pages 354-355

Part numbers come complete with fixed, female, signal and coaxial contacts.

Layout	Military	NM Non-Magnetic
DE-5W1	DEMM5X1SM	DEM5X1SM-NM-K52
DA-7W2	DAMM7X2SM	DAM7X2SM-NM-K52
DA-11W1	DAMM11X1SM	DAM11X1SM-NM-K52
DA-3W3	DAMM3X3SM	DAM3X3SM-NM-K52
DB-5W5	DBMM5X5SM	DBM5X5SM-NM-K52
DB-9W4	DBMM9X4SM	DBM9X4SM-NM-K52
DB-13W3	DBMM13X3SM	DBM13X3SM-NM-K52
DB-17W2	DBMM17X2SM	DBM17X2SM-NM-K52
DB-21W1	DBMM21X1SM	DBM21X1SM-NM-K52
DC-8W8	DCMM8X8SM	DCM8X8SM-NM-K52
DC-13W6	DCMM13X6SM	DCM13X6SM-NM-K52
DC-17W5	DCMM17X5SM	DCM17X5SM-NM-K52
DC-21WA4	DCMM21XA4SM	DCM21XA4SM-NM-K52
DC-25W3	DCMM25X3SM	DCM25X3SM-NM-K52
DD-24W7	DCMM24X7SM	DCM24X7SM-NM-K52
DC-27W2	DCMM27X2SM	DCM27X2SM-NM-K52
DD-24W7	DDMM24X7SM	DDM24X7SM-NM-K52
DD-36W4	DDMM36X4SM	DDM36X4SM-NM-K52
DD-43W2	DDMM43X2SM	DDM43X2SM-NM-K52
DD-47W1	DDMM47X1SM	DDMC47X1SM-NM-K52

Straight Plug for PCB Mounting (Board Thickness up to .125 [3.18])



PCB Hole Patterns - Pages 354-355

Part numbers come complete with fixed, male, signal and coaxial contacts.

Layout	Military	NM Non-Magnetic
DE-5W1	DEMM5X1PM	DEM5X1PM-NM-K52
DA-7W2	DAMM7X2PM	DAM7X2PM-NM-K52
DA-11W1	DAMM11X1PM	DAM11X1PM-NM-K52
DA-3W3	DAMM3X3PM	DAM3X3PM-NM-K52
DB-5W5	DBMM5X5PM	DBM5X5PM-NM-K52
DB-9W4	DBMM9X4PM	DBM9X4PM-NM-K52
DB-13W3	DBMM13X3PM	DBM13X3PM-NM-K52
DB-17W2	DBMM17X2PM	DBM17X2PM-NM-K52
DB-21W1	DBMM21X1PM	DBM21X1PM-NM-K52
DC-8W8	DCMM8X8PM	DCM8X8PM-NM-K52
DC-13W6	DCMM13X6PM	DCM13X6PM-NM-K52
DC-17W5	DCMM17X5PM	DCM17X5PM-NM-K52
DC-21WA4	DCMM21XA4PM	DCM21XA4PM-NM-K52
DC-25W3	DCMM25X3PM	DCM25X3PM-NM-K52
DC-27W2	DCMM27X2PM	DCM27X2PM-NM-K52
DD-24W7	DDMM24X7PM	DDM24X7PM-NM-K52
DD-36W4	DDMM36X4PM	DDM36X4PM-NM-K52
DD-43W2	DDMM43X2PM	DDM43X2PM-NM-K52
DD-47W1	DDMM47X1PM	DDM47X1PM-NM-K52

Dimensions

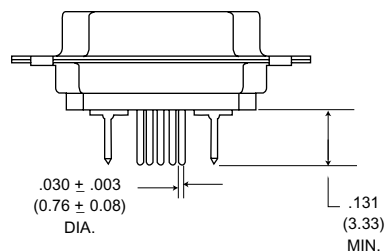

See *Commerical D Subminiature* catalog for additional Combo D options, including 75 ohm Coax.

Combo D® - Coaxial

Straight Printed Circuit Board Hole Patterns

Face view, pin insert
(for receptacle, hole pattern is a mirror image)

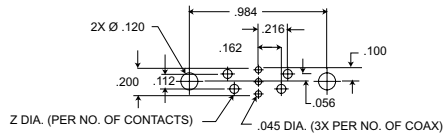

Shell Size **E**
Contact Arrangement **5W1**
No. of Signal Contacts **4 #20**
No. of PC Coaxial Contacts **1**

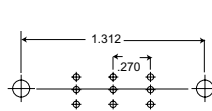

Shell Size **A**
Contact Arrangement **3W3**
No. of Signal Contacts **-**
No. of PC Coaxial Contacts **3**

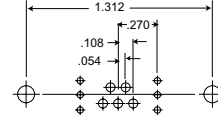

Shell Size **A**
Contact Arrangement **7W2**
No. of Signal Contacts **5 #20**
No. of PC Coaxial Contacts **2**

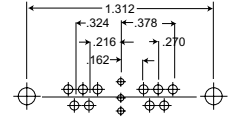

Shell Size **A**
Contact Arrangement **11W1**
No. of Signal Contacts **10 #20**
No. of PC Coaxial Contacts **1**

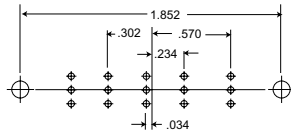

Shell Size **B**
Contact Arrangement **5W5**
No. of Signal Contacts **-**
No. of PC Coaxial Contacts **5**

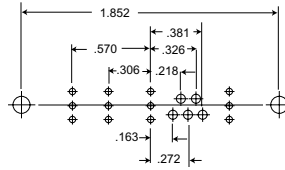

Shell Size **B**
Contact Arrangement **9W4**
No. of Signal Contacts **5 #20**
No. of PC Coaxial Contacts **4**

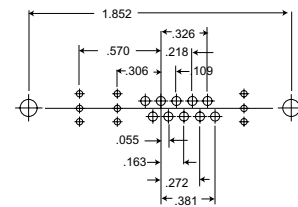

Shell Size **B**
Contact Arrangement **13W3**
No. of Signal Contacts **10 #20**
No. of PC Coaxial Contacts **3**

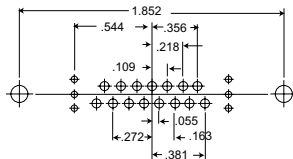

Shell Size **B**
Contact Arrangement **17W2**
No. of Signal Contacts **15 #20**
No. of PC Coaxial Contacts **2**

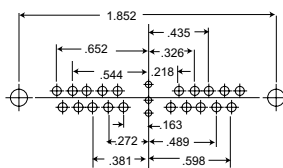

Shell Size **B**
Contact Arrangement **21W1**
No. of Signal Contacts **20 #20**
No. of PC Coaxial Contacts **1**

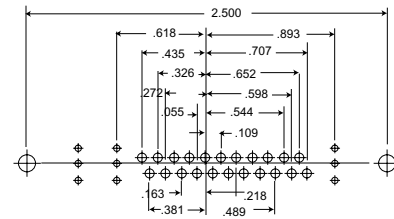

Shell Size **C**
Contact Arrangement **25W3**
No. of Signal Contacts **22 #20**
No. of PC Coaxial Contacts **3**

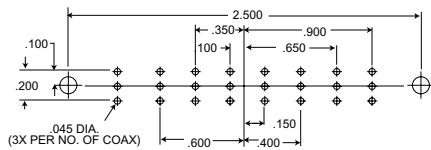

Shell Size **C**
Contact Arrangement **8W8**
No. of Signal Contacts **-**
No. of PC Coaxial Contacts **8**

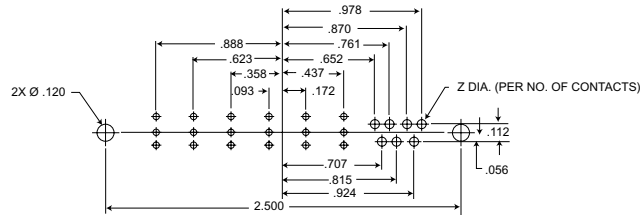

Shell Size **C**
Contact Arrangement **13W6**
No. of Signal Contacts **7 #20**
No. of PC Coaxial Contacts **6**

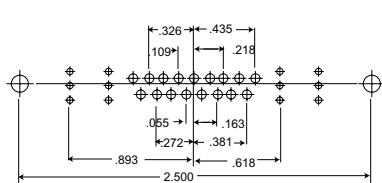

Shell Size **C**
Contact Arrangement **21WA4**
No. of Signal Contacts **17 #20**
No. of PC Coaxial Contacts **4**

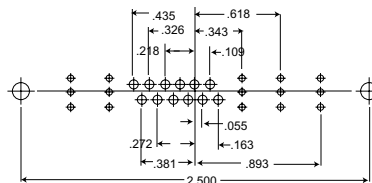

Shell Size **C**
Contact Arrangement **17W5**
No. of Signal Contacts **12 #20**
No. of PC Coaxial Contacts **5**

Size No. 20	2
Contact PC	
Tail Dia.	Dia.
.030 (0.76)	.045 (1.14)

Combo D® - Coaxial

Straight Printed Circuit Board Hole Patterns

Face view, pin insert
(for receptacle, hole pattern is a mirror image)

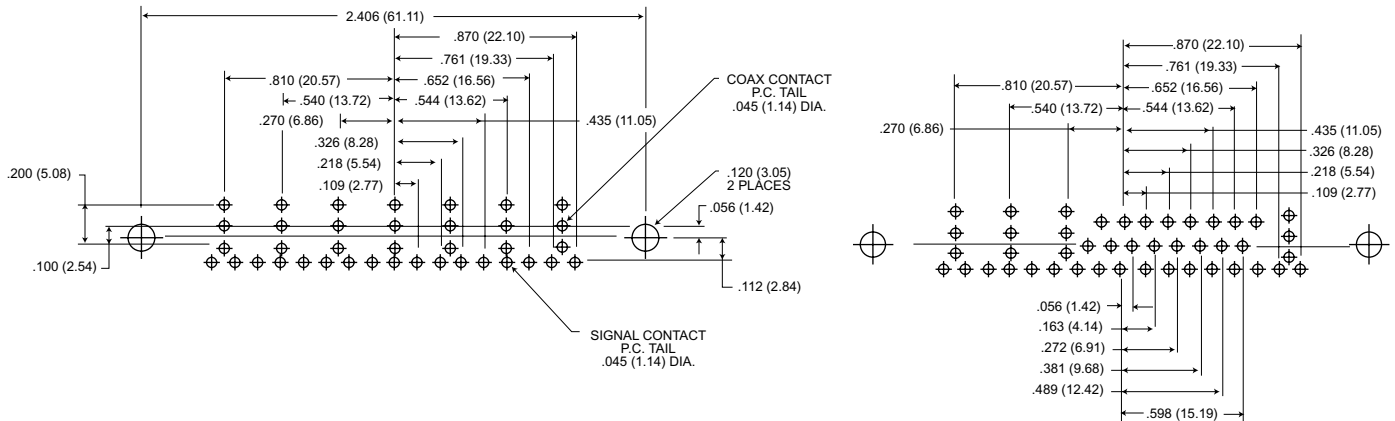

Shell Size **D**
 Contact Arrangement **24W7**
 No. of Signal Contacts **17 #20**
 No. of Coaxial Contacts **7**

Shell Size **D**
 Contact Arrangement **36W4**
 No. of Signal Contacts **32 #20**
 No. of Coaxial Contacts **4**

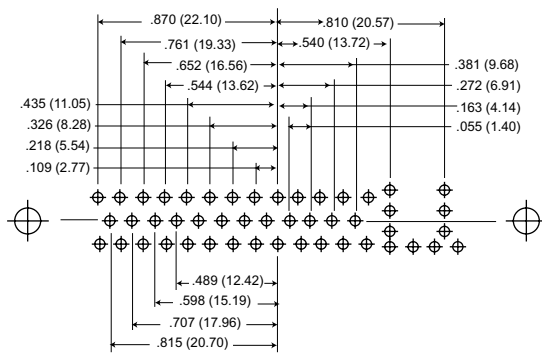

Shell Size **D**
 Contact Arrangement **43W2**
 No. of Signal Contacts **41 #20**
 No. of Coaxial Contacts **2**

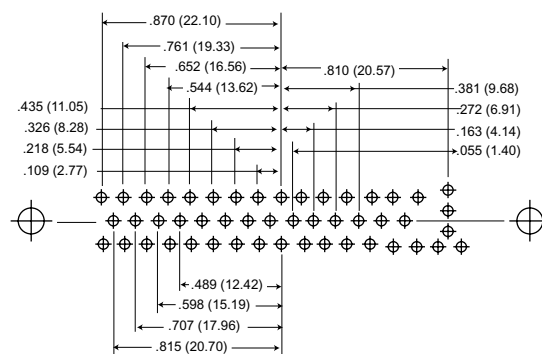

Shell Size **D**
 Contact Arrangement **47W1**
 No. of Signal Contacts **46 #20**
 No. of Coaxial Contacts **1**

Combo D® - High Voltage

Coaxial Housings With Solder Cup Signal Contacts

High voltage contacts supplied separately.



Contact Arrangements: Page 346 of Coax section
Performance Specifications: Page 345 of Coax section.

Clinch Nut and Float Mount Options Available:

Add: E = 4-40 Clinch Nut
Y = Float Mounting

Example: DAMME3W3P
DAMMY3W3P

See page 334 for Mounting Method Detail.

Cable Combinations supplied with preloaded solder signal contacts. High Power Contacts supplied separately, see below.

Extraction Tool for High Power Contacts are the same as for 50 Ohm Coaxial Contacts. See page 348.

Layout	Military Socket	Military Pin	NM - Non-Magnetic Socket	NM - Non-Magnetic Pin
DE-5W1	DEM5W1S	DEM5W1P	DEM5W1S-NMB-K52	DEM5W1P-NMB-K52
DA-7W2	DAMM7W2S	DAMM7W2P	DAM7W2S-NMB-K52	DAM7W2P-NMB-K52
DA-11W1	DAMM11W1S	DAMM11W1P	DAM11W1S-NMB-K52	DAM11W1P-NMB-K52
DA-3W3	DAMM3W3S	DAMM3W3P	DAM3W3S-NMB-K47	DAM3W3P-NMB-K47
DB-5W5	DBMM5W5S	DBMM5W5P	DBM5W5S-NMB-K47	DBM5W5P-NMB-K47
DB-9W4	DBMM9W4S	DBMM9W4P	DBM9W4S-NMB-K52	DBM9W4P-NMB-K52
DB-13W3	DBMM13W3S	DBMM13W3P	DBM13W3S-NMB-K52	DBM13W3P-NMB-K52
DB-17W2	DBMM17W2S	DBMM17W2P	DBM17W2S-NMB-K52	DBM17W2P-NMB-K52
DB-21W1	DBMM21W1S	DBMM21W1P	DBM21W1S-NMB-K52	DBM21W1P-NMB-K52
DC-8W8	DCMM8W8S	DCMM8W8P	DCM8W8S-NMB-K47	DCM8W8P-NMB-K47
DC-13W6	DCMM13W6S	DCMM13W6P	DCM13W6S-NMB-K52	DCM13W6P-NMB-K52
DC-17W5	DCMM17W5S	DCMM17W5P	DCM17W5S-NMB-K52	DCM17W5P-NMB-K52
DC-21WA4	DCMM21WA4S	DCMM21WA4P	DCM21WA4S-NMB-K52	DCM21WA4P-NMB-K52
DC-25W3	DCMM25W3S	DCMM25W3P	DCM25W3S-NMB-K52	DCM25W3P-NMB-K52
DC-27W2	DCMM27W2S	DCMM27W2P	DCM27W2S-NMB-K52	DCM27W2P-NMB-K52
DD-24W7	DDMM24W7S	DDMM24W7P	DDM24W7S-NMB-K52	DDM24W7P-NMB-K52
DD-36W4	DDMM36W4S	DDMM36W4P	DDM36W4S-NMB-K52	DDM36W4P-NMB-K52
DD-43W2	DDMM43W2S	DDMM43W2P	DDM43W2S-NMB-K52	DDM43W2P-NMB-K52
DD-47W1	DDMM47W1S	DDMM47W1P	DDM47W1S-NMB-K52	DDM47W1P-NMB-K52

High Power Contacts

Solder Type

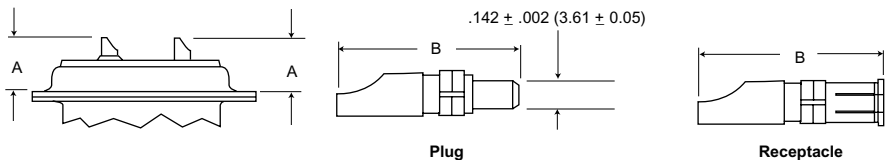

	Gold over Nickel	50µ in. Gold over Copper	NM - Non-Magnetic 50µ in. Gold over Copper	A Max.	B Ref.	Current Rating (Amps)	Wire Size
Plug	DM53745-1	DM53745-28	DM53745-70	.666 (16.92)	.866 (22.00)	40	#8
Plug	DM53745-7	DM53745-27	DM53745-77	.666 (16.92)	.866 (22.00)	20	#12
Plug	DM53745-8	DM53745-25	DM53745-70	.666 (16.92)	.866 (22.00)	10	#16
Receptacle	DM53744-1	DM53744-21	DM53744-62	.666 (16.92)	.856 (21.74)	40	#8
Receptacle	DM53744-6	DM53744-25	DM53744-64	.666 (16.92)	.856 (21.74)	20	#12
Receptacle	DM53744-7	DM53744-24	DM53744-63	.666 (16.92)	.856 (21.74)	10	#16

Crimp Type

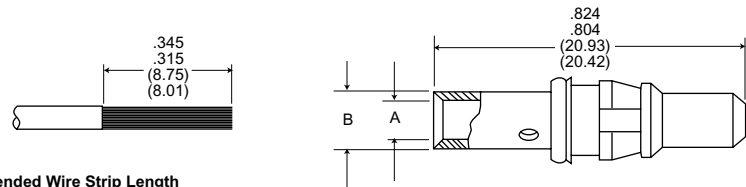

Recommended Wire Strip Length

	Gold over Nickel	50µ in. Gold over Copper	A Dia. Max.	B Dia. Max.	Current Rating (Amps)	Wire Size
Plug	DM130338-4	DM130338	.181 (4.60)	.230 (5.84)	40	#8
Plug	DM130339-4	DN130339	.100 (2.54)	.218 (5.54)	20	#12
Plug	DM130340-4	DM130340	.067 (1.07)	.102 (2.59)	10	#16
Receptacle	DM130341-4	DM130341	.181 (4.60)	.230 (5.84)	40	#8
Receptacle	DM130342-4	DM130342	.100 (2.54)	.218 (5.54)	20	#12
Receptacle	DM130343-4	DM130343	.067 (1.07)	.102 (2.59)	10	#16

Crimp Tooling - Page 357.

See Commercial D Subminiature catalog for PCB High Power connectors.

Combo D® - High Power

Crimp High Power Contact Tooling

(For use with Crimp High Power Contacts on Page 356)

AWG Wire Size	Daniels Crimp Tool	Crimp Tool/Locator	
		Tool Setting Number	Locator
8-10	M300-BT	AWG 8 = 6 AWG 10 = 5	TP968
12-14	M300-BT	AWG 12/14 = 1	TP968
16-18	FT-8	AWG 16 = 6 AWG 18 = 5	TH554

NOTE: Purchase tooling directly from Daniels.

Combo D Guide Pin and Socket

Installs into any Combo D, size 8 Cavity. This patented guide pin and socket system is ideal for blind mate applications where space is limited.

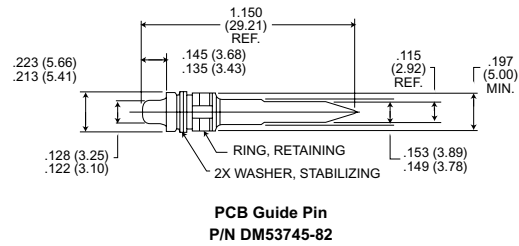
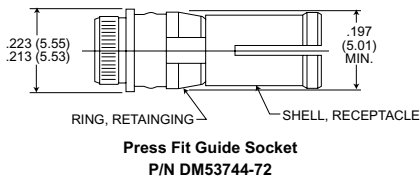

Description	Material	Finish
Guide Pin	Brass	Gold over nickel
Guide Socket	Copper Alloy	Gold over nickel

Combo D® - High Voltage

Coaxial Housings With Solder Cup Signal Contacts

High voltage contacts supplied separately.



Contact Arrangements: Page 346 of Coax section
Performance Specifications: Page 345 of Coax section.

Clinch Nut and Float Mount Options Available:

Add: E = 4-40 Clinch Nut
Y = Float Mounting

Example: DAMME3W3P
DAMMY3W3P

Mouting Method Detail - Page 334.

Cable Combinations supplied with preloaded solder signal contacts. High Voltage Contacts supplied separately, see below.

Extraction Tool for High Voltage Contacts are the same as for 50 Ohm Coaxial Contacts. See page 348.

Layout	Military Socket	Military Pin
DE-5W1	DEMM5W1S	DEMM5W1P
DA-7W2	DAMM7W2S	DAMM7W2P
DA-11W1	DAMM11W1S	DAMM11W1P
DA-3W3	DAMM3W3S	DAMM3W3P
DB-5W5	DBMM5W5S	DBMM5W5P
DB-9W4	DBMM9W4S	DBMM9W4P
DB-13W3	DBMM13W3S	DBMM13W3P
DB-17W2	DBMM17W2S	DBMM17W2P
DB-21W1	DBMM21W1S	DBMM21W1P
DC-8W8	DCMM8W8S	DCMM8W8P
DC-13W6	DCMM13W6S	DCMM13W6P
DC-17W5	DCMM17W5S	DCMM17W5P
DC-21WA4	DCMM21WA4S	DCMM21WA4P
DC-25W3	DCMM25W3S	DCMM25W3P
DC-27W2	DCMM27W2S	DCMM27W2P
DD-24W7	DCMM24W7S	DCMM24W7P
DD-36W4	DCMM36W4S	DCMM36W4P
DD-43W2	DCMM43W2S	DCMM43W2P
DD-47W1	DCMM47W1S	DCMM47W1P

High Voltage Combination Contacts

Wire Accommodation (AWG)	#20 Max.
Current Rating	5 Amp
Temperature Rating	-55°C to +125°C

Description	Material	Finish
Contacts	Copper Alloy	Std: Gold over nickel MIL-50μ in. Gold over copper
Insulator	Thermoplastic	None
Ring, Retaining	Copper Alloy	Nickel

Straight

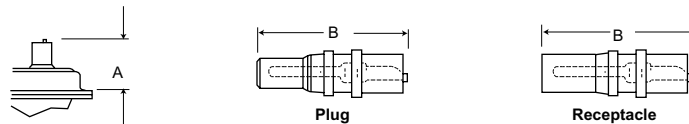

	Gold over Nickel	50μ in. Gold	A Max.	B Ref.	Wire Size
Plug	DM51157	DM51157-8	.539 (13.69)	.734 (18.64)	#20
Receptacle	DM51155	DM51155-7	.539 (13.69)	.764 (19.41)	#20

Right Angle

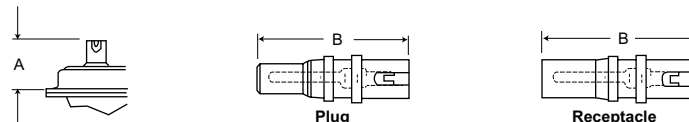

	Gold over Nickel	50μ in. Gold	A Max.	B Ref.	Wire Size
Plug	DM51157-5000	DM51157-5005	.491 (12.47)	.697 (17.70)	#20
Receptacle	DM51155-5000	DM51155-5004	.491 (12.47)	.697 (17.70)	#20

Straight PCB

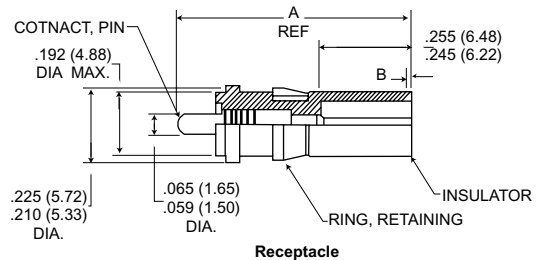
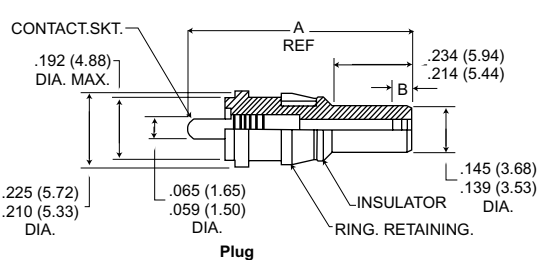

	Standard Finish	Military Finish	A	B
Plug	DM51157-13	DM51157-14	.628 (15.95)	.060/.050 (1.52/1.27)
Receptacle	DM51155-12	DM51155-13	.660 (16.76)	.010/.000 (0.25/0.00)

RAPID RESPONSE FAX FORM

COPY THIS PAGE AND FAX TO (03) 9850 6793

Name _____ Date _____
 Title _____
 Company Name _____
 Company Address _____
 City _____ State _____ ZIP _____ Country _____
 Telephone _____ FAX _____
 E-mail Address _____
 Your Application _____

Please Quote the following:

Quantity	Part Number

Comments & Special Needs:

Do you need an Assembly? Fill in relevant lengths and cable specifications.

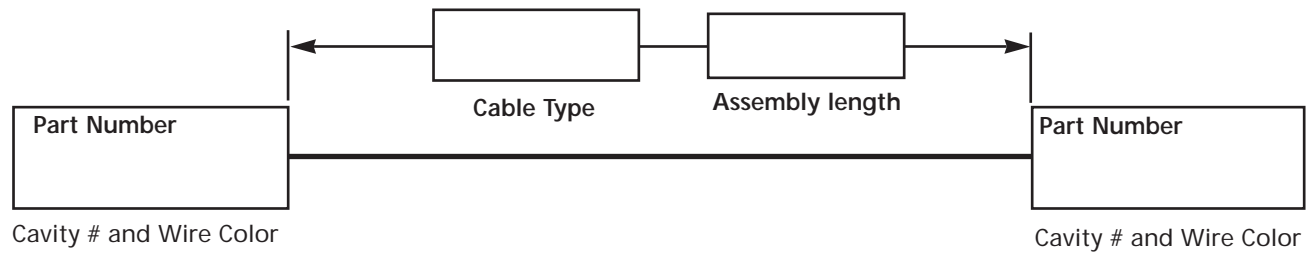

- Please call me to discuss my needs.
- Contact me about electrical wire and cable.
- I also need other harsh environment connectors or accessories.
- Please send additional copies of the catalog to:

Cambridge Technologies

www.cambridge-tec.com

(03) 9850 6099 FAX: (03) 9850 6793
 21 Bridge Street, Bulleen, Victoria 3105