

MSM6052-70GS/71RS/11RS

TONE/PULSE SWITCHABLE REPERTORY DIALER

GENERAL DESCRIPTION

The MSM6052-70GS, MSM6052-71RS and MSM6052-11RS are Tone/Pulse switchable repertory dialer which are fabricated by OKI's low power consumption CMOS silicon gate technology. All of these LSIs can generate either DTMF (Dual Tone Multi Frequency) signal or DP (Dial Pulse) signal.

The repertory memory has a capacity of 500 digits. Maximum 54* telephone numbers of 32 digits maximum per telephone number can be stored in it, so far as the total number of stored digits does not exceed 500 digits.

All of these LSIs operate on 2.5 V ~ 6.0 V single supply voltage. Stand-by current is 0.2 μ A maximum and the memory retention voltage is 1.2 V.

FEATURES

- Either DTMF signal or DP signal generation.
- 500 digits repertory memory (54* numbers maximum, 32 digits maximum/number).
- 24 telephone numbers which can be recalled by single key operation and additional 30* telephone numbers which can be recalled by 2-digits abbreviated code.
- Mixed dialing, Mixed storing (Repertory memory can be stored as a part of another repertory memory).
- Last number redial (32 digits maximum)
- Auto insertion of 4 seconds access pause.
- Pulse rate 10/20 pps pin selectable.
- Make/Break ratio 34/66 or 40/60 pin selectable.
- Alarm tone for wrong operations.
- 3.58 MHz for ceramic resonator oscillation circuit on-chip.
- Supply voltage range 2.5 V ~ 6 V.
- Low stand-by current 0.2 μ A maximum.

	MSM6052-70GS	MSM6052-71RS	MSM6052-11RS
Memory Storing/ Clearing	Both of On-Hook memory storing/clearing and Off-Hook memory storing/clearing or On-Hook memory storing/clearing only selectable		On-Hook memory storing/clearing only
Keyboard Interface	Matrix keyboard input or 4-bit parallel data input selectable		Matrix keyboard input
Package	44 pin plastic FLAT package	40 pin plastic DIP package	28 pin plastic DIP package

* In case of MSM6052-70GS and MSM6052-71RS, "Senbl" pin has to be set at "H" level to enable 30 numbers stored into 2-digits abbreviated code.

PIN CONFIGURATION

MSM6052-70GS

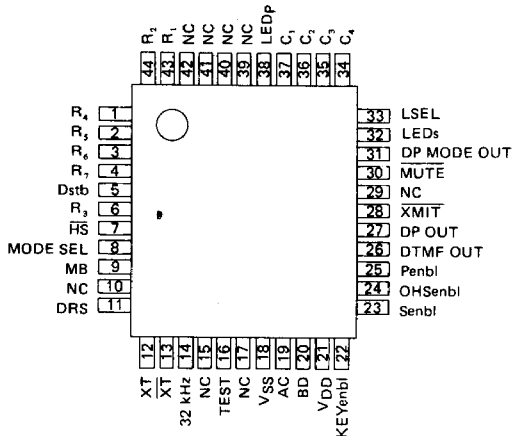

MSM6052-71RS

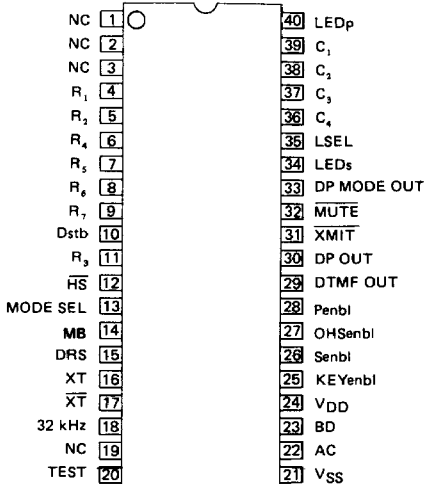

MSM6052-11RS

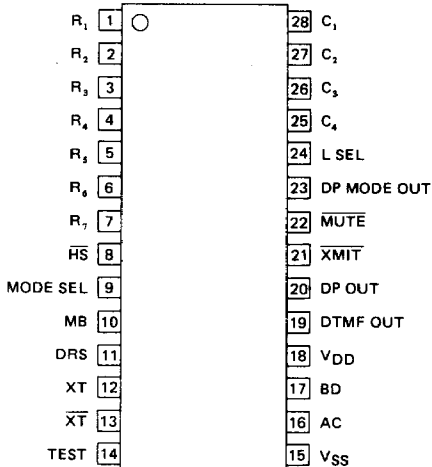

Note: The NC pin must not be connected.

KEYBOARD INTERFACE

Both of MSM6052-70GS and MSM6052-71RS have an option to choose either keyboard input or 4-bit parallel data input. This option is selected by the status of KEYenbl pin.

As for MSM6052-11RS, data is only input from the keyboard. The interface of MSM6052-70GS and MSM6052-71RS with the keyboard and 4-bit parallel data input is described in the Figure 1, while the interface of MSM6052-11RS with the keyboard is described in the Figure 2.

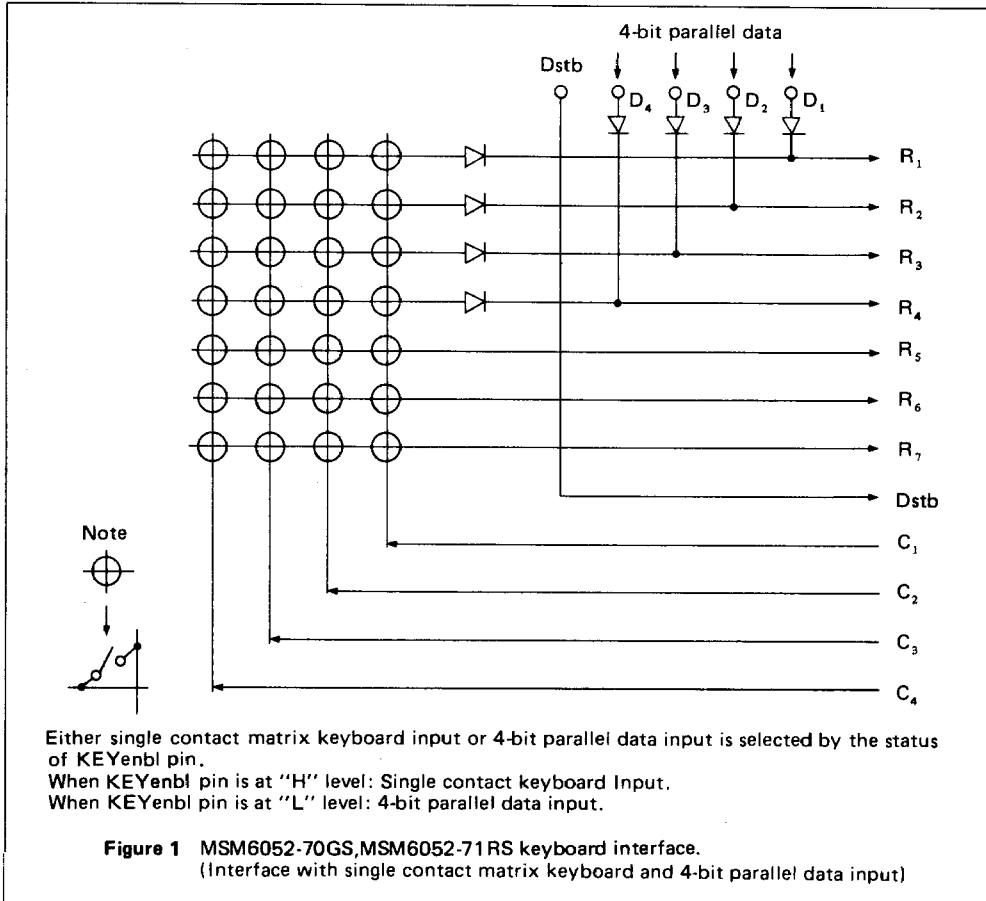

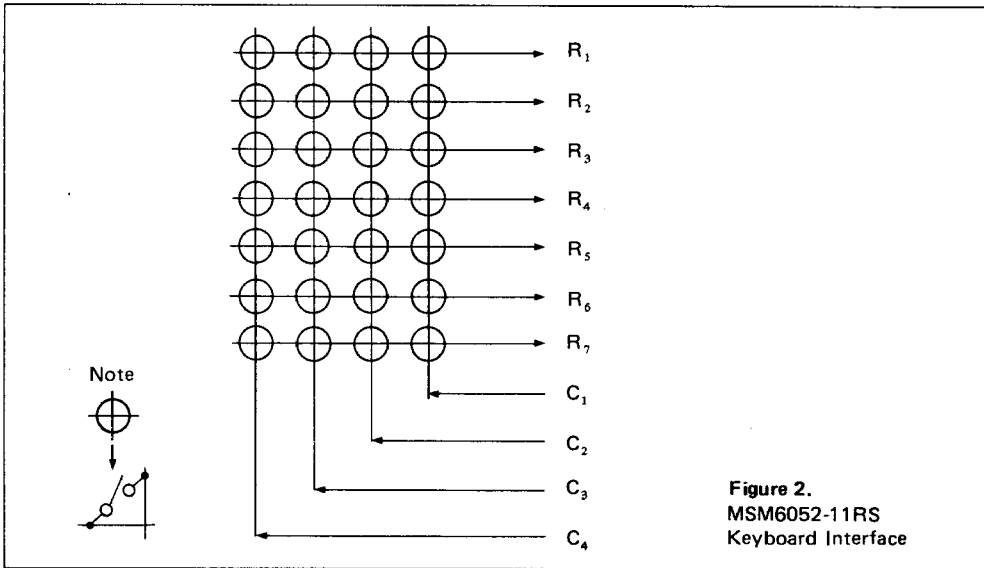

Interface with a single contact matrix keyboard

Output pin Input pin	C1	C2	C3	C4
R1	1	2	3	RECALL
R2	4	5	6	STORE
R3	7	8	9	PAUSE/REDIAL
R4	∗	0	#	tone
R5	L1/L13	L2/L14	L3/L15	L4/L16
R6	L5/L17	L6/L18	L7/L19	L8/L20
R7	L9/L21	L10/L22	L11/L23	L12/L24

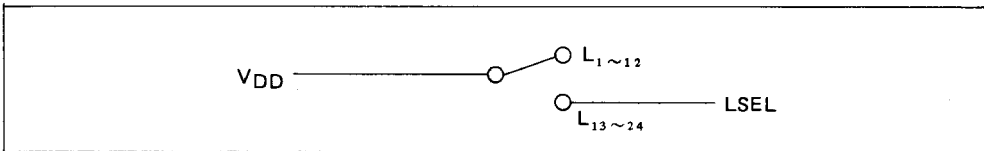

A 7 x 4 matrix single contact keyboard shall be used. L1/L13 ~ L12/L24 are single key dialing keys. By connecting or disconnecting LSEL to/from VDD, two telephone numbers can be assigned for each key.

So, the 24 numbers in total can be recalled by single key operation. *In addition to it, maximum 30 numbers can be abbreviated into 2-digit address code (00 ~ 29).

*In this case, Senbl pin of MSM6052-70GS and MSM6052-71RS shall be set to "H" level.

4-bit parallel data input (Only MSM6052-70GS and MSM6052-71RS)

When 4-bit parallel data input is selected by setting KEYenbl pin at "L" level, operation is executed by 4-bit data and strobe signals.

In this case, however, dialing by single key recall operation cannot be used.

Figure 3 shows a 4-bit parallel data input timing, while Figure 4 shows the 4-bit data and its corresponding data input from the keyboard.

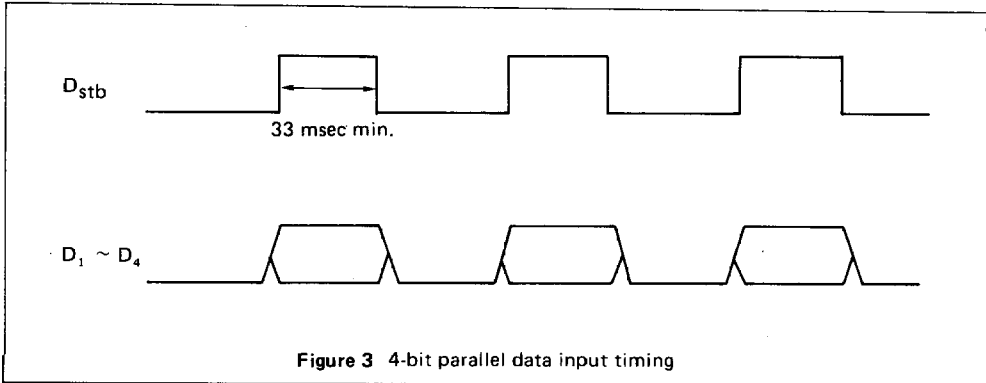

HEX Data	0	1	2	3	4	5	6	7	8	9	A	B	C	D	E	F	
KEY Data	STORE	1	2	3	4	5	6	7	8	9	0	*	#	TONE	REDIAL	PAUSE	RECALL

Note: C₁ ~ C₄ shall be set at "L" level when OFF-Hooked in the stand-by mode. Oscillation will stop when key input or 4-bit parallel data input is stopped.

Figure 4 4-bit parallel data and its corresponding key data

PIN DESCRIPTION

Pin Name	Pin No.			Function
	-70	-71	-11	
R ₁ ~R ₇	1~4, 6, 43, 44	4~9, 11,	1~7,	Key input pins. As for MSM6052-11RS, C ₁ ~C ₄ are set to low level in on-hook mode, while they are set to high level in off-hook standby mode. As for MSM6052-70GS and MSM6052-71RS, the C ₁ ~C ₄ conditions are as follows. Keyboard input: On-hook mode: Low Off-hook stand-by mode: High 4-bit parallel data input: Constantly low
C ₁ ~C ₄	34~37	36~39	25~28	
Dstb	5	10	—	(Only MSM6052-70GS and MSM6052-71RS) When 4-bit parallel data input is selected, the data strobe signal is input to this pin.
\overline{HS}	7	12	8	Hook switch input pin. \overline{HS} = "H" level or open : On-hook \overline{HS} = "L" level : Off-hook
LSEL	33	35	24	Selection pin for single key dialing. LSEL = "L" or open : L ₁ ~ L ₁₂ LSEL = "H" : L ₁₃ ~ L ₂₄
MB	9	14	10	Make/Break ratio selection pin. MB = "L" or open : 40/60% MB = "H" : 34/66% Note: This input is sensed during the transition stage from On-hook to Off-hook.
DRS	11	15	11	Dial rate selection pin. DRS = "L" or open : 10 pps DRS = "H" : 20 pps Note: This input is sensed in the transition stage from On-hook to Off-hook.
MODE SEL	8	13	9	DTMF/DP mode selection pin. MODE SEL = "L" or open : DP mode MODE SEL = "H" : DTMF mode If TONE key is pressed in the DP mode, the DFMF mode is established. Note: This input is sensed in the transition stage from On-hook to Off-hook.
DTMF OUT	26	29	19	DTMF output pin.

Pin Name	Pin No.			Function
	-70	-71	-11	
DP OUT	27	30	20	Dial pulse output pin. This pin is at "H" level for "Make", and at "L" level for "Break". A "L" level output is also obtained when \overline{HS} = "H" or open (On-hook).
\overline{XMIT}	28	31	21	Transmitter mute output pin. When \overline{HS} = "H" or open (On-hook) : \overline{XMIT} = "L" When \overline{HS} = "L" (Off-hook) i. While DP signal or DTMF signal is being output : \overline{XMIT} = "L" ii. All other times : \overline{XMIT} = "H"
\overline{MUTE}	30	32	22	Mute output pin. When \overline{HS} = "H" or open (On-hook) : \overline{MUTE} = "L" When \overline{HS} = "L" (Off-hook) i. While DP signal is being output : \overline{MUTE} = "L" ii. All other times : \overline{MUTE} = "H"
DP MODE OUT	31	33	23	Dial pulse mode output pin. When \overline{HS} status is changed from "H" or (On-hook) to "L" (Off-hook), either "H" level or "L" level signal is output from this pin by following conditions. MODE SEL = "L" or open: DP MODE OUT = "H" level output MODE SEL = "H": DP MODE OUT = "L" level output A "L" level signal is output from DP MODE OUT pin even when MODE SEL = "L" and \overline{HS} = "L", if $\overline{[TONE]}$ key is pressed.
XT, \overline{XT}	12, 13	16, 17	12, 13	Ceramic resonator connection pin. Since MSM6052 is provided with an on-chip oscillation inverter and feed-back resistor, a 3.58 MHz ceramic resonator and capacitors are to be connected to XT and \overline{XT} .
AC	19	22	16	Internal initialization pin. When this IC is powered on, a reset signal ("H" level). has to be applied to this pin.
V_{DD} , V_{SS}	21,18	24,21	18,15	V_{DD} : Positive power supply pin (2.5 V ~ 6.0 V) V_{SS} : Negative power supply pin (Ground)
TEST	16	20	14	Test pin. This pin should be left open.
BD	20	23	17	Buzzer output pin.

Pin Name	Pin No.			Function
	-70	-71	-11	
KEYenbl	22	25	—	(Only MSM6052-70GS and MSM6052-71RS) Either matrix keyboard input or 4-bit parallel data input is selected according to the status of this pin. KEYenbl = "H" : matrix keyboard input operation. KEYenbl = "L" : 4-bit parallel data input
OHSenbl	24	27	—	(Only MSM6052-70GS and MSM6052-71RS) Memory storage method is determined by the status of this pin. OHSenbl = "H" : Both of On-hook memory storing and Off-hook memory storing are possible. OHSenbl = "L" : Only On-hook memory storing is possible.
Senbl	23	26	—	(Only MSM6052-70GS and MSM6052-71RS) Memory storing into 2-digits abbreviated code is enabled/disabled by the status of this pin. Senbl = "H" : Memory storage into 2-digits abbreviated code is enabled. Senbl = "L" : Memory storage into 2-digits abbreviated code is disabled.
Penbl	25	28	—	(Only MSM6052-70GS and MSM6052-71RS) Manual pause cancel function is enabled/disabled by the status of this pin. Penbl = "H" : Manual pause cancel function is enabled. Penbl = "L" : Manual pause cancel function is disabled. When manual pause cancel function is disabled, PAUSE key is only used to establish the pause.
LEDs	32	34	—	(Only MSM6052-70GS and MSM6052-71RS) A "H" level signal is output during the memory store/clear operation. All other times, a "L" level signal is output.
LEDp	38	40	—	(Only MSM6052-70GS and MSM6052-71RS) A "H" level signal is output when a pause is established, while an "L" level signal is output at all other times.
32 kHz	14	18	—	(Only MSM6052-70GS and MSM6052-71RS) Output terminal of 32 kHz lock.

FUNCTIONAL DESCRIPTION

Dialing Function

(1) Normal Dialing

Off-Hook $\boxed{D_1} \boxed{D_2} \boxed{D_3} \dots \boxed{D_n}$
 ($\boxed{D_n}$ designates for $\boxed{0} \sim \boxed{9}$, $\boxed{\times}$, $\boxed{\#}$, $\boxed{P/R}$ or $\boxed{\text{TONE}}$ keys)
 * $\boxed{P/R}$: $\boxed{\text{PAUSE/REDIAL}}$

The maximum number of digits which can be dialed out at a time in the DP mode is 32 digits. Any additional digit is dialed out only after the first 32 digits are dialed out.

Before the first 32-digits are dialed out, any key input from the keyboard is inhibited.

If more than 32-digits are dialed out either in DTMF or DP mode, redialing of that number is disabled.

Note: In the DP mode, $\boxed{\times}$ and $\boxed{\#}$ key inputs are invalid.

(2) Redialing

Off-Hook $\boxed{P/R}$

When $\boxed{P/R}$ key is firstly pressed once after the telephone is On-hooked, the last dialed-out telephone number is dialed out.

$\boxed{P/R}$: $\boxed{\text{PAUSE/REDIAL}}$

If the redial function is inhibited, an alarm tone is generated and normal dialing can be executed after that.

(3) Repertory Dialing

Off-Hook $\boxed{R} \boxed{A_1} \boxed{A_2} \dots$ 2-digits abbreviated code dialing
 or

Off-Hook $\boxed{L_n} \dots$ Single key dialing

\boxed{R} : $\boxed{\text{RECALL}}$

$\boxed{L_n}$: $\boxed{L_1/L_{12}} \sim \boxed{L_{13}/L_{24}}$

$\boxed{A_1}$: $\boxed{0}$, $\boxed{1}$, $\boxed{2}$

$\boxed{A_2}$: $\boxed{0} \sim \boxed{9}$

In case of 2-digits abbreviated code dialing, an alarm tone is generated if any key other than $\boxed{0}$, $\boxed{1}$ or $\boxed{2}$ key is pressed after \boxed{R} key.

In this case, however, if \boxed{R} key is pressed again after the alarm tone, 2-digits abbreviated code is addressed after \boxed{R} key, and the memory contents of that 2-digits abbreviated code will be dialed out. In this case, if any key other than \boxed{R} key is firstly pressed after the alarm tone, an alarm tone will be generated again.

An alarm tone is also generated if the specified repertory memory has no contents, or if another repertory has been specified within the selected repertory.

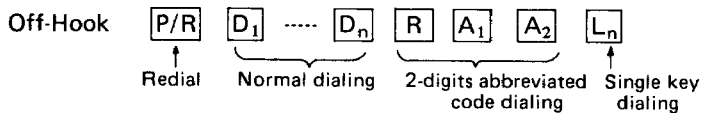
(4) Mixed Dialing

Consecutive dialing of redialing, normal dialing, 2-digits abbreviated code dialing and single key dialing is possible. In case of mixed dialing, however, redialing of the last dialed number can be executed only once and it must come to the first part of the mixed dialing.

If the digits of the mixed dialed number do not exceed 32, that mixed dialed number can be redialed. (In this case, both of 2-digits abbreviated code memory contents and single key memory contents are counted as 3-digits. The digits of the redialing, however, depends on the contents of the redialing.)

(5) Pause

When the **PAUSE** key is pressed, transmission of DTMF/DP signal will temporarily be suspended after that digit. This pause is automatically released 4 seconds later. In addition to this automatic pause releasing, manual pause cancelling by pressing the **PAUSE** key during the 4-seconds pause is available for MSM6052-11RS. As for MSM6052-70GS and MSM6052-71RS, this manual pause cancelling function is enabled/disabled by the status of Penbl pin. (Refer to the Note below.)

By this manual pause canceling function by pressing **PAUSE** key during the 4-seconds pause, multi digits pause can also be cancelled by a single pause cancel operation.

Note: As for MSM70GS and MSM6052-71RS-10RS, the status of Penbl pin enables/disables the manual pause cancel function.

Penbl = "H" : Pause can be manually cancelled by pressing **PAUSE** key.

Penbl = "L" : Pause cannot be cancelled manually.

(6) Switching to DTMF mode

When **TONE** key is pressed in the DP mode, the mode is switched to DTMF mode from that digit.

When **TONE** key is pressed during the DP signal is being transmitted out, a pause will automatically be inserted after the transmission of DP signal has been completed. DTMF mode is established and signals are transmitted after this pause has been released.

This pause can also be cancelled manually. (Refer to (5) Pause.)

(7) Key input confirmation tone

As for MSM6052-11RS, an operation confirmation tone is generated for the input by **0** ~ **9**, **RECALL**, **STORE**, **PAUSE/REDIAL** and **TONE** keys in the DP mode and input by **RECALL**, **STORE**, **PAUSE/REDIAL** and **TONE** keys in the DTMF mode.

As for MSM6052-70GS and MSM6052-71RS, no operation confirmation tone is generated for the input by these keys. An operation confirmation tone, however, will be generated for memory storing/clearing operation.

Memory Storing/Clearing Function

As for MSM6052-70GS and MSM6052-71RS, two different types of memory storing/clearing operations are available and these are determined by the status of OHSenbl pin.

As for MSM6052-11RS, only On-Hook memory storing/clearing is available.

MSM6052-70GS	MSM6052-71RS	
OHSenbl pin = "H" level: Memory storing/clearing is possible both in On-Hook and *Off-Hook condition		Only On-Hook condition
OHSenbl pin = "L" level: Only On-Hook condition		

Memory storing/clearing operation condition

- * When Off-Hook memory storing/clearing is available, memory storing/clearing operation can be done even after the dialing operation.

Memory storing/clearing operation is commenced by pressing **STORE** key and is stopped when any of following conditions is established.

- i. When the memory storing/clearing operation has completed.
- ii. When the interval between any two key inputs exceeds 20 seconds.
- iii. When the number of digits exceeds 32.
- iv. When total number of digits stored in the memory exceeds 500.

An alarm tone is generated for above iii. and iv.

A key input confirmation tone is generated for all key inputs.

(1) Storing of telephone number

Memory storing operation can be done by following operations.

S **D**₁ **D**₂ **D**_n **S** **A**₁ **A**₂ Store into 2-digits abbreviated code address

S **D**₁ **D**₂ **D**_n **S** **L**_n Store into single key address

S : **STORE**

In case of storing telephone number into 2-digits abbreviated code address, **A**₁ shall be any of **0**, **1** or **2** and **A**₂ shall be any of **0** ~ **9**. For any input other than these keys, an alarm tone is generated.

In this case, however, by pressing **STORE** key again enables to select the 2-digits abbreviated code address again.

If any key other than **STORE** key is pressed, an alarm tone is generated.

If the empty space of the repertory memory is less than 16 digits, an alarm tone is generated at the first **STORE** key input. In other words, if an alarm is not generated at the first **STORE** key input, minimum 16 digits can be newly stored.

An alarm tone is generated at the 500th digit input showing the memory has no more capacity. That 500th input digit can be stored in the memory, however. If the 501st digit is input, an alarm tone is generated again and memory storing operation is cancelled.

Maximum digits of a telephone number to be stored is 32. **[TONE]** key input and pause information by **[PAUSE/REDIAL]** key input are counted as one digit respectively.

If the 33rd digit is input, an alarm sound is generated and memory storing operation is cancelled.

24 telephone numbers can be abbreviated to single key dialing address, which are **[L₁]** ~ **[L₂₄]**. Other than those single key dialing address, maximum 30 telephone numbers can be abbreviated to *2-digit address codes, which are **[00]** ~ **[29]**, so far as total stored digits in the repertory memory do not exceed 500.

* In this case, Sembl pin of MSM6052-70GS and MSM6052-71RS has to be set to "H" level.

(2) Mixed Storing

[S] **[P/R]** **[D₁]** **[D₂]** **[D_n]** **[R]** **[A₁]** **[A₂]** **[L_n]** **[S]** **[A'₁]** **[A'₂]**

----- Store into 2-digits abbreviated code address

[S] **[P/R]** **[D₁]** **[D₂]** **[D_n]** **[R]** **[A₁]** **[A₂]** **[L_n]** **[S]** **[L_m]**

----- Store into single key address

[P/R] : Last dialed telephone number

[D₁] ~ **[D_n]** : Normal dial

[R] **[A₁]** **[A₂]** : Already stored telephone number

[L_n] : Already stored telephone number

[A'₁] **[A'₂]** : Newly stored address

[L_m] : Newly stored address

The telephone number once stored in the repertory memory can be used as a part of the newly stored telephone number in the form of abbreviated code. The last dialed telephone number can also be used as a part of newly stored telephone number, but in this case the last dialed telephone number should come to the first part of the newly stored telephone number. Otherwise, input by **[PAUSE/REDIAL]** key is regarded as a pause information.

Maximum 32 digits can be mixed stored. Either **[L_n]** or **[RECALL]** **[A₁]** **[A₂]** is counted as 3 digits, while number of the digit of the last dialed out telephone number depends on the contents of redialing.

If **[L_n]** key or **[RECALL]** key is pressed at the 31st or 32nd digit, an alarm sound is generated and storing is disabled.

Abbreviated code used for the newly stored number must not include abbreviated code of the other telephone number.

(3) Clearing of telephone number

----- Clear the 2-digits abbreviated code address

----- Clear the single key address

Pressing key twice followed by or clears the stored number in that address.

(4) Redial Inhibition

Redialing is disabled by one of following conditions has been established.

- i. When more than 32 digits are dialed out in a single dialing operation.
- ii. In the memory storing/clearing operation, is pressed followed by any valid key input.
- iii. When the telephone is On-hooked, key is pressed twice prior to any key.

BUZZER OUTPUT WAVEFORM

Key Input Confirmation Tone

It is output for the following key input.

Operation	MSM6052-70GS	MSM6052-71RS	MSM6052-11RS	
Normal operation	—		DP mode	[0] ~ [9], All Function keys
			DTMF mode	All Function keys
Memory storing/ Clearing operation	Valid key inputs		Valid key inputs	

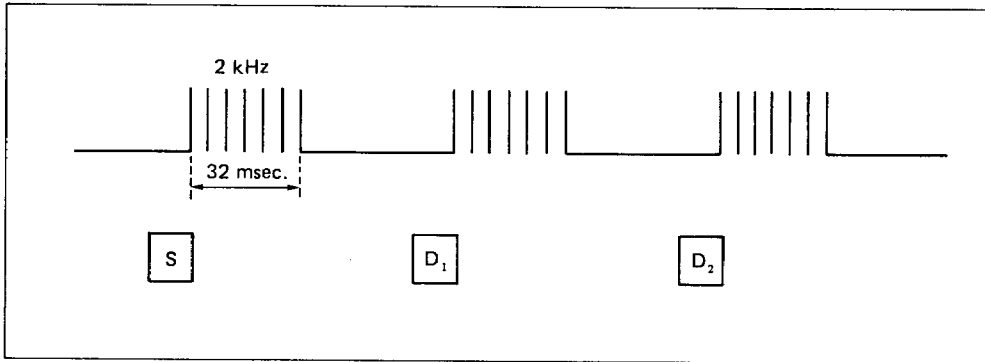

Memory Storing/Clearing Confirmation Tone

It is output when storing/clearing of telephone number has been completed.

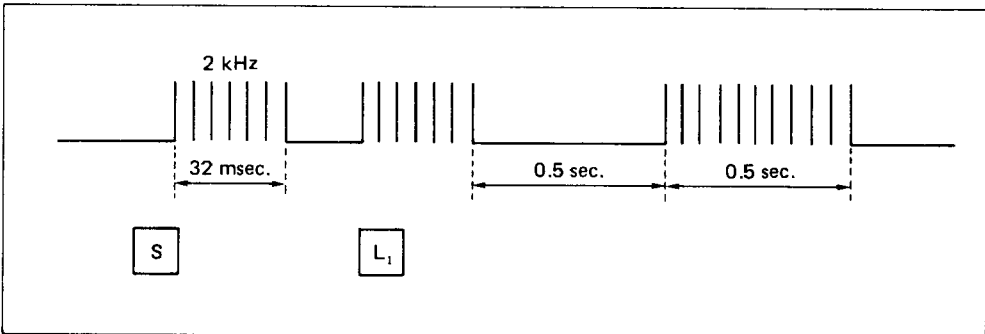

Alarm Sound

- i. It is output for the followings.
 - Wrong key input
 - 33rd digit input for storing
 - **STORE** key input when the empty capacity of repertory memory is less than 16 digits

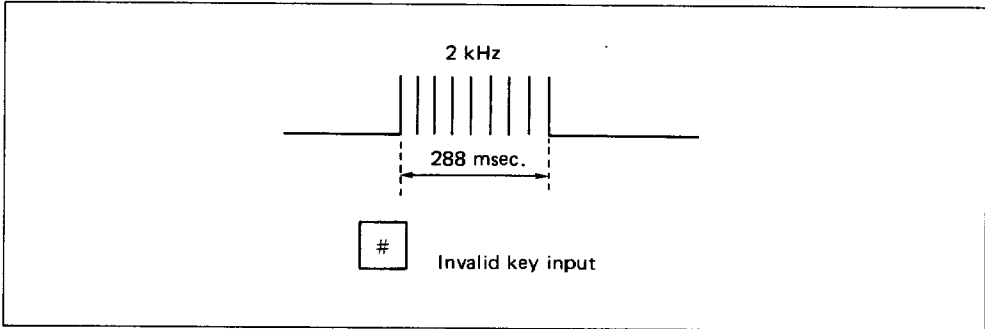

- ii. It is output when the repertory number, using other telephone number's abbreviated code as a part of it, is used as a part of newly stored number.

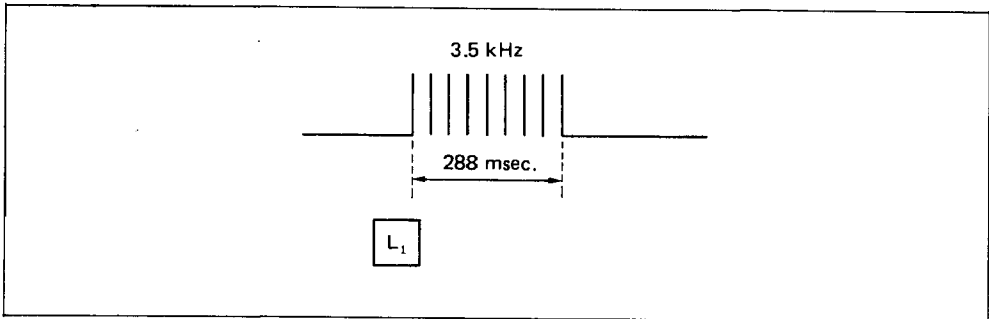

- iii. It is output when there is no data in the accessed memory address. It is also output when redial is prohibited.

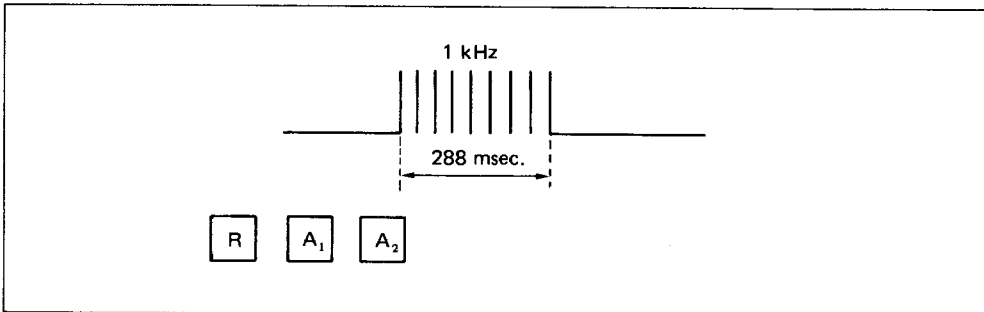

TIMING CHART

DP mode Timing chart

1) Normal dialing

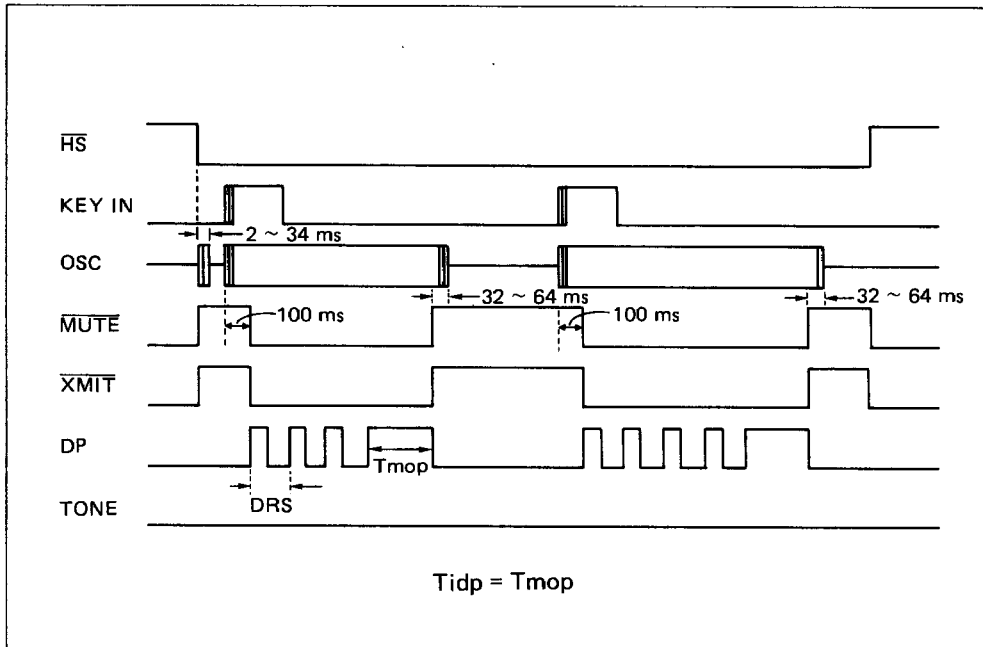

2) Repertory dialing

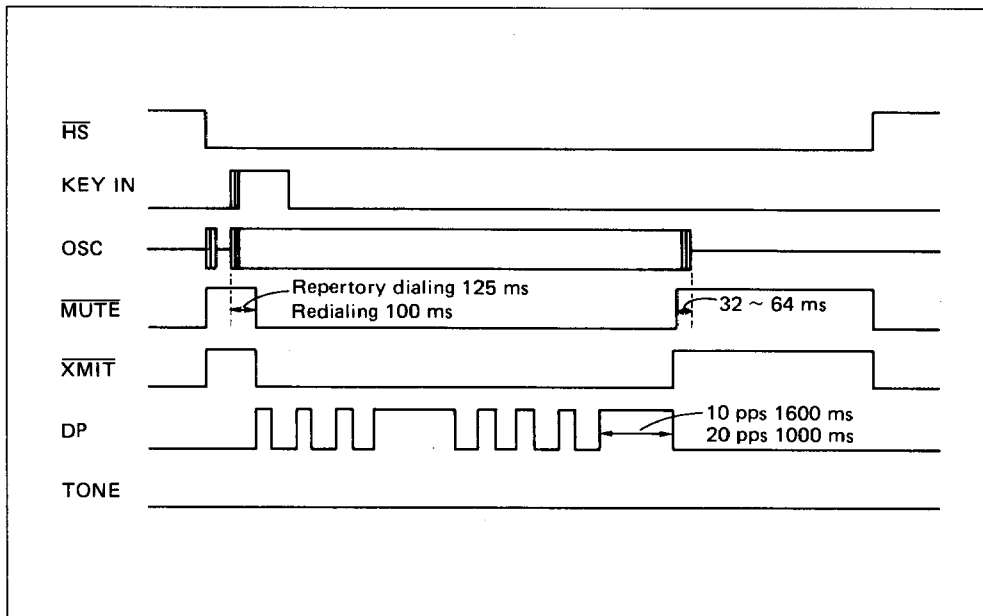

3) Mode change-over by TONE key

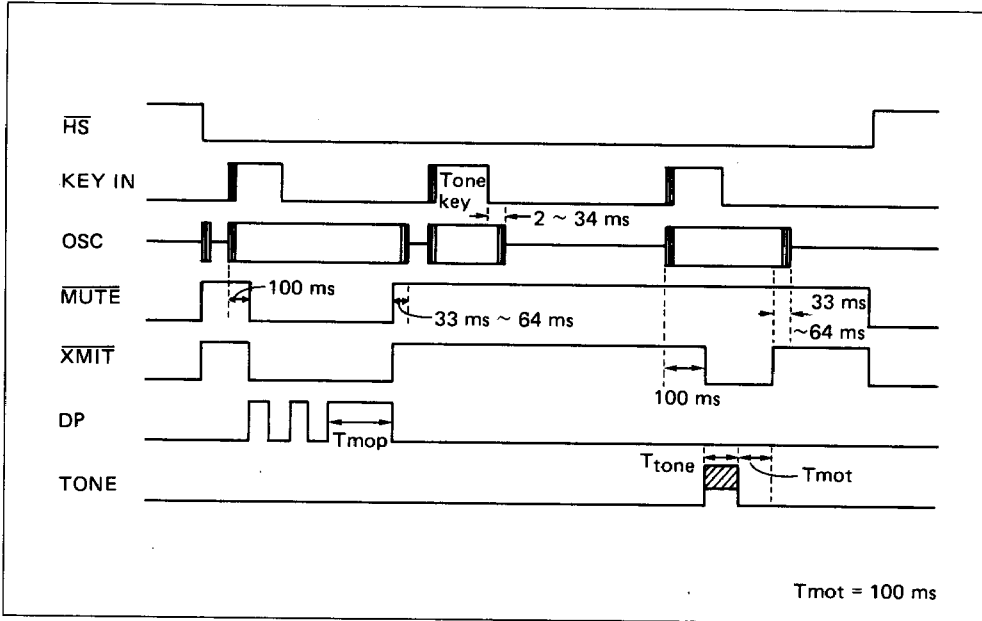

DTMF mode timing chart

1) Normal dialing

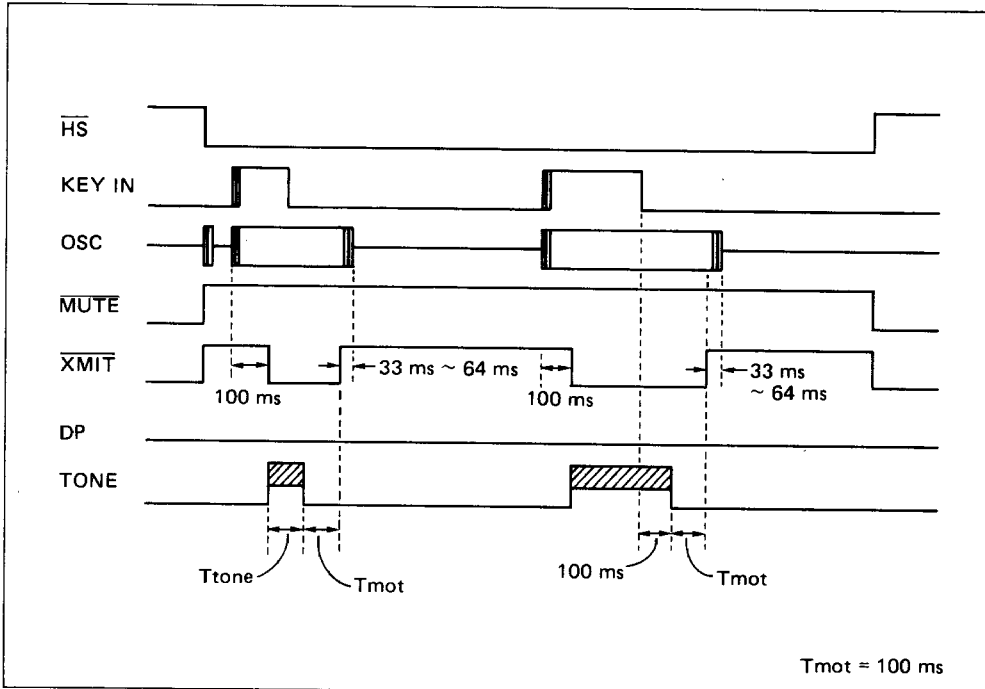

2) Repertory dialing, Redialing

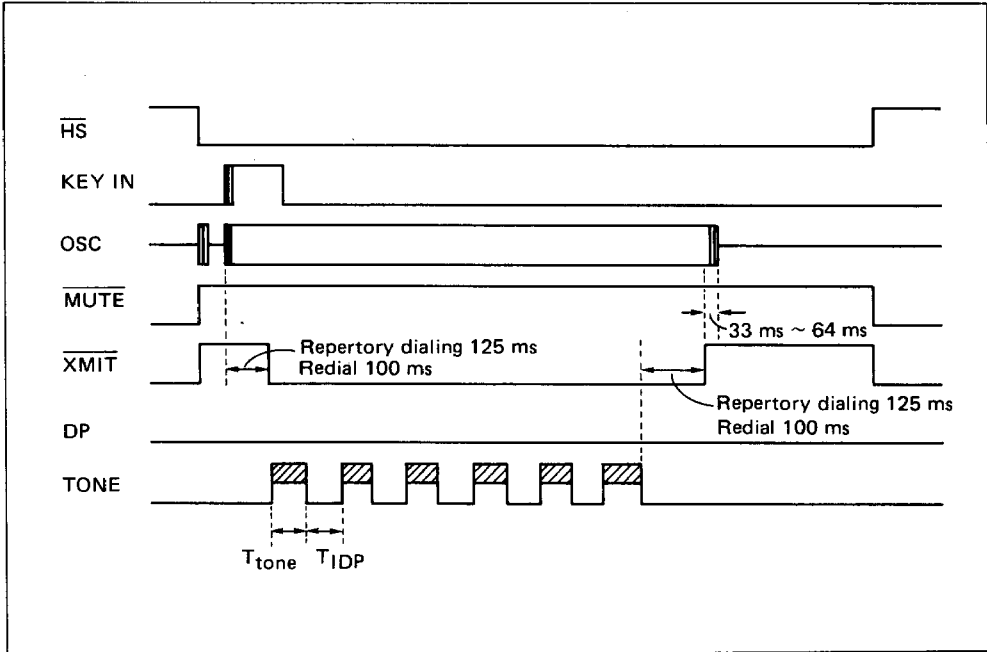

Signal output timing

Parameter	Symbol	Condition	Typical	Unit
Tone Output Time	T tone	Tone auto-dial	100	ms
Inter Digit Pause	Tidp 1	Tone auto-dial	100	ms
	Tidp 2	Pulse auto-dial (10 pps)	800	ms
	Tidp 3	Pulse auto-dial (20 pps)	500	ms

fosc = 3.579545 MHz

ELECTRICAL CHARACTERISTICS

Absolute Maximum Ratings

Parameter	Symbol	Conditions	Ratings	Unit
Supply Voltage	V _{DD}	T _a = 25°C	-0.3 ~ 7	V
Input Voltage	V _I	T _a = 25°C	-0.3 ~ V _{DD} + 0.3	V
Output Voltage	V _O	T _a = 25°C	-0.3 ~ V _{DD} + 0.3	V
Power Dissipation	P _D	T _a = 25°C	200 max	mW
Storage Temperature	T _{stg}	—	-55 ~ +125	°C

Operational Ranges

Parameter	Symbol	Conditions	Ratings	Unit
Operating Voltage	V _{DD}	f _{osc} = 3.58 MHz	2.5 ~ 6	V
Memory Retention Voltage	V _{DDM}	Stand-by mode	1.2 ~ 6	V
Operating Temperature	T _{OP}	—	-20 ~ 75	°C

DC Characteristics

V_{DD} = 3.0 V, V_{SS} = 0 V, f_{OSC} = 3.579545 MHz, T_a = -20 ~ +75°C

Parameter	Symbol	Conditions	V _{DD}	Min	Typ	Max	Unit
"H" Output Current (1)	I _{OH1}	MUTE XMIT DP OUT	V _{OH} = 2.6 V	3.0 V	-0.2	—	mA
"L" Output Current (1)	I _{OL1}		V _{OL} = 0.4 V	3.0 V	0.5	—	mA
"H" Output Current (2)	I _{OH2}	C ₁ ~ C ₄	V _{OH} = 2.6 V	3.0 V	-1.0	—	mA
"L" Output Current (2)	I _{OL2}		V _{OL} = 0.4 V	3.0 V	10	—	μA
"H" Output Current (3)	I _{OL3}	DP MODE OUT LED _s BD	V _{OH} = 2.6 V	3.0 V	-20	—	μA
"L" Output Current (3)	I _{OL3}		V _{OL} = 0.4 V	3.0 V	10	—	μA
"H" Output Current (4)	I _{OH4}	LED _p	V _{OH} = 2.6 V	3.0 V	-150	—	μA
"L" Output Current (4)	I _{OL4}		V _{OL} = 0.4 V	3.0 V	300	—	μA
"H" Output Current (5)	I _{OH5}	32 KHz	V _{OH} = 2.5 V	3.0 V	-40	—	μA
"L" Output Current (5)	I _{OH5}		V _{OL} = 0.4 V	3.0 V	25	—	μA
"H" Input Voltage	V _{IH}	—	3.0 V	2.2	—	—	V
			6.0 V	4.4	—	—	
"L" Input Voltage	V _{IL}	—	3.0 V	—	—	0.8	V
			6.0 V	—	—	1.6	

Parameter	Symbol	Conditions	V _{DD}	Min	Typ	Max	Unit
"H" Input Current (1)	I _{IH1}	HS V _{IH} = 6.0 V	6.0 V	—	—	2	μA
"L" Input Current (1)	I _{IL1}		V _{IL} = 0 V	3.0 V	-20	—	-180
			6.0 V	-40	—	-360	
"H" Input Current (2)	I _{IH2}	R ₁ ~ R ₇ Dstb V _{IH} = 6.0 V	6.0 V	20	—	180	μA
"L" Input Current (2)	I _{IL2}		V _{IH} = 3.0 V	3.0 V	10	—	
			6.0 V	—	—	-2	μA
"H" Input Current (3)	I _{IH3}	MB DRS LSEL MODESEL AC TEST V _{IH} = 6.0 V	6.0 V	60	—	600	μA
"L" Input Current (3)	I _{IL3}		V _{IH} = 3.0 V	3.0 V	30	—	
			6.0 V	—	—	-2	μA
"H" Input Current (4)	I _{IH4}	KEYenbl Senbl OHSenbl Penbl V _{IH} = 6.0 V	6.0 V	—	—	2	μA
"L" Input Current (4)	I _{IL4}		V _{IL} = 0 V	6.0 V	—	—	-2
Current Consumption (1)	I _{DDP}	Pulse mode, No load	3.0 V	—	0.3	0.6	mA
			6.0 V	—	1.2	2.4	
Current Consumption (2)	I _{DDT}	Tone mode, No load	3.0 V	—	1.2	2.4	mA
			6.0 V	—	3.5	7.0	
Memory Retention Current (3)	I _{DDM}	When on-hook mode No load (Ta = 25°C)	2.5 V	—	—	0.2	μA

AC Characteristics

$$f_{OSC} = 3.579545 \text{ MHz}, 2.5 \text{ V} \leq V_{DD} \leq 6.0 \text{ V}, T_a = -20 \sim +75^\circ \text{C}$$

Parameter	Symbol	Conditions	V _{DD}	Min	Typ	Max	Unit
Cycle Time	t _{CY}	f _{osc} = 3.579545 MHz	3.0 V	—	17.9	—	μs
Tone Output	V _{OUT}	ROW side only R _L = 1 kΩ	2.5 V	150	250	350	mV
			4.0 V	200	350	570	
			6.0 V	300	480	850	rms
High/Low Level Ratio	dB _{CR}	—	3.0 V	1	2	3	dB
			6.0 V	1	2	3	
Distortion	% dis	R _L = 1 kΩ	3.0 V	—	1	5	%
			6.0 V	—	1	5	
Key Input Time	T _{KIN}	—	—	33	—	—	ms

DTMF Tone Output Frequency

	Nominal frequency (Hz)	Output frequency (Hz)	Distortion (%)
R ₁	697	699.1	+0.30
R ₂	770	766.2	-0.49
R ₃	852	847.4	-0.54
R ₄	941	948.0	+0.74
C ₁	1209	1215.9	+0.57
C ₂	1336	1331.7	-0.32
C ₃	1477	1471.9	-0.35

 $f_{osc} = 3.579545 \text{ MHz}$