

GC89...F

BAR CLAMP FOR HOCKEY PUK DEVICES

Clamping total thickness of assembly from
29mm to 128mm

Pre-loaded to the specific clamping
force (12 ÷ 24 kN)

Maximum device diameter: 76mm

Surface passivation to provide extra protection

Hexagon head bolt partially

threaded M8x1.25, UNI5737, 8.8 steel

Various lengths of bolts and insulators

Flat clamping head for optimal clamping
force application

Four styles available

User friendly clamping force indicator

UL94 certified insulation material

Parameter	Unit	Types	Testing conditions	Notes	Values			
					Min	Typ	Max	
Weight	g	GC89S...F			590		720	
		GC89B...F			980		1150	
Clamping Force*	kN	GC89...12F				12		
		GC89...16F				16		
		GC89...20F					20	
		GC89...24F					24	
Clamping Force tolerance						± 10%		
Insulation Voltage	V _{RMS}		1 min			3000		
Insulating Material				Noryl ® **				
UL File				E121562				
Max. working temperature	°C				-30		110	
Creepage distance:	mm					28		
Clearance distance:	mm					20.3		
Storage temperature	°C				-40		110	
Flammability	mm			UL94 V-1 Flame class rating		1.5		
	mm			UL94 V-0 Flame class rating		8.00		
	mm			CSA Flammability		1.00		

* Other clamping forces available: contact factory

** Noryl ® is a registered trade mark of General Electric



ORDERING INFORMATION TABLE

Clamps can be ordered using the following part numbering system

GC89	B	N	B	A	20	F	S
(1)	(2)	(3)	(4)	(5)	(6)		

(1) Construction type:	B = with double bar
	S = with single bar
(2) Insulator position:	N = upper side
	R = lower side
(3) Insulator code:	see table below
(4) Bolt code:	see table below
(5) Clamping force (in kN):	12
	16
	20
	24
(6) Special accessories	blank = no accessories
	S = extra bar spacer

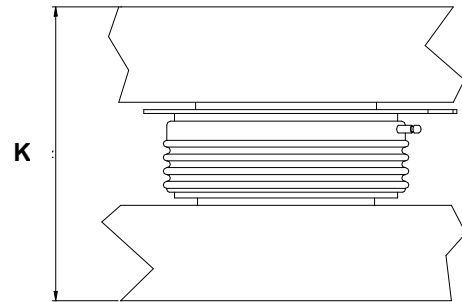
K: Total thickness of the assembly to be clamped

 For thicknesses $S'_{Min} < K < S_{Min}$ an additional 4mm thick bar spacer is needed (see list of special accessories)

Type GC89BN...F: suggested insulator/bolt types

Allowed clearance S			Insulator choice		Bolt choice		Max height
S'_{Min} [mm]**	S_{Min} [mm]	S_{Max} [mm]	(3)	Ins. Length [mm]	(4)	Bolt Length [mm]	T [mm]
29	33	48	A	50	Z	100	117
39	43	58	B	70	A	110	127
49	53	68	B	70	B	120	137
59	63	78	C	95	C	130	147
69	73	88	C	95	D	140	157
79	83	98	C	95	E	150	167
89	93	108	D	120	F	160	177

** with additional bar spacer only

Type GC89BR...F: suggested insulator/bolt types

Allowed clearance S			Insulator choice		Bolt choice		Max height
S'_{Min} [mm]**	S_{Min} [mm]	S_{Max} [mm]	(3)	Ins. Length [mm]	(4)	Bolt Length [mm]	T [mm]
29	33	48	A	50	Z	100	129
39	43	58	A	50	A	110	139
49	53	68	B	70	B	120	149
59	63	78	B	70	C	130	159
69	73	88	B	70	D	140	169
79	83	98	C	95	E	150	179
89	93	108	C	95	F	160	189

** with additional bar spacer only

Type GC89SN...F: suggested insulator/bolt types

Allowed clearance S			Insulator choice		Bolt choice		Max height
S'_{Min} [mm]**	S_{Min} [mm]	S_{Max} [mm]	(3)	Ins. Length [mm]	(4)	Bolt Length [mm]	T [mm]
29	33	48	A	50	Z	100	110
39	43	58	B	70	A	110	120
49	53	68	B	70	B	120	130
59	63	78	C	95	C	130	140
69	73	88	C	95	D	140	150
79	83	98	C	95	E	150	160
89	93	108	D	120	F	160	170

** with additional bar spacer only

Type GC89SR...F: suggested insulator/bolt types

Allowed clearance S			Insulator choice		Bolt choice		Max height
S'_{Min} [mm]**	S_{Min} [mm]	S_{Max} [mm]	(3)	Ins. Length [mm]	(4)	Bolt Length [mm]	T [mm]
49	53	68	B	70	Z	100	129
59	63	78	B	70	A	110	139
69	73	88	B	70	B	120	149
79	83	98	C	95	C	130	159
89	93	108	C	95	D	140	169
99	103	118	D	120	E	150	179
109	113	128	D	120	F	160	189

** with additional bar spacer only

BAR CLAMP OUTLINES

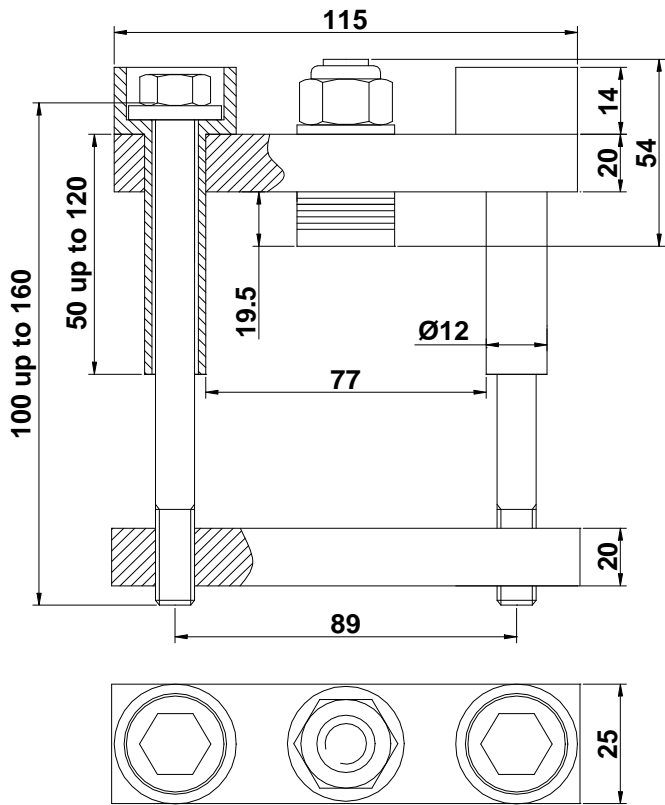

GC89BN...F

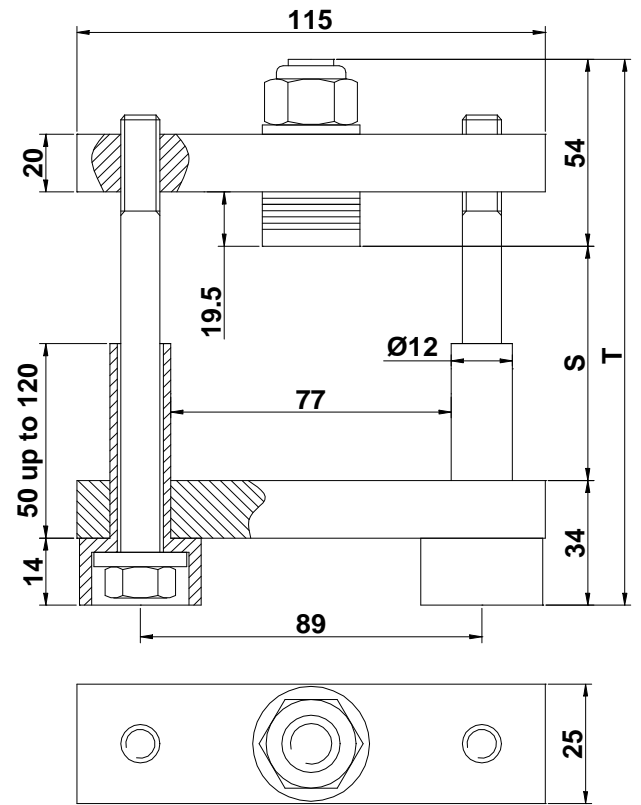

GC89BR...F

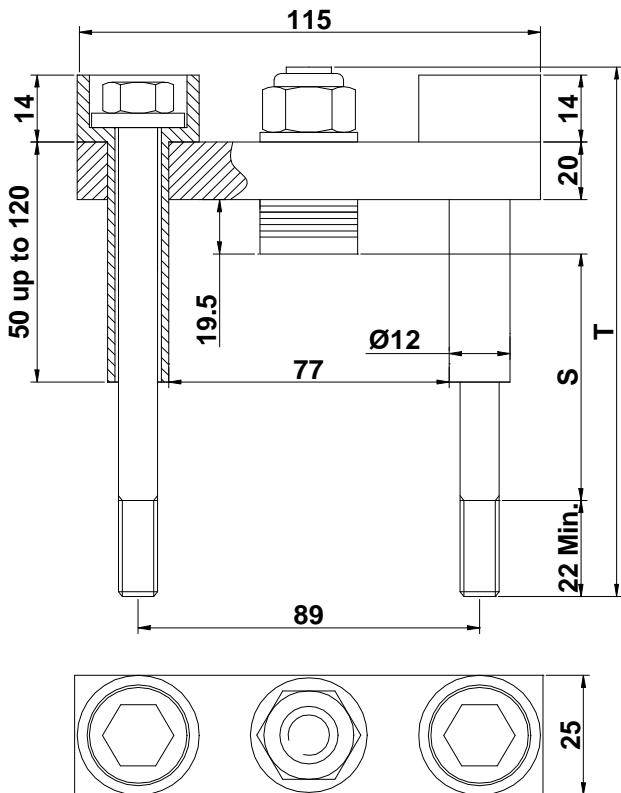

GC89SN...F

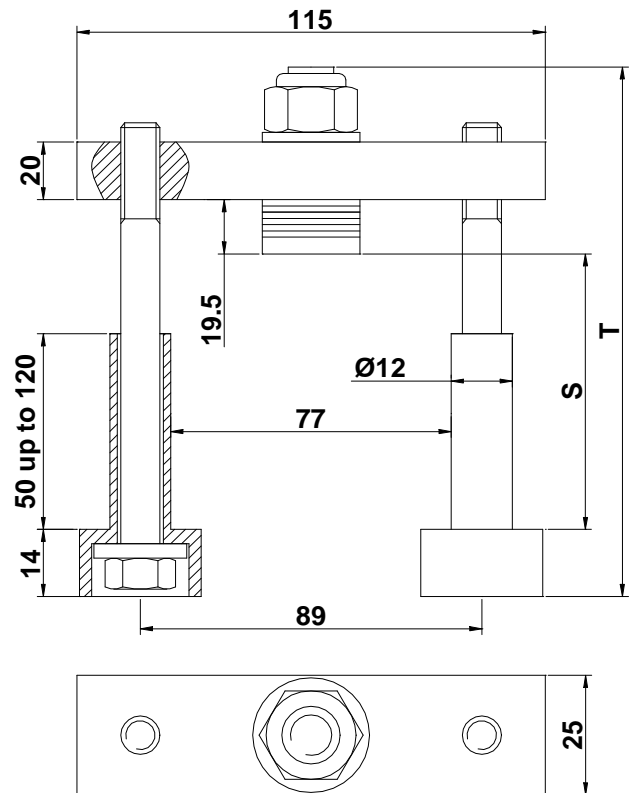

GC89SR...F

Dimensions in mm - Tolerances according to ISO 2768 MK

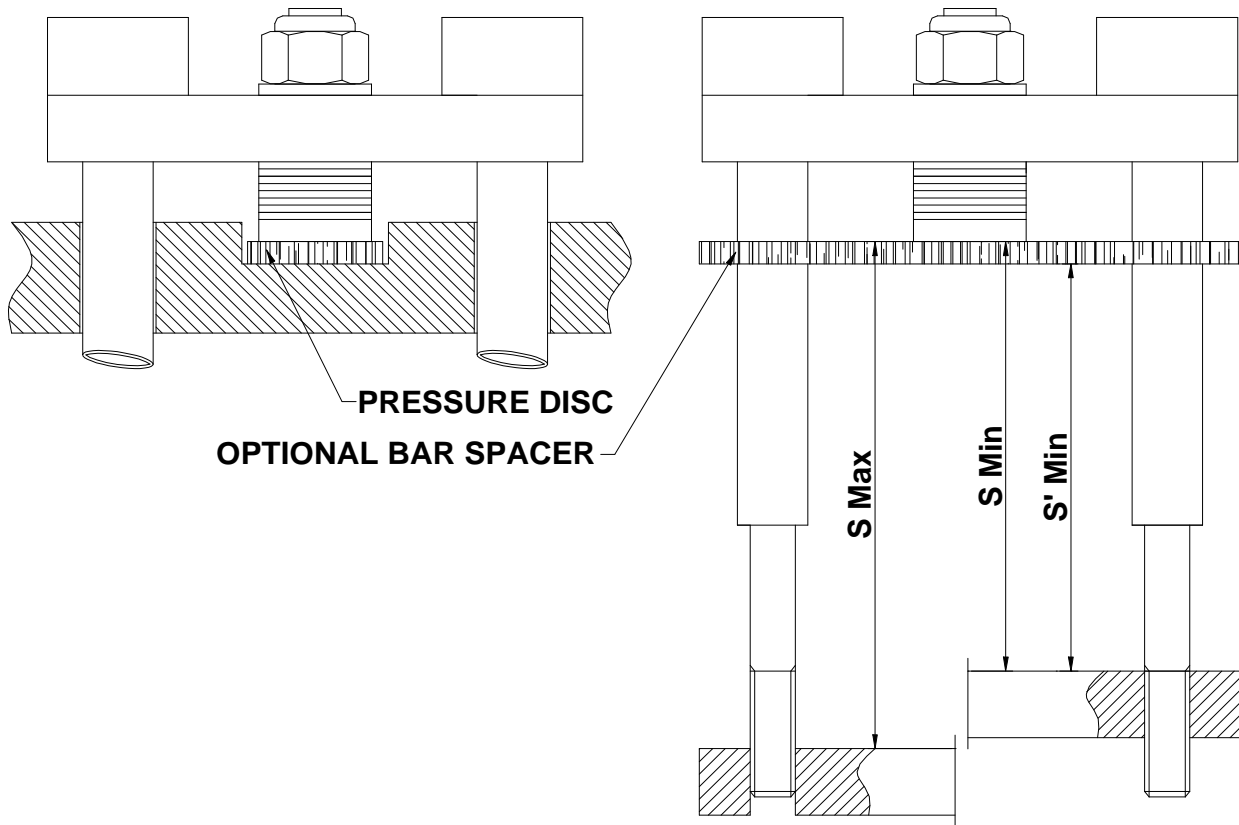

SPECIAL ACCESSORIES

The following special accessories are available on request (see ordering information table)

Bar spacer

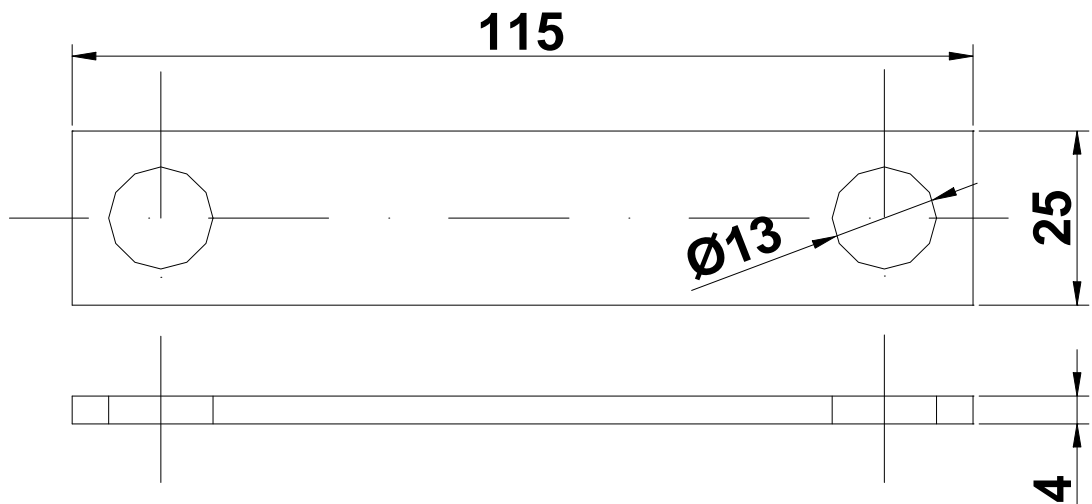

Dimensions in mm - Tolerances according to ISO 2768 MK

In the interest of product improvement Green Power Solutions reserves the right to change any specification given in this data sheet without notice.