

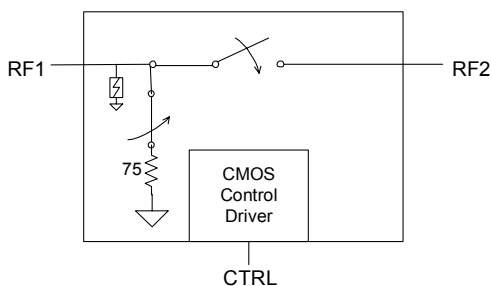
# PE4240

### Product Description

The PE4240 is a high-isolation MOSFET Switch designed for CATV applications, covering a broad frequency range from DC up to 1.3 GHz. This single-supply SPST switch offers a single-pin CMOS control interface with industry leading CTB performance. It also provides low insertion loss, high isolation and extremely low bias requirements while operating on a single 3-volt supply. In a typical CATV application, the PE4240 provides for a cost effective and manufacturable solution vs. mechanical relays.

The PE4240 is manufactured on Peregrine's UltraCMOS™ process, a patented variation of silicon-on-insulator (SOI) technology on a sapphire substrate, offering the performance of GaAs with the economy and integration of conventional CMOS.

### Figure 1. Functional Diagram



**Table 1. Electrical Specifications @ +25 °C ( $Z_S = Z_L = 75 \Omega$ )**

Parameter	Condition	Minimum	Typical	Maximum	Units
Operating Frequency <sup>1</sup>		DC		1300	MHz
Operating Power	On / Off			30/24	dBm
Insertion Loss	DC – 50 MHz 1000 MHz		0.5 0.75	0.65 1.0	dB
Isolation	DC – 50 MHz 1000 MHz	71 44	85 47		dB
Return Loss	DC - 1000 MHz	14	20		dB
Input 1 dB Compression <sup>2,4</sup>	1000 MHz	30	33		dBm
Input IP2 <sup>2</sup>	1000 MHz	80			dBm
CTB / CSO	77 & 110 channels; PO = 44 dBmV		-100		dBc
Input IP3 <sup>2</sup>	1000 MHz	50			dBm
Video Feedthrough <sup>3</sup>				15	mV <sub>pp</sub>
Switching Time			2		µs

Notes: 1. Device linearity will begin to degrade below 1 MHz.  
 2. Measured in a 50 Ω system.  
 3. Measured with a 1 ns risetime, 0/3 V pulse and 500 MHz bandwidth.  
 4. Note Absolute Maximum ratings in Table 3.

### SPST UltraCMOS™ CATV Switch DC - 1300 MHz

#### Features

- 75-ohm switch
- Non-reflective at RF1, open reflective at RF2 when OFF
- Integrated 0.25 watt terminations
- CTB performance of 100dBc
- High isolation: 85 dB at 5 MHz, 47 dB at 1 GHz
- Low insertion loss: 0.5 dB at 5 MHz, 0.75 dB at 1 GHz
- High input IP2: >80 dBm
- CMOS/TTL single-pin control
- Single +3 volt supply operation

### Figure 2. Package Type

6-lead DFN



Figure 3. Pin Configuration

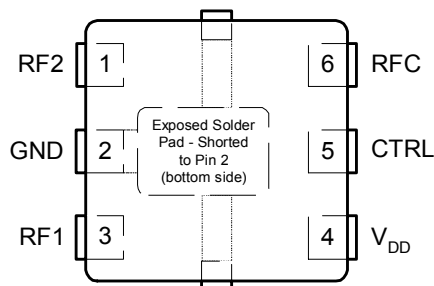


Table 2. Pin Descriptions

Pin No.	Pin Name	Description
1	V <sub>DD</sub>	Nominal 3 V supply connection. <sup>1</sup>
2	GND	Ground connection. <sup>3</sup>
3	RF1	RF port. <sup>2</sup>
4	CTRL	CMOS or TTL logic level: High = RF1 to RF2 signal path Low = RF1 isolated from RF2
5	GND	Ground connection. <sup>3</sup>
6	RF2	RF port. <sup>2</sup>

- Notes: 1. A bypass capacitor should be placed as close as possible to the pin.  
 2. Both RF pins must be held at 0 V<sub>AC</sub> or require external DC blocking capacitors.  
 3. The exposed pad must be soldered to the ground plane for proper switch performance.

Table 3. Absolute Maximum Ratings

Symbol	Parameter/Condition	Min	Max	Unit
V <sub>DD</sub>	Power supply voltage	-0.3	4.0	V
V <sub>I</sub>	Voltage on CTRL input	-0.3	5.5	V
T <sub>ST</sub>	Storage temperature	-65	150	°C
T <sub>OP</sub>	Operating temperature	-40	85	°C
P <sub>IN</sub>	Input power (50Ω), CTRL=1/CTRL=0		33/24	dBm
V <sub>ESD</sub>	ESD voltage (Human Body Model)		200	V

Absolute Maximum Ratings are those values listed in the above table. Exceeding these values may cause permanent device damage. Functional operation should be restricted to the limits in the DC Electrical Specifications table. Exposure to absolute maximum ratings for extended periods may affect device reliability.

Table 4. DC Electrical Specifications @ 25 °C

Parameter	Min	Typ	Max	Unit
V <sub>DD</sub> Power Supply	2.7	3.0	3.3	V
I <sub>DD</sub> Power Supply Current (V <sub>DD</sub> = 3V, V <sub>CTRL</sub> = 3V)		33	40	μA
Control Voltage High	70% V <sub>DD</sub>		5	V
Control Voltage Low	0		30% V <sub>DD</sub>	V

**Electrostatic Discharge (ESD) Precautions**

When handling this UltraCMOS™ device, observe the same precautions that you would use with other ESD-sensitive devices. Although this device contains circuitry to protect it from damage due to ESD, precautions should be taken to avoid exceeding the rating specified.

**Latch-Up Avoidance**

Unlike conventional CMOS devices, UltraCMOS™ devices are immune to latch-up.

**Device Description**

The PE4240 high isolation SPST CATV Switch is designed to support CATV applications such as premium channel service connect/disconnect switch blocks. This function is typically performed by bulky and expensive mechanical switches. The high isolation characteristics (>44 dB at 1 GHz, 85 dB at 5 MHz), high compression point, and an integrated 75-ohm terminations make the PE4240 an ideal, low cost solution.

Figure 4. Typical Application Block Diagram

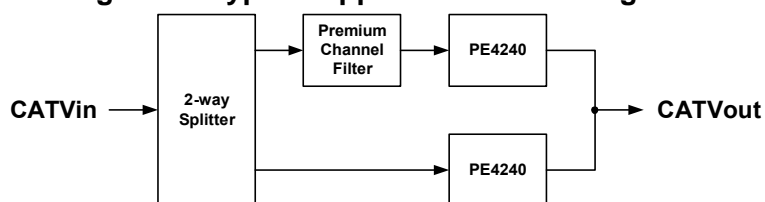


Table 5. Control Logic Truth Table

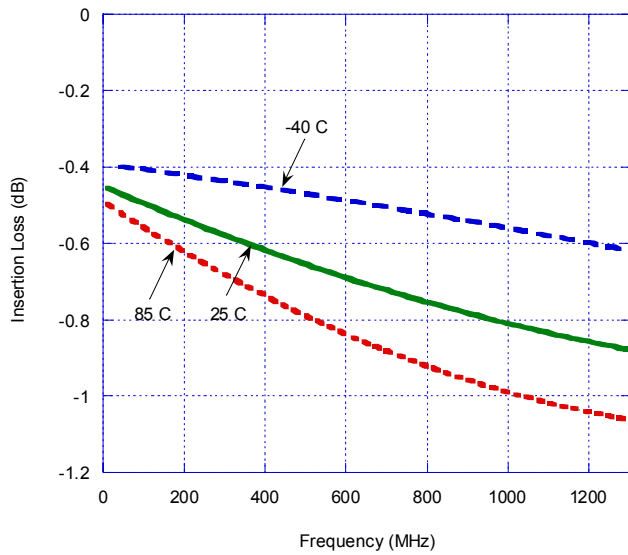
Control Voltage (CTRL)	Signal Path (RF1 to RF2)
High <sup>1</sup>	ON
Low	OFF

- Notes: 1. CTRL accepts both CMOS and TTL voltage leads.

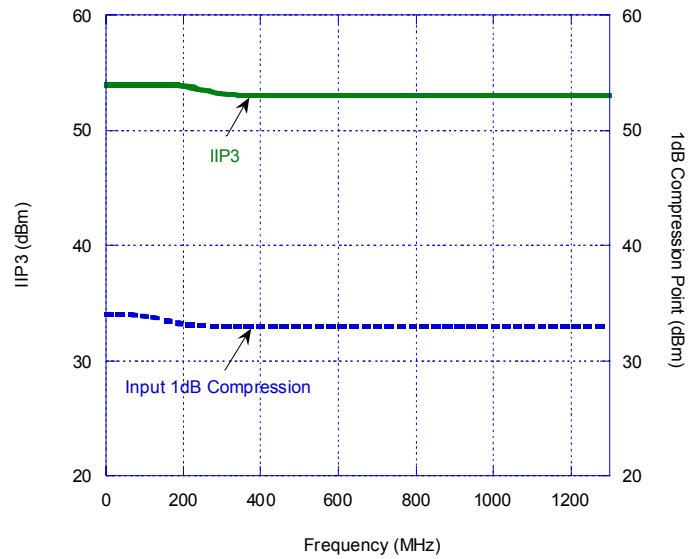
The control logic input pin (CTRL) is typically driven by a 3-volt CMOS logic level signal, and has a threshold of 50% of V<sub>DD</sub>. For flexibility to support systems that have 5-volt control logic drivers, the control logic input has been designed to handle a 5-volt logic HIGH signal. (A minimal current will be sourced out of the V<sub>DD</sub> pin when the control logic input voltage level exceeds V<sub>DD</sub>.)

**Typical Performance Data @ 25 °C (Unless Otherwise Noted)**  
**(75 Ω impedance except as indicated)**

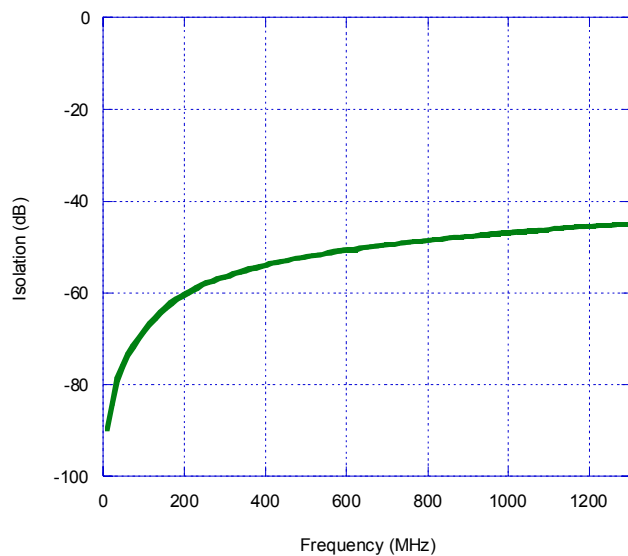
**Figure 5. Insertion Loss**



**Figure 6. Input 1dB Compression Point and IIP3**  
50 Ω system impedance

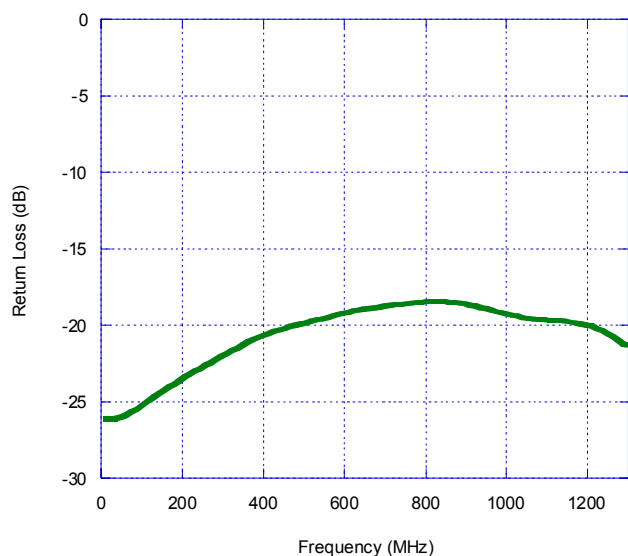


**Figure 7. Isolation**

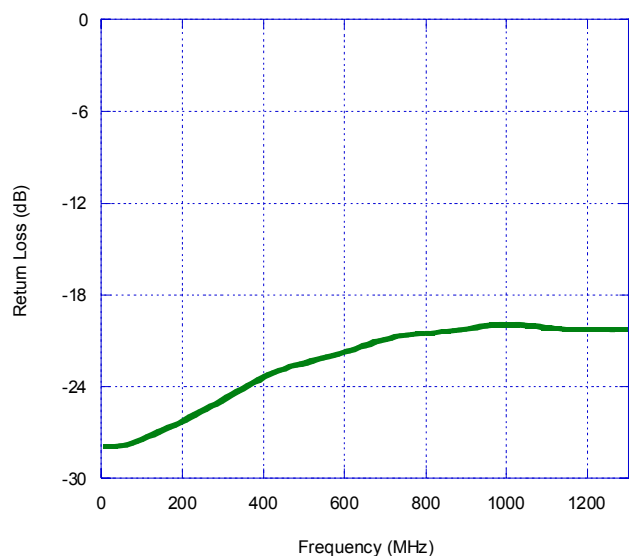


**Typical Performance Data @ 25 °C**  
(75 Ω impedance except as indicated)

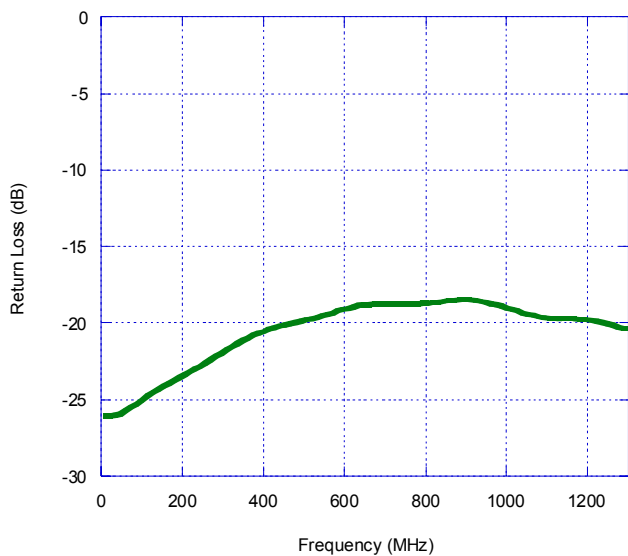
**Figure 8. RF1 Return Loss (Switch = ON)**



**Figure 9. RF1 Return Loss (Switch = OFF)**



**Figure 10. RF2 Return Loss (Switch = ON)**



## Evaluation Kit

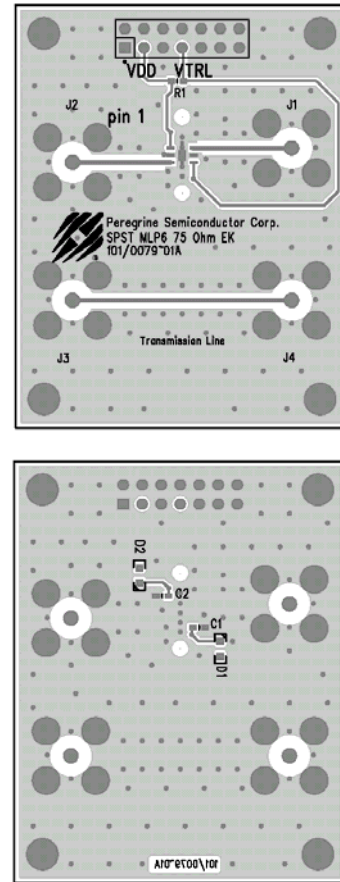
The SPST Switch Evaluation Kit board was designed to ease customer evaluation of the PE4240 SPST switch. The RF1 port is connected through a 75 Ω transmission line to the top left BNC connector, J1. The RF2 port is connected through a 75 Ω transmission line to the BNC connector on the top right side of the board, J2. A through transmission line connects BNC connectors J3 and J4. This transmission line can be used to estimate the loss of the PCB over the environmental conditions being evaluated.

The board is constructed of a two metal layer FR4 material with a total thickness of 0.031". The bottom layer provides ground for the RF transmission lines. The transmission lines were designed using a coplanar waveguide model with trace width of 0.021", trace gaps of 0.030", dielectric thickness of 0.028", metal thickness of 0.0021" and εR of 4.3. Note that the predominate mode for these transmission lines is coplanar waveguide with a ground plane.

J5 provides a means for controlling DC and digital inputs to the device. Starting from the lower left pin, the second pin to the right (J5-3) is connected to the device V<sub>DD</sub> input. The fourth pin to the right (J5-7) is connected to the device CTRL input. It is the responsibility of the customer to determine proper supply decoupling for their design application. Removing these components from the evaluation board has not been shown to degrade RF performance.

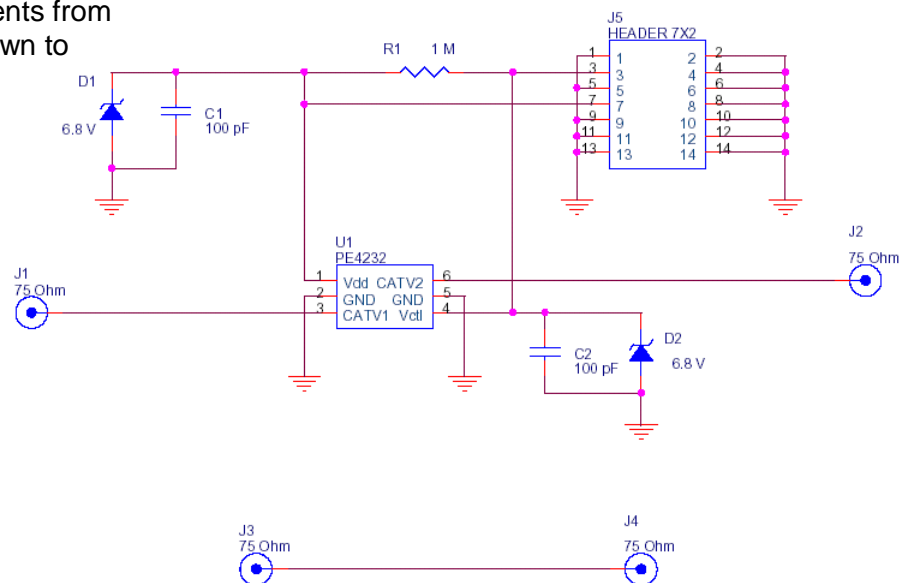
**Figure 11. Evaluation Board Layouts**

Peregrine Specification 101/0079



**Figure 12. Evaluation Board Schematic**

Peregrine Specification 102/0081







## Sales Offices

### *The Americas*

#### **Peregrine Semiconductor Corporation**

9450 Carroll Park Drive  
San Diego, CA 92121  
Tel 858-731-9400  
Fax 858-731-9499

### *Europe*

#### **Peregrine Semiconductor Europe**

Bâtiment Maine  
13-15 rue des Quatre Vents  
F-92380 Garches, France  
Tel: +33-1-47-41-91-73  
Fax : +33-1-47-41-91-73

#### **Space and Defense Products**

##### **Americas:**

Tel: 505-881-0438  
Fax: 505-881-0443

##### **Europe, Asia Pacific:**

180 Rue Jean de Guiramand  
13852 Aix-En-Provence cedex 3, France  
Tel: +33(0) 4 4239 3361  
Fax: +33(0) 4 4239 7227

### *North Asia Pacific*

#### **Peregrine Semiconductor K.K.**

5A-5, 5F Imperial Tower  
1-1-1 Uchisaiwaicho, Chiyoda-ku  
Tokyo 100-0011 Japan  
Tel: +81-3-3502-5211  
Fax: +81-3-3502-5213

#### **Peregrine Semiconductor, Korea**

#B-2402, Kolon Tripolis, #210  
Geumgok-dong, Bundang-gu, Seongnam-si  
Gyeonggi-do, 463-480 S. Korea  
Tel: +82-31-728-4300  
Fax: +82-31-728-4305

### *South Asia Pacific*

#### **Peregrine Semiconductor, China**

Shanghai, 200040, P.R. China  
Tel: +86-21-5836-8276  
Fax: +86-21-5836-7652

For a list of representatives in your area, please refer to our Web site at: [www.psemi.com](http://www.psemi.com)

## Data Sheet Identification

### **Advance Information**

The product is in a formative or design stage. The data sheet contains design target specifications for product development. Specifications and features may change in any manner without notice.

### **Preliminary Specification**

The data sheet contains preliminary data. Additional data may be added at a later date. Peregrine reserves the right to change specifications at any time without notice in order to supply the best possible product.

### **Product Specification**

The data sheet contains final data. In the event Peregrine decides to change the specifications, Peregrine will notify customers of the intended changes by issuing a DCN (Document Change Notice).

The information in this data sheet is believed to be reliable. However, Peregrine assumes no liability for the use of this information. Use shall be entirely at the user's own risk.

No patent rights or licenses to any circuits described in this data sheet are implied or granted to any third party.

Peregrine's products are not designed or intended for use in devices or systems intended for surgical implant, or in other applications intended to support or sustain life, or in any application in which the failure of the Peregrine product could create a situation in which personal injury or death might occur. Peregrine assumes no liability for damages, including consequential or incidental damages, arising out of the use of its products in such applications.

The Peregrine name, logo, and UTSi are registered trademarks and UltraCMOS and HaRP are trademarks of Peregrine Semiconductor Corp.