



# Dual PCI 2.2 Hot-Swap Controllers

## General Description

The MAX5915/MAX5915A/MAX5916/MAX5916A dual PCI 2.2 hot-swap controllers allow for safe insertion and removal of two PCI cards into live PCI slots or backplanes by limiting the inrush current at startup. After startup, these devices provide protection against short-circuit, overcurrent, and undervoltage conditions.

The MAX5915/MAX5915A/MAX5916/MAX5916A provide independent power controls for +3.3V, +5V,  $\pm 12V$ , and +3.3V auxiliary supplies of two PCI cards. These devices provide intelligent selective thermal shutdown control that shuts down the channel with an overcurrent fault. All devices include internal power MOSFETs for the +12V, -12V, and +3.3V auxiliary outputs. These devices use internal charge pumps to activate the gates of the internal FETs controlling the +3.3V auxiliary supply. Internal FETs and current-sense circuitry regulate the  $\pm 12V$  and the +3.3V auxiliary supplies. Channels A and B operate independently, allowing a single device to monitor two PCI card slots.

The MAX5915/MAX5915A offer latched fault protection and the MAX5916/MAX5916A offer autorestart fault protection. The devices are available in the low-profile 28-pin TSSOP package.

## Ordering Information

PART	TEMP RANGE	PIN-PACKAGE
MAX5915EUI*	-40°C to +85°C	28 TSSOP
MAX5915UUI	0°C to +85°C	28 TSSOP
MAX5915AEUI*	-40°C to +85°C	28 TSSOP
MAX5915AUUI	0°C to +85°C	28 TSSOP
MAX5916EUI*	-40°C to +85°C	28 TSSOP
MAX5916UUI	0°C to +85°C	28 TSSOP
MAX5916AEUI*	-40°C to +85°C	28 TSSOP
MAX5916AUUI	0°C to +85°C	28 TSSOP

\*Contact factory for availability.

## Features

- ◆ PCI 2.2 Compliant
- ◆ Independent Power Controls for +3.3V, +5V,  $\pm 12V$ , and +3.3V Auxiliary Supplies of Two PCI Cards
- ◆ Internal MOSFET Switches for  $\pm 12V$  and +3.3V Auxiliary Outputs
- ◆ Separate ON/OFF Control Input for Each Channel
- ◆ Independent +3.3V Auxiliary Output ON/OFF Control
- ◆ Overcurrent Foldback with Timeout and Shutdown Protection for  $\pm 12V$  and +3.3V Auxiliary Rails with Status Report
- ◆ Brick Wall with Timeout and Shutdown Protection for +5V and +3.3V Rails with Status Report
- ◆ Output Undervoltage Monitoring for +3.3V, +5V, +12V, and +3.3V Auxiliary Rails with Status Report
- ◆ +3.3V Auxiliary Autorestart
- ◆ Intelligent Selective Thermal Shutdown Control Shuts Down Only the Channel with an Overcurrent Fault
- ◆ 28-Pin TSSOP Package

## Applications

PCI 2.2 Server  
PCI Server  
RAID

Selector Guide, Pin Configuration, Functional Diagram, and Typical Operating Circuit appear at end of data sheet.

## Typical Application Circuit

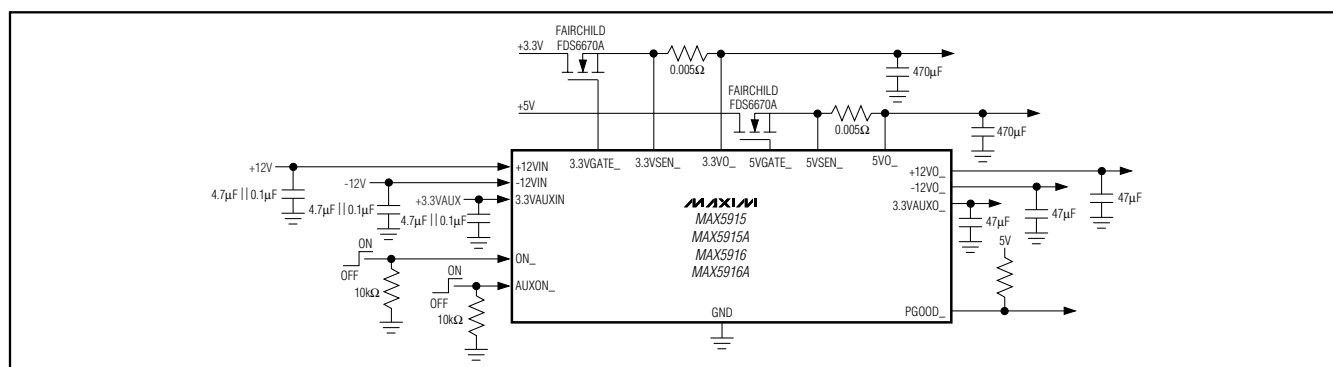

# Dual PCI 2.2 Hot-Swap Controllers

## ABSOLUTE MAXIMUM RATINGS

+12VIN to GND .....	-0.3V to +14.0V
-12VIN to GND.....	-14V to +0.3V
-12VO_ to GND.....	+0.3V to (V <sub>-12VIN</sub> - 0.3V)
+12VO_, 3.3VGATE_, 5VGATE_ to GND.....	-0.3V to (V <sub>+12VIN</sub> + 0.3V)
Any Other Pin to GND .....	-0.3V to +6.0V
Continuous Power Dissipation (T <sub>A</sub> = +70°C)	
28-Pin TSSOP (derate 23.8mW/°C above +70°C) .....	1.9W

### Operating Temperature Ranges:

MAX591_U_ .....	0°C to +85°C
MAX591_A U_ .....	0°C to +85°C
MAX591_E_ .....	-40°C to +85°C
MAX591_AE_ .....	-40°C to +85°C
Maximum Junction Temperature .....	+150°C
Storage Temperature Range .....	-65°C to +150°C
Lead Temperature (soldering, 10s) .....	+300°C

Stresses beyond those listed under "Absolute Maximum Ratings" may cause permanent damage to the device. These are stress ratings only, and functional operation of the device at these or any other conditions beyond those indicated in the operational sections of the specifications is not implied. Exposure to absolute maximum rating conditions for extended periods may affect device reliability.

## ELECTRICAL CHARACTERISTICS

(V<sub>-12VIN</sub> = -12V, V<sub>+12VIN</sub> = +12V, V<sub>3.3VAUXIN</sub> = +3.3V, V<sub>ON\_</sub> = V<sub>AUXON\_</sub> = +5V, T<sub>A</sub> = T<sub>MIN</sub> to T<sub>MAX</sub>, unless otherwise specified. Typical values are at T<sub>A</sub> = +25°C.)

PARAMETER	SYMBOL	CONDITIONS	MIN	TYP	MAX	UNITS
<b>POWER SUPPLIES</b>						
Main Supply Input Voltage Range	V <sub>+12VIN</sub>		10.8	12	13.2	V
Main Supply Undervoltage Lockout (UVLO)	V <sub>+12UVLO</sub>	V <sub>+12VIN</sub> rising	9.6	10	10.8	V
Main Supply UVLO Hysteresis	V <sub>UVLO, HYS</sub>			100		mV
Main Input UVLO Delay Time	t <sub>DEG, UVLO</sub>	Figures 1 and 2 (Note 1)		1.6		ms
Supply Current	I <sub>Q</sub>			2.5	5.0	mA
<b>+3.3V SUPPLY CONTROL</b>						
Gate Charge Current	I <sub>3.3VGATE_, CHG</sub>	V <sub>3.3VGATE_</sub> = +6V, V <sub>3.3VSEN_</sub> = +3.3V, V <sub>3.3VO_</sub> = +3.3V	5	15	30	μA
Gate Discharge Current	I <sub>3.3VGATE_, DIS</sub>	V <sub>3.3VGATE_</sub> = +12V, V <sub>ON_</sub> = 0V	50	150	250	μA
Gate High Voltage	V <sub>3.3VGATE_, HIGH</sub>	I <sub>3.3VGATE_</sub> = 1μA	V <sub>+12VIN</sub> - 0.5		V <sub>+12VIN</sub>	V
Gate Low Voltage	V <sub>3.3VGATE_, LOW</sub>	I <sub>3.3VGATE_</sub> = 1μA, V <sub>ON_</sub> = 0V		0.1	0.4	V
3.3VO_ Input Bias Current	I <sub>3.3VO_, BIAS</sub>	V <sub>3.3VO_</sub> = +3.3V			20	μA
3.3VO_ Internal Pulldown	RPD	V <sub>ON_</sub> = 0V		1		kΩ
3.3VSEN_ Input Bias Current	I <sub>3.3VSEN_, BIAS</sub>	V <sub>3.3VSEN_</sub> = +3.3V			10	μA
Current-Limit Threshold	V <sub>3.3V, LIM</sub>	V <sub>3.3VGATE_</sub> = +6V	41	46	51	mV
Output Undervoltage Threshold	V <sub>3.3VIN, UV</sub>	V <sub>3.3VGATE_</sub> falling	2.79	2.89	2.99	V
Output Undervoltage Threshold Hysteresis				30		mV

# Dual PCI 2.2 Hot-Swap Controllers

MAX5915/MAX5915A/MAX5916/MAX5916A

## ELECTRICAL CHARACTERISTICS (continued)

( $V_{-12VIN} = -12V$ ,  $V_{+12VIN} = +12V$ ,  $V_{3.3VAUXIN} = +3.3V$ ,  $V_{ON\_} = V_{AUXON\_} = +5V$ ,  $T_A = T_{MIN}$  to  $T_{MAX}$ , unless otherwise specified. Typical values are at  $T_A = +25^\circ C$ .)

PARAMETER	SYMBOL	CONDITIONS	MIN	TYP	MAX	UNITS
<b>+5V SUPPLY CONTROL</b>						
Gate Charge Current	$I_{5VGATE\_ , CHG}$	$V_{5VGATE\_} = +6V$ , $V_{5VSEN\_} = +5V$ , $V_{5VO\_} = +5V$	5	15	30	$\mu A$
Gate Discharge Current	$I_{5VGATE\_ , DIS}$	$V_{5VGATE\_} = +12V$ , $V_{ON\_} = 0V$	50	150	250	$\mu A$
Gate High Voltage	$V_{5VGATE\_ , HIGH}$	$I_{5VGATE\_} = 1\mu A$	$V_{+12VIN} - 0.5V$		$V_{+12VIN}$	V
Gate Low Voltage	$V_{5VGATE\_ , LOW}$	$I_{5VGATE\_} = 1\mu A$ , $V_{ON\_} = 0V$	0.1		0.4	V
5VO_ Input Bias Current	$I_{5VO\_ , BIAS}$	$V_{5VO\_} = +5V$			20	$\mu A$
5VO_ Internal Pulldown	$R_{5VO\_ , PD}$	$V_{ON\_} = 0V$	1			k $\Omega$
5VSEN_ Input Bias Current	$I_{5VSEN\_ , BIAS}$	$V_{5VSEN\_} = +5V$			10	$\mu A$
Current-Limit Threshold	$V_{5VO\_ , LIM}$	$V_{5VGATE\_}$ falling	27	31	35	mV
Output Undervoltage Threshold	$V_{5VO\_ , UV}$	Output falling	4.34	4.50	4.70	V
Output Undervoltage Threshold Hysteresis			45			mV
<b>+12V SUPPLY CONTROL</b>						
On-Resistance of Internal Switch	$R_{DS(ON), +12V}$	$T_A = +25^\circ C$ , $I_D = 0.5A$	0.32		0.38	$\Omega$
		$T_A = +85^\circ C$ , $I_D = 0.5A$			0.5	
Foldback Current Limit	$I_{+12VIN, LIM}$	$V_{+12VO\_} = 0V$	0.68	1	1.36	A
Current-Foldback Threshold		Output current rising (Note 2)	1.4			A
Output Undervoltage Threshold	$V_{+12VO\_ , UV}$	Output falling	10.00	10.4	10.82	V
+12VO_ Internal Pulldown	$R_{+12VO\_ , PD}$	$V_{ON\_} = 0V$	1			k $\Omega$
<b>-12V SUPPLY CONTROL</b>						
On-Resistance of Internal Switch	$R_{DS(ON), -12V}$	$T_A = +25^\circ C$ , $I_D = 0.1A$	0.58		0.9	$\Omega$
		$T_A = +85^\circ C$ , $I_D = 0.1A$			1.3	
Foldback Current Limit	$I_{-12VIN, LIM}$	$V_{-12VO\_} = 0V$	136	205	273	mA
Current-Foldback Threshold		Output current rising (Note 2)	240			mA
-12VO_ Internal Pullup	$R_{-12VO\_ , PU}$	$V_{ON\_} = 0V$	1			k $\Omega$
<b>+3.3VAUX SUPPLY CONTROL</b>						
Input Voltage Range	$V_{3.3VAUXIN}$		3.0	3.3	3.6	V
3.3VAUXIN Undervoltage Lockout	$V_{UVLO, AUX}$	Input rising	2.65	2.75	2.85	V
Hysteresis	$V_{UVLO-AUX, HYS}$		30			mV
Supply Current	$I_Q, 3.3VAUX$		1		2	mA

## Dual PCI 2.2 Hot-Swap Controllers

### ELECTRICAL CHARACTERISTICS (continued)

( $V_{-12VIN} = -12V$ ,  $V_{+12VIN} = +12V$ ,  $V_{3.3VAUXIN} = +3.3V$ ,  $V_{ON\_} = V_{AUXON\_} = +5V$ ,  $T_A = T_{MIN}$  to  $T_{MAX}$ , unless otherwise specified. Typical values are at  $T_A = +25^\circ C$ .)

PARAMETER	SYMBOL	CONDITIONS	MIN	TYP	MAX	UNITS
On-Resistance of Internal Switch	$R_{DS(ON)}$ , 3.3VAUX	$T_A = +25^\circ C$ , $I_D = 0.4A$		0.24	0.4	$\Omega$
		$T_A = +85^\circ C$ , $I_D = 0.4A$			0.6	
Foldback Current Limit	$I_{3.3VAUXIN, LIM}$	$V_{3.3VAUXO\_} = 0V$	0.5	0.75	1.0	A
Current-Foldback Threshold		Output current rising (Note 2)		1.2		A
Output Undervoltage Threshold	$V_{3.3VAUXIN, UV}$		2.76	2.89	2.99	V
Auxiliary Input UVLO Delay Time	$t_{DEG, UVLO}$	(Note 1)		1.6		ms
3.3VAUXO_ Internal Pulldown	$R_{3.3VAUXO\_}$	$ON\_ = 0V$		1		k $\Omega$
<b>ON AND AUXON COMPARATORS</b>						
Threshold Voltage			1.0		2.1	V
Hysteresis	$V_{HYS}$			25		mV
Input Bias Current	$I_{B, COMP}$				20	$\mu A$
ON_ and AUXON_ Deglitch Time	$t_{DEG}$	Figures 5–8 (Note 3)		4		$\mu s$
<b>FAULT RESPONSE, PGOOD_ STATUS OUTPUT COMPARATORS</b>						
PGOOD_ Output Overcurrent and Undervoltage Response Time	$t_{RESP}$	Figures 5–8	MAX5915/MAX5916	0.5	1.5	ms
	$t_{RESP2}$	Figures 5–8	MAX5915A/MAX5916A		100	ns
Output Overcurrent and Undervoltage Deglitch Time	$t_{DELAY}$	Figures 3–7		16 x $t_{RESP}$		ms
PGOOD_ Startup Timeout	$t_{START}$	See Figures 1, 2, 5, 6, 7, and 8		4 x $t_{DELAY}$		ms
Autorestart Delay	$t_{RESTART}$	Delay time to restart after OC and/or UV shutdown		64 x $t_{START}$		ms
PGOOD_ Output Low Voltage	$V_{OL}$	$I_{SINK} = 2mA$ , $ON\_ = 0V$		0.5	0.7	V
PGOOD_ Output High Leakage Current	$I_{LEAK}$	$V_{PGOOD\_} = +5.5V$			1	$\mu A$
Thermal Shutdown Threshold	$T_{SD}$	(Note 4)		125		$^\circ C$
Thermal Shutdown Hysteresis	$T_{HYS}$			5		$^\circ C$
Full Thermal Shutdown Threshold	$T_{SD, FULL}$	(Note 5)		$T_{SD} + 20$		$^\circ C$
Full Thermal Shutdown Hysteresis	$T_{HYS, FULL}$			5		$^\circ C$

**Note 1:**  $t_{DEG, UVLO}$  is negative edge triggered. There is no time delay when the inputs rise above the UVLO threshold.

**Note 2:** The current threshold when the output current starts to fold back. See the *Typical Operating Characteristics*.

**Note 3:**  $t_{DEG}$  is negative edge triggered. ON\_ or AUXON\_ transition from low to high has no delay.

**Note 4:** Temperature threshold at which the outputs of the channel with overcurrent shut down.

**Note 5:** The temperature threshold at which both channels shut down.

# Dual PCI 2.2 Hot-Swap Controllers

## Typical Operating Characteristics

( $V_{+12VIN} = +12V$ ,  $V_{3.3VAUXIN} = +3.3V$ ,  $V_{-12VIN} = -12V$ ,  $V_{5V} = +5V$ ,  $V_{3.3V} = +3.3V$ ,  $R_{5VSEN\_} = 0.005\Omega$ ,  $R_{3.3VSEN\_} = 0.005\Omega$ ,  $C_{3.3VO\_} =$

MAX5915/MAX5915A/MAX5916/MAX5916A

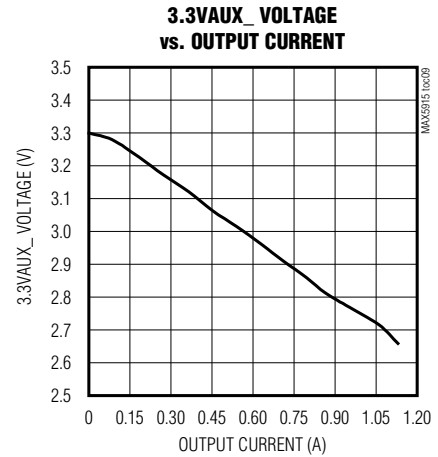
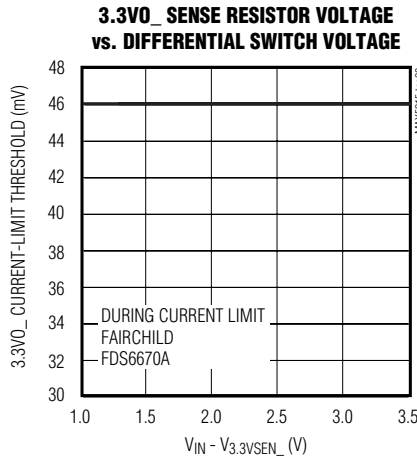
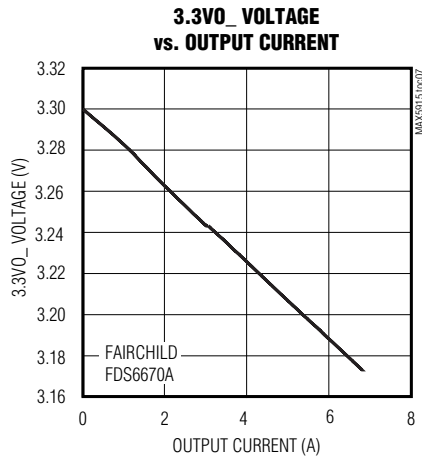
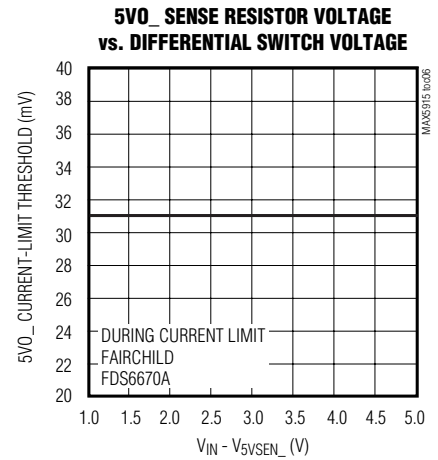
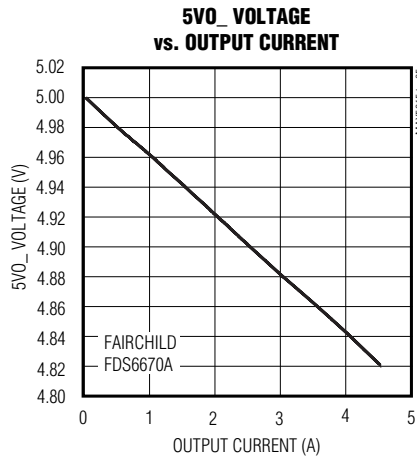
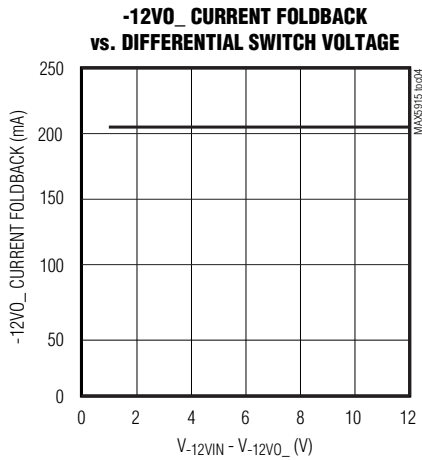
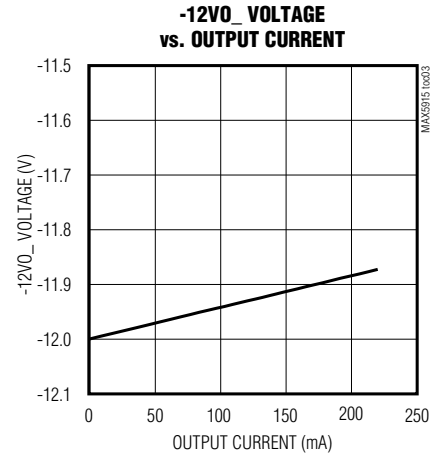
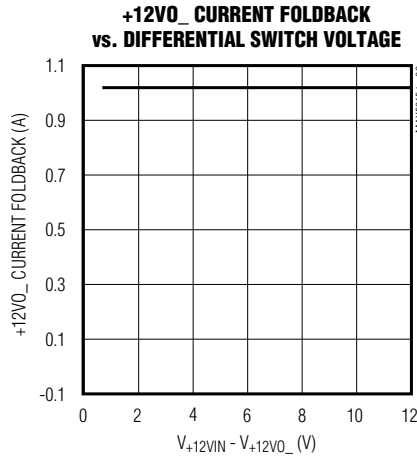
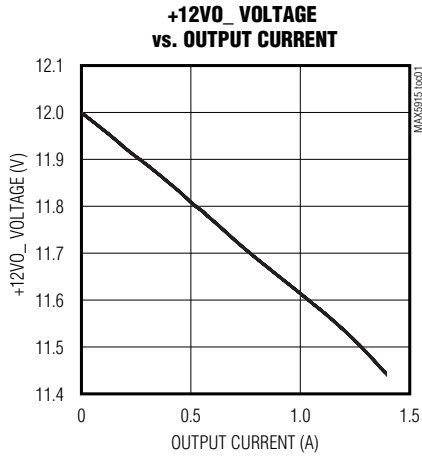

# Dual PCI 2.2 Hot-Swap Controllers

## Typical Operating Characteristics (continued)

( $V_{+12VIN} = +12V$ ,  $V_{3.3VAUXIN} = +3.3V$ ,  $V_{-12VIN} = -12V$ ,  $V_{5V} = +5V$ ,  $V_{3.3V} = +3.3V$ ,  $R_{5VSEN\_} = 0.005\Omega$ ,  $R_{3.3VSEN\_} = 0.005\Omega$ ,  $C_{3.3VO\_} =$

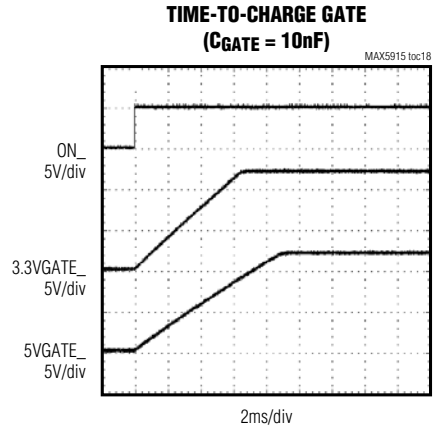
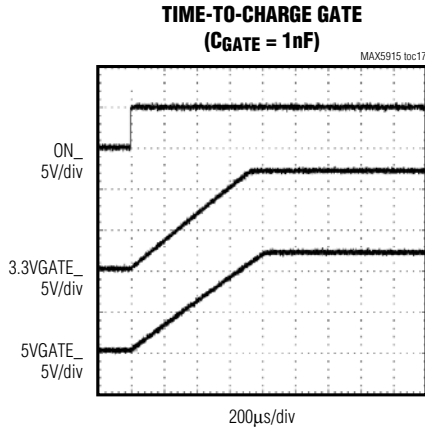
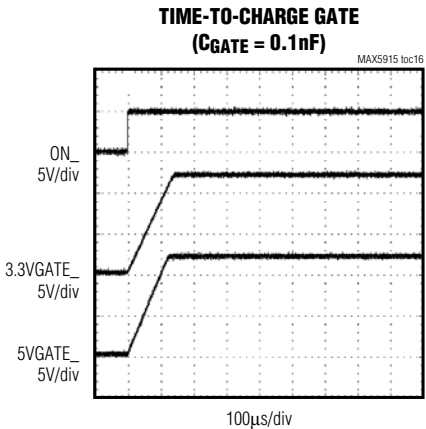
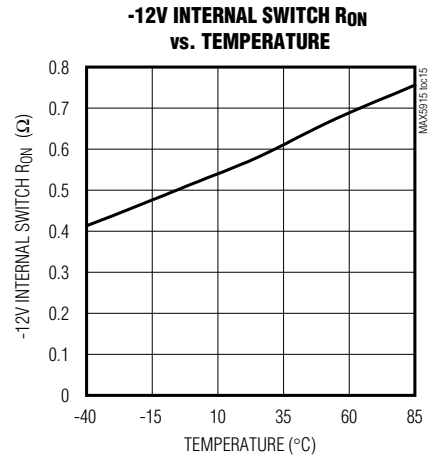
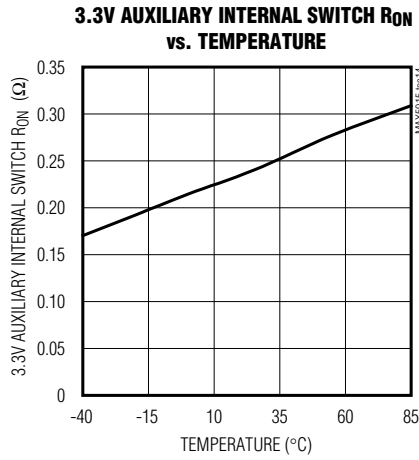
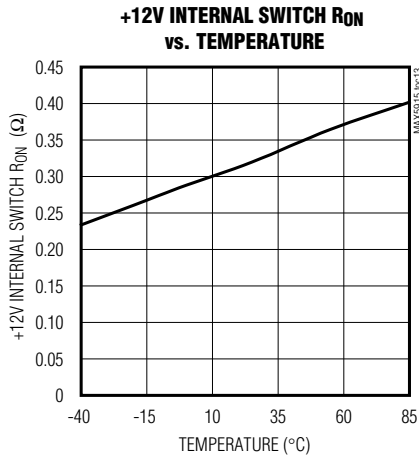
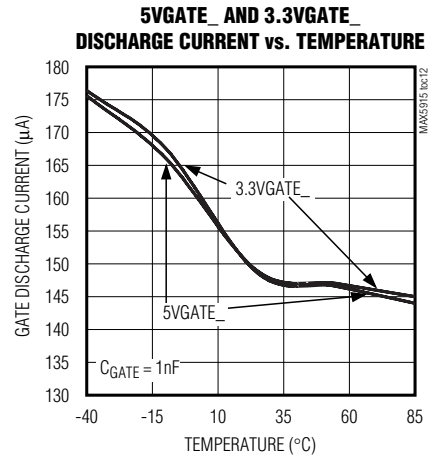
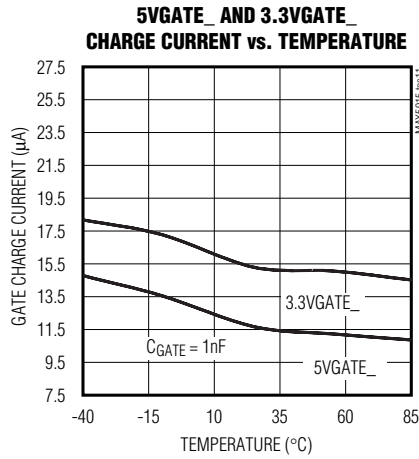
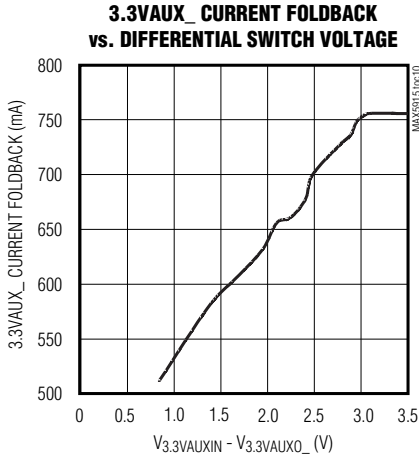

# Dual PCI 2.2 Hot-Swap Controllers

## Typical Operating Characteristics (continued)

( $V_{+12VIN} = +12V$ ,  $V_{3.3VAUXIN} = +3.3V$ ,  $V_{-12VIN} = -12V$ ,  $V_{5V} = +5V$ ,  $V_{3.3V} = +3.3V$ ,  $R_{5VSEN\_} = 0.005\Omega$ ,  $R_{3.3VSEN\_} = 0.005\Omega$ ,  $C_{3.3VO\_} =$

MAX5915/MAX5915A/MAX5916/MAX5916A

**+12VIN SUPPLY CURRENT vs. TEMPERATURE**

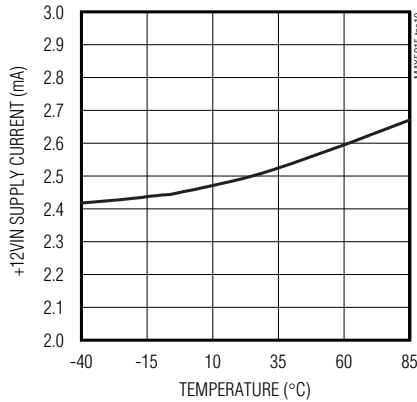

**3.3VAUXIN SUPPLY CURRENT vs. TEMPERATURE**

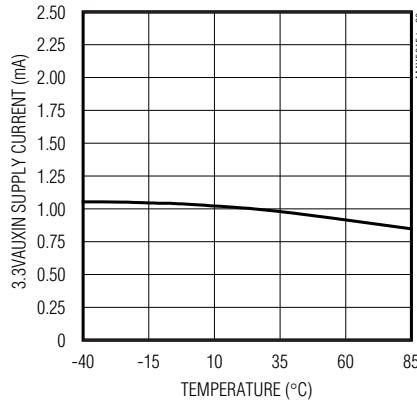

**ON\_ AND AUXON\_ THRESHOLD vs. TEMPERATURE**

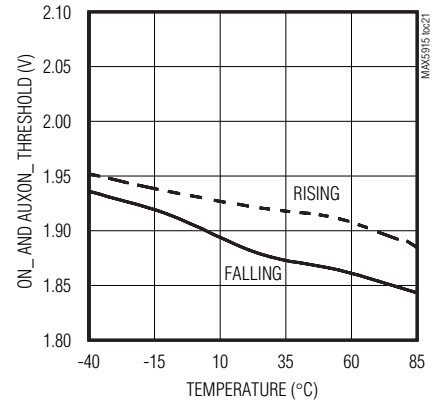

**+12V OUTPUT UNDERVOLTAGE THRESHOLD vs. TEMPERATURE**

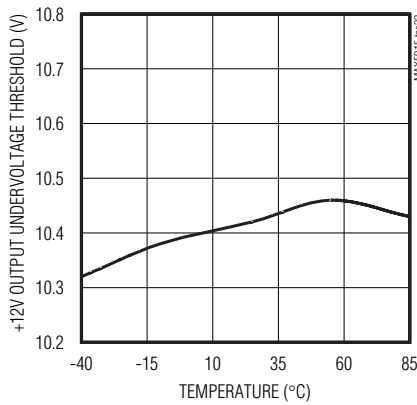

**5V OUTPUT UNDERVOLTAGE THRESHOLD vs. TEMPERATURE**

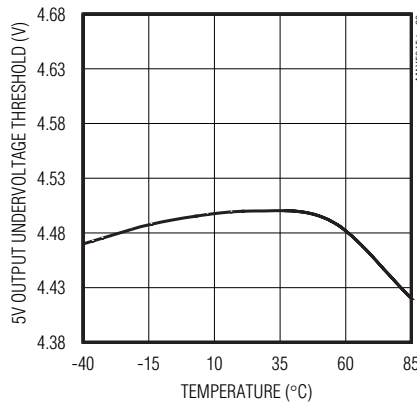

**3.3V OUTPUT UNDERVOLTAGE THRESHOLD vs. TEMPERATURE**

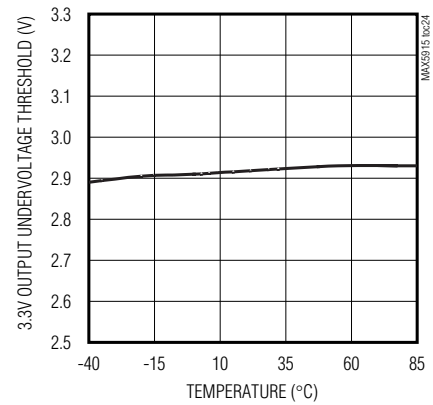

**3.3V AUXILIARY OUTPUT UNDERVOLTAGE THRESHOLD vs. TEMPERATURE**

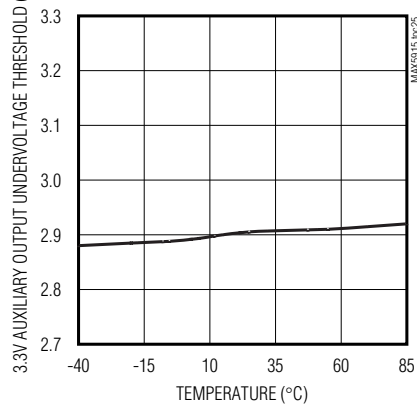

**3.3V AUXILIARY INPUT UVLO THRESHOLD vs. TEMPERATURE**

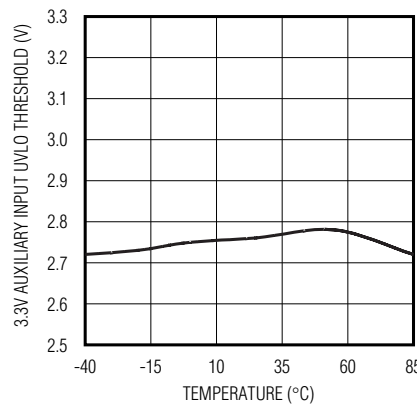

**+12V INPUT UVLO THRESHOLD vs. TEMPERATURE**

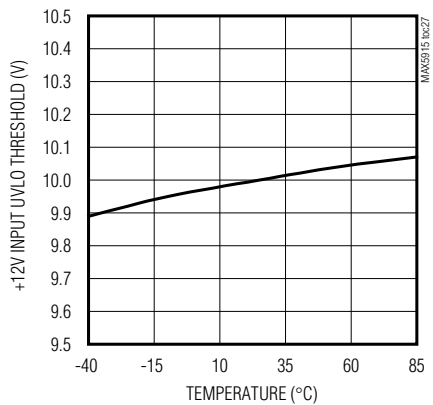

# Dual PCI 2.2 Hot-Swap Controllers

## Typical Operating Characteristics (continued)

( $V_{+12VIN} = +12V$ ,  $V_{3.3VAUXIN} = +3.3V$ ,  $V_{-12VIN} = -12V$ ,  $V_{5V} = +5V$ ,  $V_{3.3V} = +3.3V$ ,  $R_{5VSEN\_} = 0.005\Omega$ ,  $R_{3.3VSEN\_} = 0.005\Omega$ ,  $C_{3.3VO\_} =$

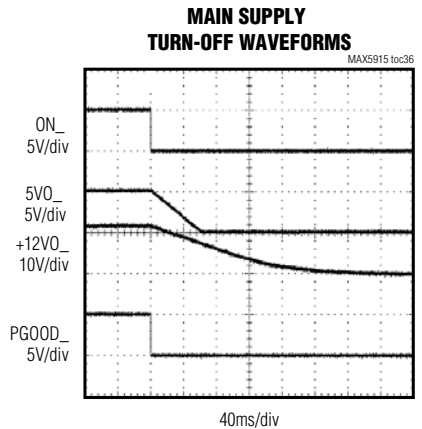
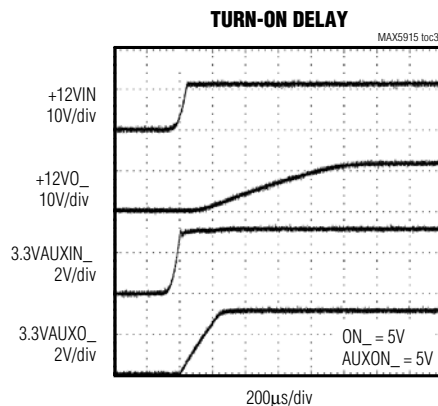
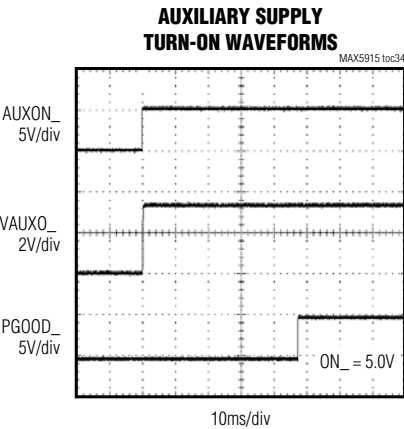
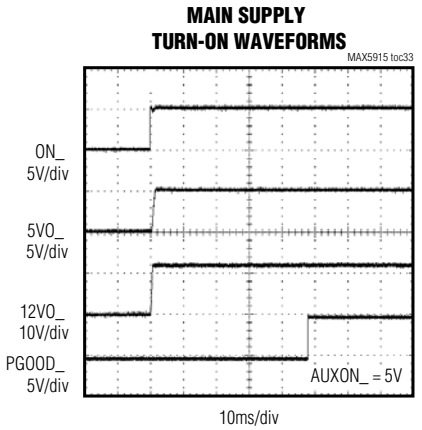
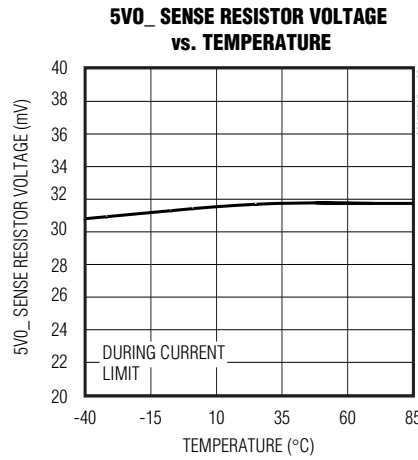
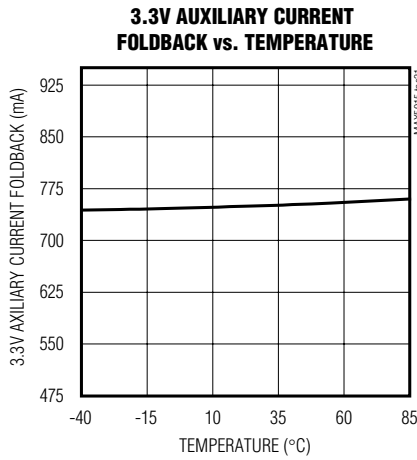
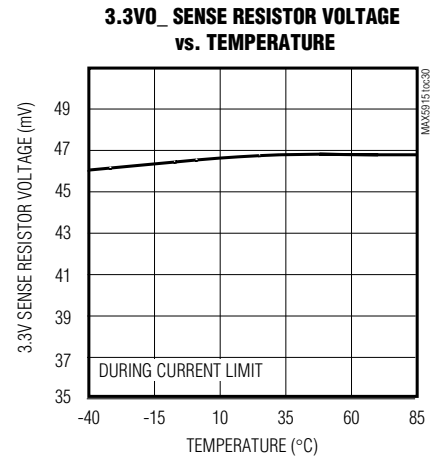
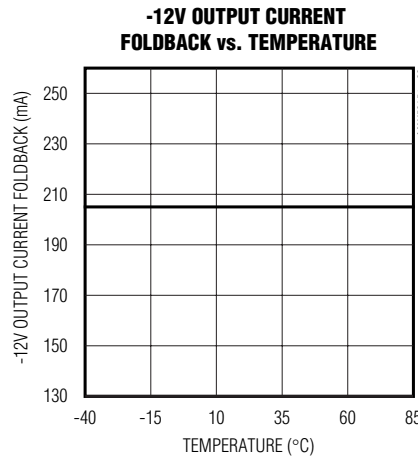
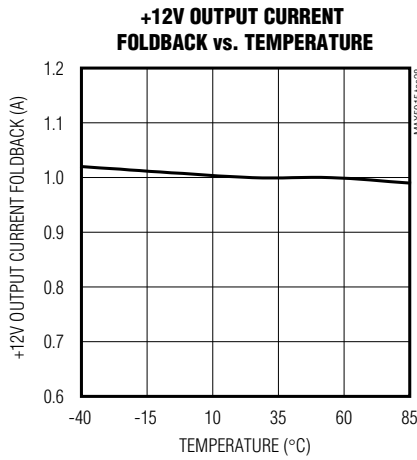



# Dual PCI 2.2 Hot-Swap Controllers

## Typical Operating Characteristics (continued)

( $V_{+12VIN} = +12V$ ,  $V_{3.3VAUXIN} = +3.3V$ ,  $V_{-12VIN} = -12V$ ,  $V_{5V} = +5V$ ,  $V_{3.3V} = +3.3V$ ,  $R_{5VSEN} = 0.005\Omega$ ,  $R_{3.3VSEN} = 0.005\Omega$ ,  $C_{3.3VO} =$

MAX5915/MAX5915A/MAX5916/MAX5916A

**AUXILIARY SUPPLY  
TURN-OFF WAVEFORMS**

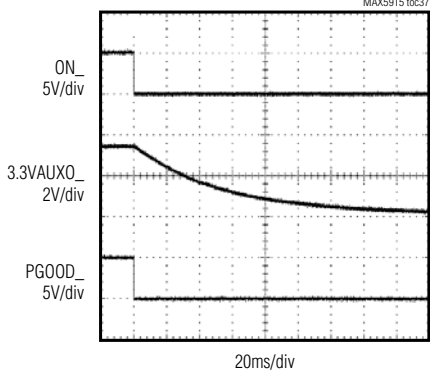

**tDEG DELAY TIME**

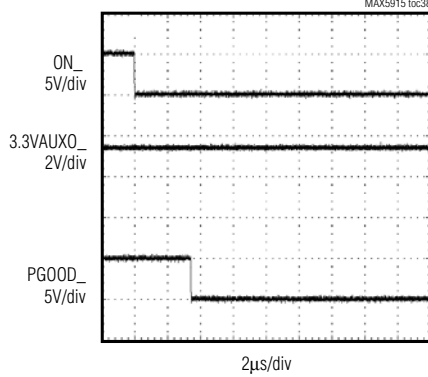

**MAIN SUPPLY  
LATCHED FAULT MANAGEMENT**

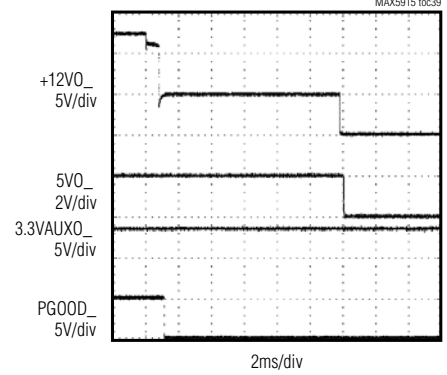

**MAIN SUPPLY  
AUTORESTART FAULT MANAGEMENT**

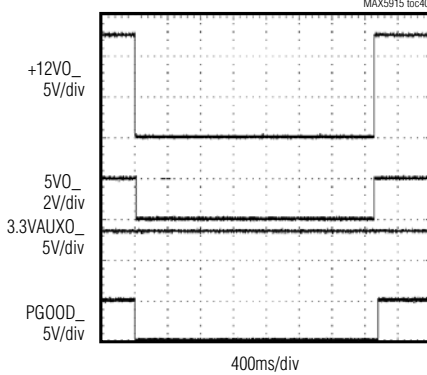

**AUXILIARY SUPPLY  
FAULT MANAGEMENT**

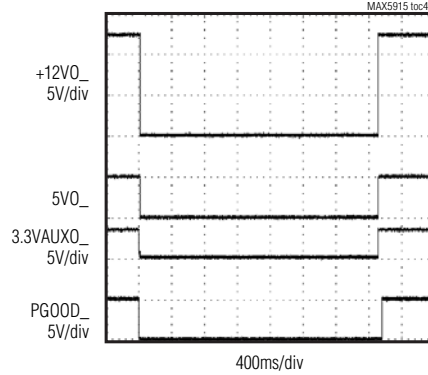

**+12VO\_ IMMEDIATE  
SHORT-CIRCUIT RESPONSE**

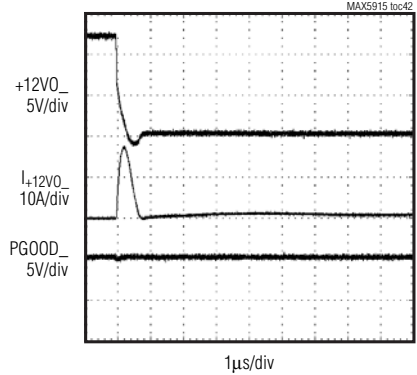

**+12VO\_ CURRENT FOLDBACK**

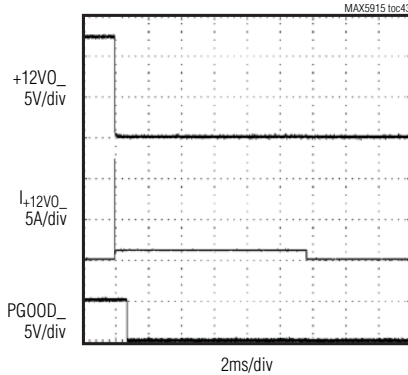

**-12VO\_ IMMEDIATE  
SHORT-CIRCUIT RESPONSE**

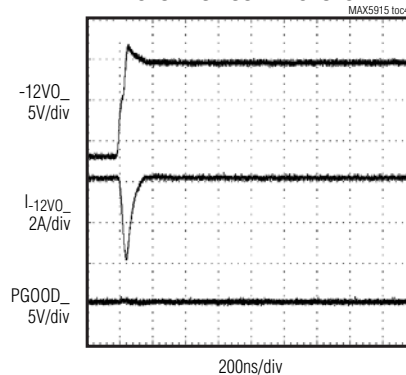

**-12VO\_ CURRENT FOLDBACK**

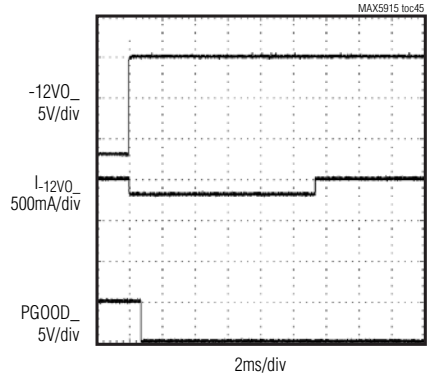

# Dual PCI 2.2 Hot-Swap Controllers

## Typical Operating Characteristics (continued)

( $V_{+12VIN} = +12V$ ,  $V_{3.3VAUXIN} = +3.3V$ ,  $V_{-12VIN} = -12V$ ,  $V_{5V} = +5V$ ,  $V_{3.3V} = +3.3V$ ,  $R_{5VSEN} = 0.005\Omega$ ,  $R_{3.3VSEN} = 0.005\Omega$ ,  $C_{3.3VO} =$

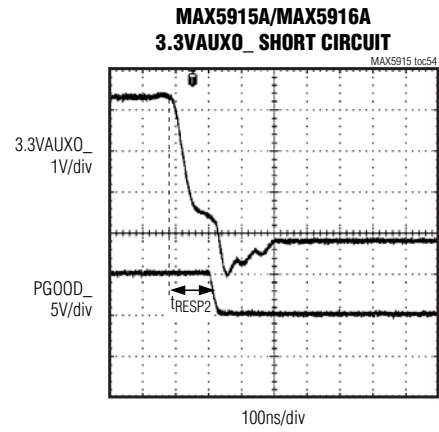
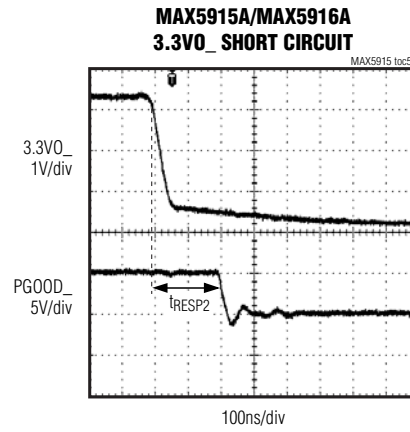
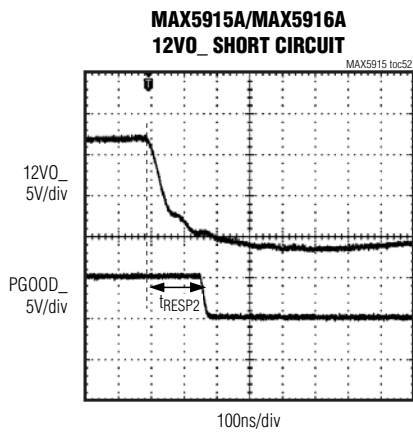
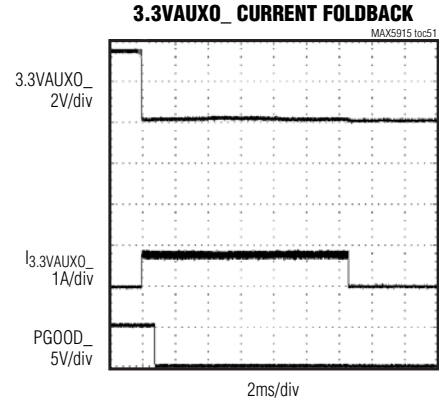
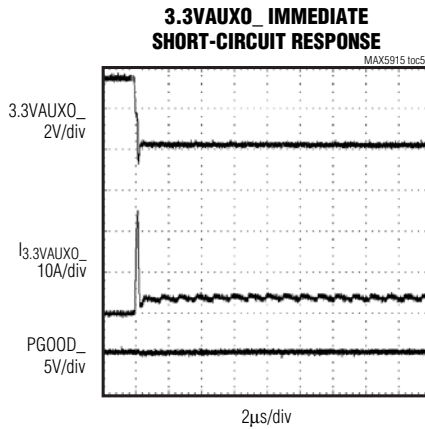
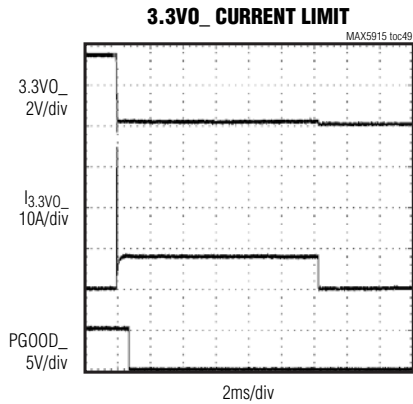
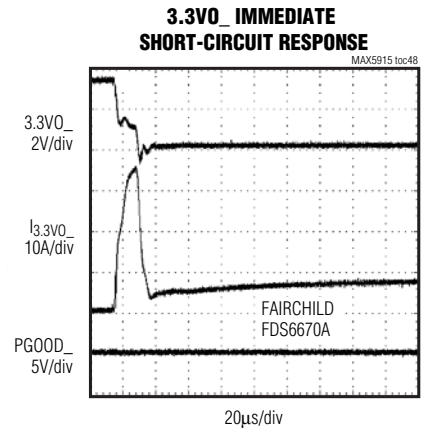
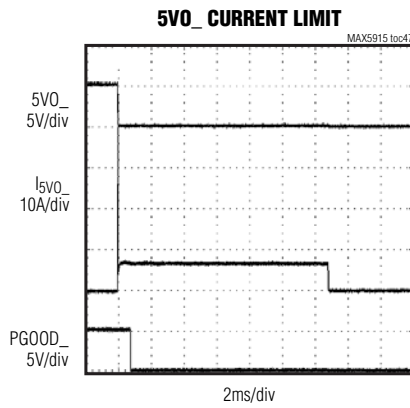
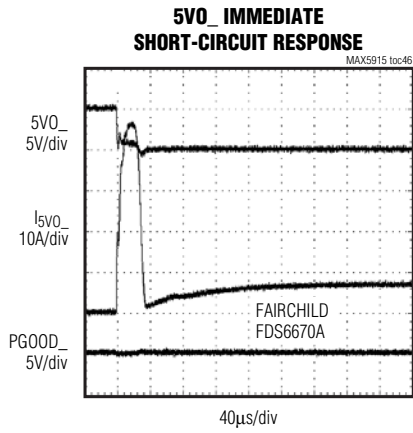

# Dual PCI 2.2 Hot-Swap Controllers

## Pin Description

PIN	NAME	FUNCTION
1	+12VOA	Channel A +12V Output
2	3.3VGATEA	Channel A +3.3V External N-Channel MOSFET Gate Drive. 3.3VGATEA driven by +12VIN.
3	3.3VSENA	Channel A External 3.3V Current-Sense Input
4	3.3VOA	Channel A +3.3V Output Sense
5	ONA	Channel A Master ON/OFF Output Control. Drive ONA logic high to enable channel A +3.3V, +5V, and ±12V outputs. $V_{+12VIN}$ must be > UVLO threshold.
6	ONB	Channel B Master ON/OFF Output Control. Drive ONB logic high to enable channel B +3.3V, +5V, and ±12V outputs. $V_{+12VIN}$ must be > UVLO threshold.
7	GND	Ground
8	PGOODA	Channel A Power-Good Output. PGOODA is an open-drain output that pulls low when a fault is detected on channel A outputs.
9	PGOODB	Channel B Power-Good Output. PGOODB is an open-drain output that pulls low when a fault is detected on channel B outputs.
10	AUXONA	Channel A 3.3VAUX ON/OFF Control Input. Drive AUXONA logic high to enable channel A +3.3V auxiliary output.
11	AUXONB	Channel B 3.3VAUX ON/OFF Control Input. Drive AUXONB logic high to enable channel B +3.3V auxiliary output.
12	3.3VAUXOA	Channel A 3.3VAUX Output
13	3.3VAUXIN	3.3VAUX Input. Provides power to the +3.3V auxiliary channels.
14	3.3VAUXOB	Channel B 3.3VAUX Output
15	-12VOB	Channel B -12V Output
16	-12VIN	-12V Input
17	-12VOA	Channel A -12V Output
18	5VOB	Channel B +5V Output Sense
19	5VSENB	Channel B External +5V Current-Sense Input
20	5VGATEB	Channel B +5V External N-Channel MOSFET Gate Drive. 5VGATEB driven by +12VIN.
21	5VOA	Channel A +5V Output Sense
22	5VSENA	Channel A External +5V Current-Sense Input
23	5VGATEA	Channel A +5V External N-Channel MOSFET Gate Drive. 5VGATEA driven by +12VIN.
24	3.3VOB	Channel B +3.3V Output Sense
25	3.3VSENB	Channel B External +3.3V Current-Sense Input
26	3.3VGATEB	Channel B +3.3V External N-Channel MOSFET Gate Drive. 3.3VGATEB driven by +12VIN.
27	+12VOB	Channel B +12V Output
28	+12VIN	+12V Input. +12VIN powers the main supplies of the MAX5915/MAX5915A/MAX5916/MAX5916A.

MAX5915/MAX5915A/MAX5916/MAX5916A

# Dual PCI 2.2 Hot-Swap Controllers

**Table 1. PCI Standard Maximum Values**

SUPPLY VOLTAGE (V)*	VOLTAGE TOLERANCE (%)	MAX CURRENT (A)	MAX POWER (W)
+5	±5	5	25
+3.3	±0.3V	7.6	25
+12	±5	0.5	6
-12	±10	0.1	1.2
+3.3 aux (enabled)	±10	0.375	1.24
+3.3 aux (disabled)	±10	0.02	0.066

\*Supply voltage is referenced to the output of the MAX5915/MAX5916.

## Detailed Description

The MAX5915/MAX5915A/MAX5916/MAX5916A are circuit-breaker ICs for hot-swap applications where a PCI card is inserted into a slot that is connected to a live backplane. Normally, when a card is plugged into a live backplane, the card's discharged capacitors provide a low-impedance path that can momentarily cause the main power supply to collapse. Both devices provide startup current limiting and undervoltage/overcurrent monitoring of two separate PCI card slots. Current limiting and short-circuit protection are achieved using external n-channel MOSFETs on the +3.3V and +5V supply lines and internal MOSFETs on the ±12V and +3.3V auxiliary supply lines.

External sense resistors monitor the output currents of the +3.3V and +5V supplies. These external sense resistors adjust the overcurrent trip threshold. PCI standards dictate maximum values for the supply power and total power drawn from the backplane. The maximum power that any one PCI board can draw is 25W. Table 1 lists PCI standard maximum voltage, current, and power for each supply.

Table 1 illustrates that both the +5V and +3.3V supplies can draw up to 25W. Total combination of output power should be limited to 25W based on PCI standard.

### Startup Mode

The +12V input powers the internal circuitry of these devices. The main supply outputs (3.3VO<sub>-</sub>, 5VO<sub>-</sub>, +12VO<sub>-</sub>, and -12VO<sub>-</sub>) can become active only after both of the following events have occurred:

- V<sub>+12VIN</sub> is above its undervoltage lockout (UVLO) threshold.
- ON<sub>-</sub> is driven high.

Figure 1 displays typical startup waveforms. The main supplies can be enabled without using the auxiliary supply; however, PGOOD<sub>-</sub> remains in a low state if the

auxiliary supply is not used.

The auxiliary supply (3.3VAUXO<sub>-</sub>) is available after both of these events have occurred:

- V<sub>3.3VAUXIN</sub> is above its UVLO threshold.
- AUXON<sub>-</sub> is driven high.

### Normal Operation +3.3V, +5V, ±12V Outputs

The internal circuitry for these devices monitors the output voltage on all channels except the -12V supply. All outputs are monitored for overcurrent. An undervoltage condition occurs when any supply's output voltage falls below the set undervoltage level. An overcurrent fault occurs when a monitored output current reaches the set overcurrent threshold. Each supply has its own overcurrent and undervoltage thresholds. If any of the monitored voltages fall below their respective undervoltage level, or if any of the monitored output currents reach their overcurrent threshold, for a time period, t<sub>DELAY</sub>, the controller disables the channel with the fault condition (see the *Fault Management* section).

External sense resistors monitor current through the external MOSFETs of the +3.3V and +5V outputs, while the current for the ±12V supplies are internally monitored. A fault condition on one of the main outputs causes all the channel's main outputs to shut down after t<sub>DELAY</sub> and then either latch off (MAX5915/MAX5915A) or automatically restart after t<sub>RESTART</sub> (MAX5916/MAX5916A). A fault on any of the channel's main outputs **does not** affect the channel's auxiliary outputs.

### Normal Operation +3.3V Auxiliary Output

Auxiliary output voltage and current are monitored internally. The +3.3V auxiliary output is **independent** of the main outputs but the main outputs are **dependent** on the auxiliary outputs. Fault conditions on the main outputs do not affect the auxiliary. A fault on the auxiliary supply causes the controller to disable all of the affected

# Dual PCI 2.2 Hot-Swap Controllers

MAX5915/MAX5915A/MAX5916/MAX5916A

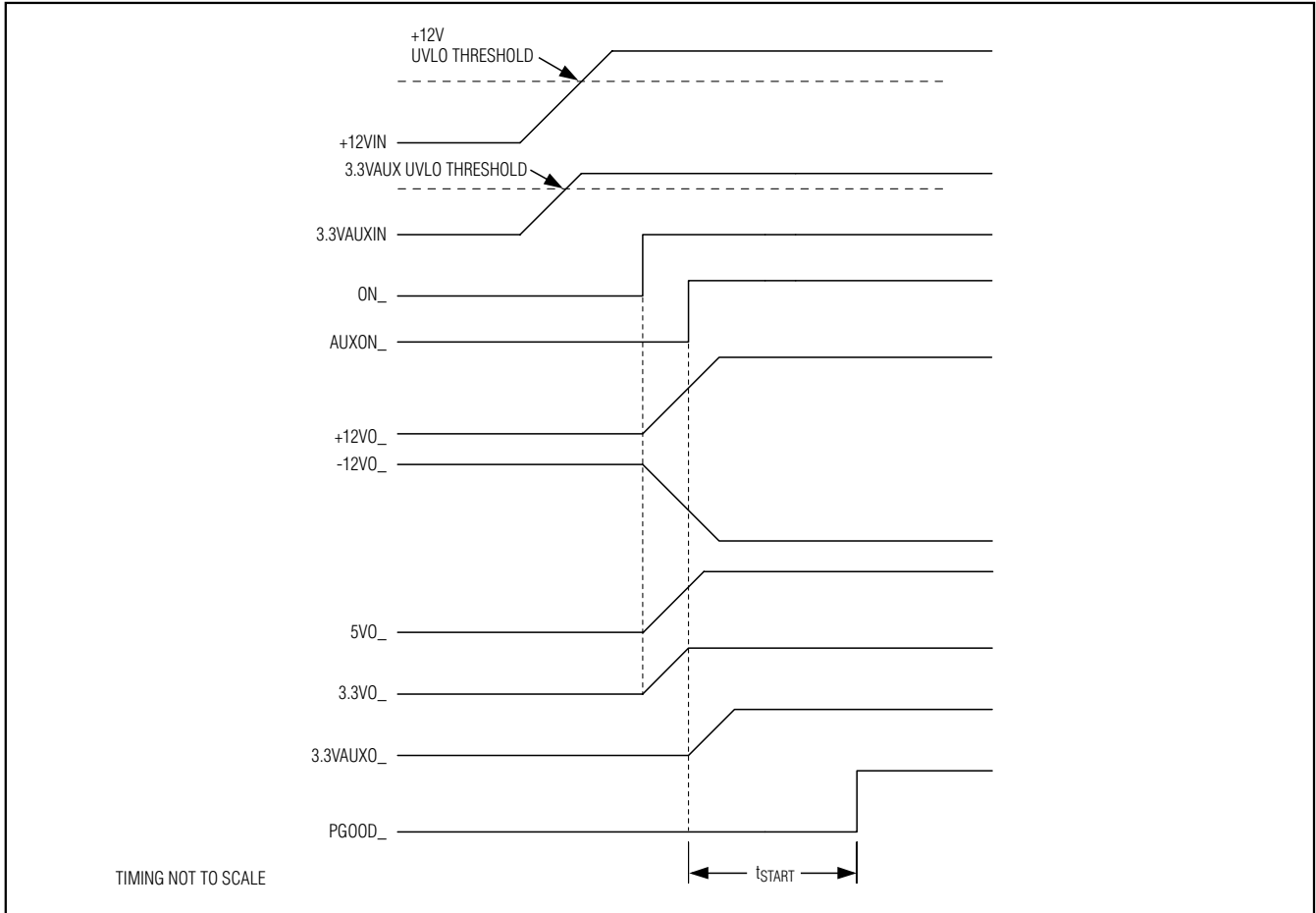

Figure 1. Startup Waveforms

channel outputs, auxiliary and main. A fault condition occurs when the output voltage falls below the set undervoltage threshold or the output current reaches the overcurrent threshold. When a fault occurs, all supplies of the affected channel are disabled after a time period  $t_{DELAY}$ . All outputs are automatically restarted after a time equal to  $t_{RESTART}$ . This reset is built into all devices.

### Current Limits

All supplies are protected against output overcurrent or short-circuit conditions. The MAX5915/MAX5915A and MAX5916/MAX5916A employ a "brickwall" current limit on the +3.3V and +5V supplies and a current-foldback scheme on the  $\pm 12V$  and +3.3V auxiliary supplies.

### Brickwall

A brickwall current limit protects the +3.3V and +5V main supplies by limiting the load current. The external

sense resistors and the current-limit threshold set the brickwall current limits. A fault occurs when the load current reaches the brickwall limit. The main outputs shut down after  $t_{DELAY}$  if the fault remains. The brick-wall feature limits inrush current caused by positive supply voltage steps.

### Foldback

The  $\pm 12V$  and +3.3V auxiliary supplies employ an internal current-foldback scheme. The MAX5915/MAX5915A/MAX5916/MAX5916A gradually limit the load current once the current-foldback threshold is reached. If the overcurrent condition lasts longer than a fast transient, the output current is reduced to the foldback current limit and remains at that level for  $t_{DELAY}$  unless the overcurrent condition is cleared. See the *Typical Operating Characteristics*.

## Dual PCI 2.2 Hot-Swap Controllers

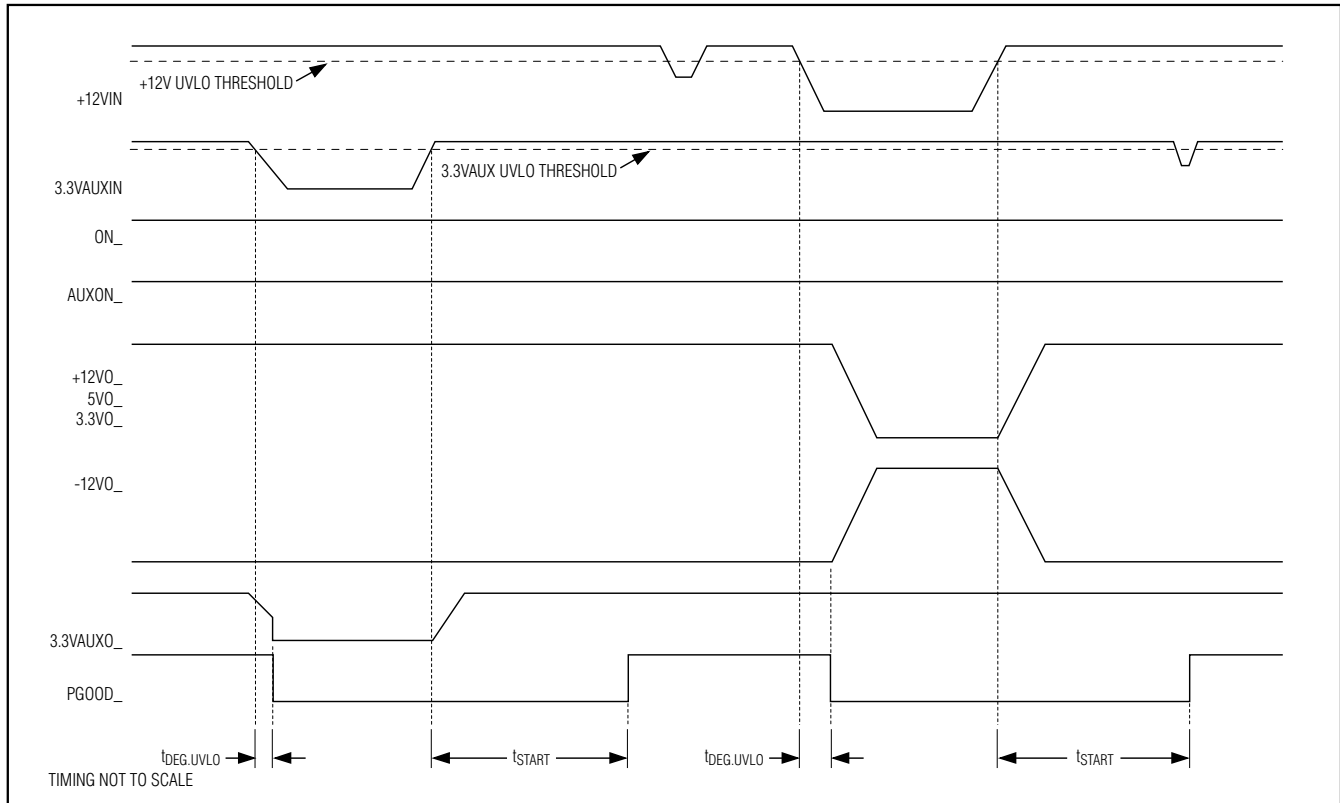

Figure 2. Input UVLO Fault Management in the MAX5915/MAX5915A/MAX5916/MAX5916A

### Input Undervoltage Lockout

UVLO prevents these devices from turning on internal/external MOSFETs until the input voltage exceeds the lockout threshold. The UVLO protects the MOSFETs from insufficient gate-drive voltage. Figure 2 shows that if an input undervoltage condition exists for more than  $t_{DEG,UVLO}$ , the outputs are disabled and PGOOD\_ goes low immediately. The time delay  $t_{DEG,UVLO}$  is negative edge delayed and acts as a deglitch.

### Fault Management

When a fault is detected on one of the main outputs, the MAX5915/MAX5915A/MAX5916/MAX5916A disable the channel outputs after  $t_{DELAY}$ . A fault occurs when any of the output voltages fall below their output undervoltage threshold or any of the output currents exceed their output overcurrent threshold. PGOOD\_ pulls low if a fault persists for more than  $t_{RESP}$ . The channel with the fault is disabled after  $t_{DELAY}$ . The MAX5915/MAX5916 are available with a response time of 1.5ms ( $t_{RESP}$ ). The MAX5915A/MAX5916A offer a response time of 100ns ( $t_{RESP2}$ ). If the fault is removed before  $t_{DELAY}$ , the channel remains on and PGOOD\_ pulls high immediately.

### Latched Fault Protection

The MAX5915/MAX5915A latch off the appropriate channel's main outputs. Toggling +12VIN or ON\_ restarts the main outputs. Figure 3 outlines the logic for the main and auxiliary shutdown control of the MAX5915, while fault handling is shown in Figures 5 and 6.

### Autoretry Fault Protection

The MAX5916/MAX5916A automatically restart the outputs after  $t_{RESTART}$ . The MAX5915/MAX5915A/MAX5916/MAX5916A handle faults on the auxiliary outputs by automatically restarting the appropriate channel. Figure 4 outlines the logic for the main and auxiliary shutdown control of the MAX5916, while fault handling is shown in Figures 6 and 7.

### Output Overcurrent

External sense resistors monitor the current on the +5V and +3.3V outputs, while the +3.3V auxiliary and  $\pm 12V$  output currents are monitored internally. Figures 5, 6, and 7 show overcurrent fault management for the MAX5915/MAX5915A/MAX5916/MAX5916A.

# Dual PCI 2.2 Hot-Swap Controllers

MAX5915/MAX5915A/MAX5916/MAX5916A

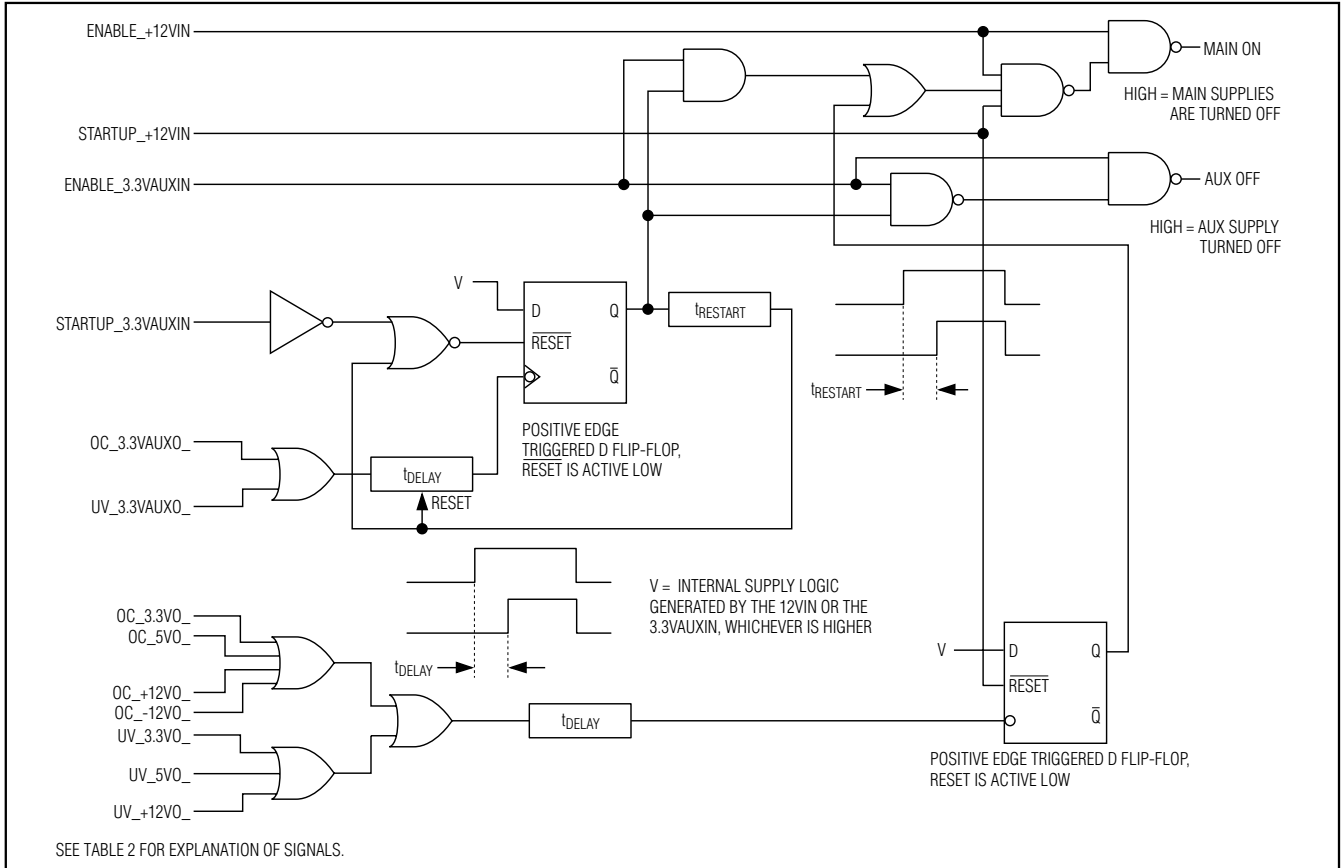

Figure 3. Main and Auxiliary Supply Shutdown Control Logic for MAX5915/MAX5915A

## Output Undervoltage

The output voltages on all supplies, except the -12V supply, are monitored for undervoltage. Output undervoltage fault management is identical to the output overcurrent fault management. Figures 5, 6, and 7 can be used to illustrate undervoltage faults on the MAX5915/MAX5915A/MAX5916/MAX5916A.

## Thermal Shutdown Control

The MAX5915/MAX5915A/MAX5916/MAX5916A feature internal thermal protection. Two thresholds detect when the device is overheated. If the first threshold is reached, the channel that is in overcurrent shuts down. If the second thermal threshold is reached, the entire device shuts down. The device cannot be restarted until the thermal condition is cleared. For the MAX5915, the main channels turn back on after +12VIN or ON\_ is toggled. For the MAX5916, the main channels turn back on after tRESTART. The auxiliary channels for the MAX5915/MAX5915A/MAX5916/MAX5916A restart after tRESTART.

## PGOOD\_ Operation

The MAX5915/MAX5915A/MAX5916/MAX5916A incorporate a PGOOD\_ output to report when power is good to a microprocessor or controller. PGOOD\_ remains low if the auxiliary outputs are not powered, for PCI and compact PCI systems where the 3.3VAUX is not available. Connect 3.3VAUXIN to 3.3VIN and connect AUXON\_ to ON\_ to allow PGOOD\_ to transition high when the main supplies are available. The open-drain structure of PGOOD\_ requires an external pullup resistor (see the *Functional Diagram*). Figure 8 shows the internal logic of the PGOOD\_ output.



# Dual PCI 2.2 Hot-Swap Controllers

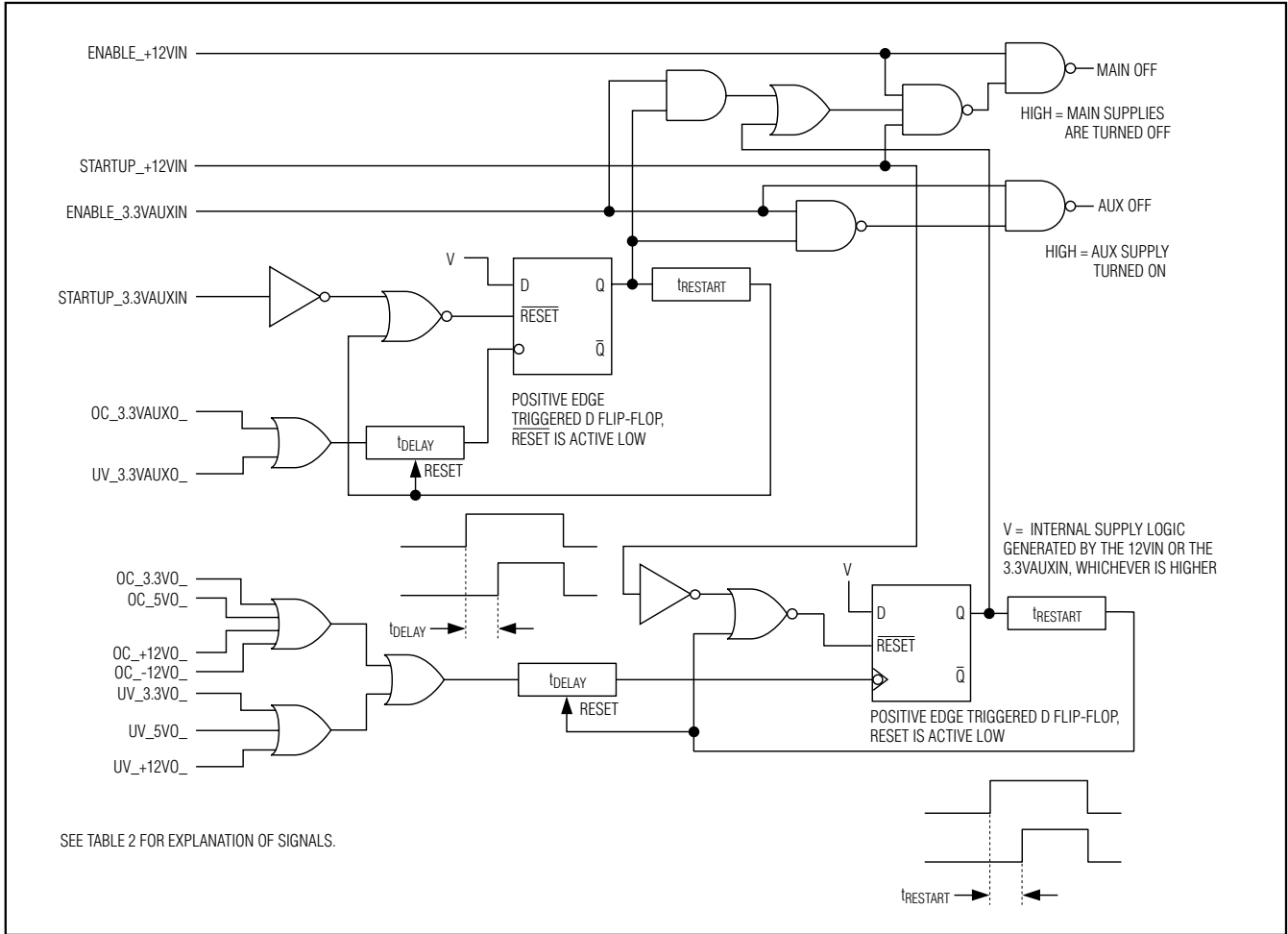

Figure 4. Main and Auxiliary Supply Shutdown Control Logic for MAX5916/MAX5916A

## Applications Information

### Component Selection

#### External MOSFETs

Select the external n-channel MOSFETs according to the application's current requirement. Limit switch power dissipation by choosing a MOSFET with an  $R_{DS(ON)}$  low enough to have a minimum voltage drop at full load. High  $R_{DS(ON)}$  causes output ripple if the board has pulsing loads. High  $R_{DS(ON)}$  can trigger an external undervoltage fault at full load. Determine the MOSFET's power rating requirement to accommodate a short-circuit condition on the board during startup (see the *External MOSFET Thermal Considerations* section). Table 3 lists MOSFET and sense resistor manufacturers.

#### Sense Resistors

The overcurrent sense voltage threshold on the +3.3V output is 46mV and 31mV on the +5V output. Choose a sense resistor using the following equation:

$$R_{SENSE} = (V_{ILIM} / I_{LOAD})$$

where  $I_{LOAD}$  is the brickwall current limit for the output. Choose the sense resistors' power rating to accommodate the overload current:

$$P_{SENSE} = (I_{LOAD})^2 \times R_{SENSE}$$

#### Additional External Gate Capacitance

Connecting an external capacitance from the gates of the external MOSFETs to GND slows the turn on of the +5V and +3.3V supplies.



# Dual PCI 2.2 Hot-Swap Controllers

MAX5915/MAX5915A/MAX5916/MAX5916A

**Table 2. Logic Diagram Signal Descriptions**

SIGNAL NAME	DESCRIPTION
Enable_+12VIN	Signal is HIGH: 1. +12VIN > V <sub>UVLO, +12V</sub> 2. ON_ = HIGH 3. Thermal shutdown NOT active
Startup_+12VIN	Signal is HIGH: 1. +12VIN > V <sub>UVLO, +12V</sub> 2. ON_ = HIGH 3. t <sub>START</sub> has elapsed
Enable_3.3VAUXIN	Signal is HIGH 1. 3.3VAUXIN > V <sub>UVLO, AUX</sub> 2. AUXON_ = HIGH 3. Thermal shutdown NOT active
Startup_3.3VAUXIN	Signal is HIGH: 1. 3.3VAUXIN > V <sub>UVLO, AUX</sub> 2. AUXON_ = HIGH 3. t <sub>START</sub> has elapsed
OC_	Signal is HIGH when an overcurrent condition exists on the output of the supply.
UV_	Signal is HIGH when an undervoltage condition exists on the output of the supply.

### Maximum Load Capacitance

Large capacitive loads can cause a problem when inserting discharged PCI cards into the live backplane. If the time needed to charge the capacitance of the board is greater than the typical startup time, 50ms, a fault can occur after startup.

The MAX5915/MAX5915A/MAX5916/MAX5916A are able to withstand large capacitive loads due to their long start-up time. Each supply has its own current-limit threshold. Calculate the maximum load capacitance as follows:

$$C_{BOARD} < 50\text{ms} \times I_{LIM} / V_{SUPPLY}$$

### Input Transients

The +12V and +3.3VAUX supplies must be above their respective UVLO thresholds before startup can occur. Input transients can cause the input voltage to sag below the UVLO threshold. The MAX5915/MAX5915A/MAX5916/MAX5916A reject input transients that are shorter than t<sub>DEG</sub>, UVLO.

### External MOSFET Thermal Considerations

The power dissipation of the external MOSFET is low when it is on, P<sub>D</sub> = I<sub>LOAD</sub><sup>2</sup> × R<sub>DS(ON)</sub>. A considerable amount of power is dissipated during startup and continuous short-circuit conditions. The design must take into consideration the worst-case scenario.

### Layout Considerations

To take full advantage of the switch response time to an output fault condition, keep all traces as short as possible and maximize the high-current trace dimensions to reduce the effect of undesirable parasitic inductance. Place the MAX5915/MAX5915A/MAX5916/MAX5916A close to the PCI card's connector. Use a ground plane to minimize impedance and inductance. Minimize the current-sense resistor trace length and ensure accurate current sensing with Kelvin connections (Figure 9).

When an output is short circuited, the voltage drop across the external MOSFET becomes large. Hence the power dissipation across the switch and die temperature both increase. An efficient way to achieve good power dissipation on a surface-mount package is to lay out two copper pads directly under the package on both sides of the board. Connect the two pads to the ground plane through vias, and use enlarged copper mounting pads on the topside of the board.

### Chip Information

TRANSISTOR COUNT: 1021

PROCESS: BiCMOS

# Dual PCI 2.2 Hot-Swap Controllers

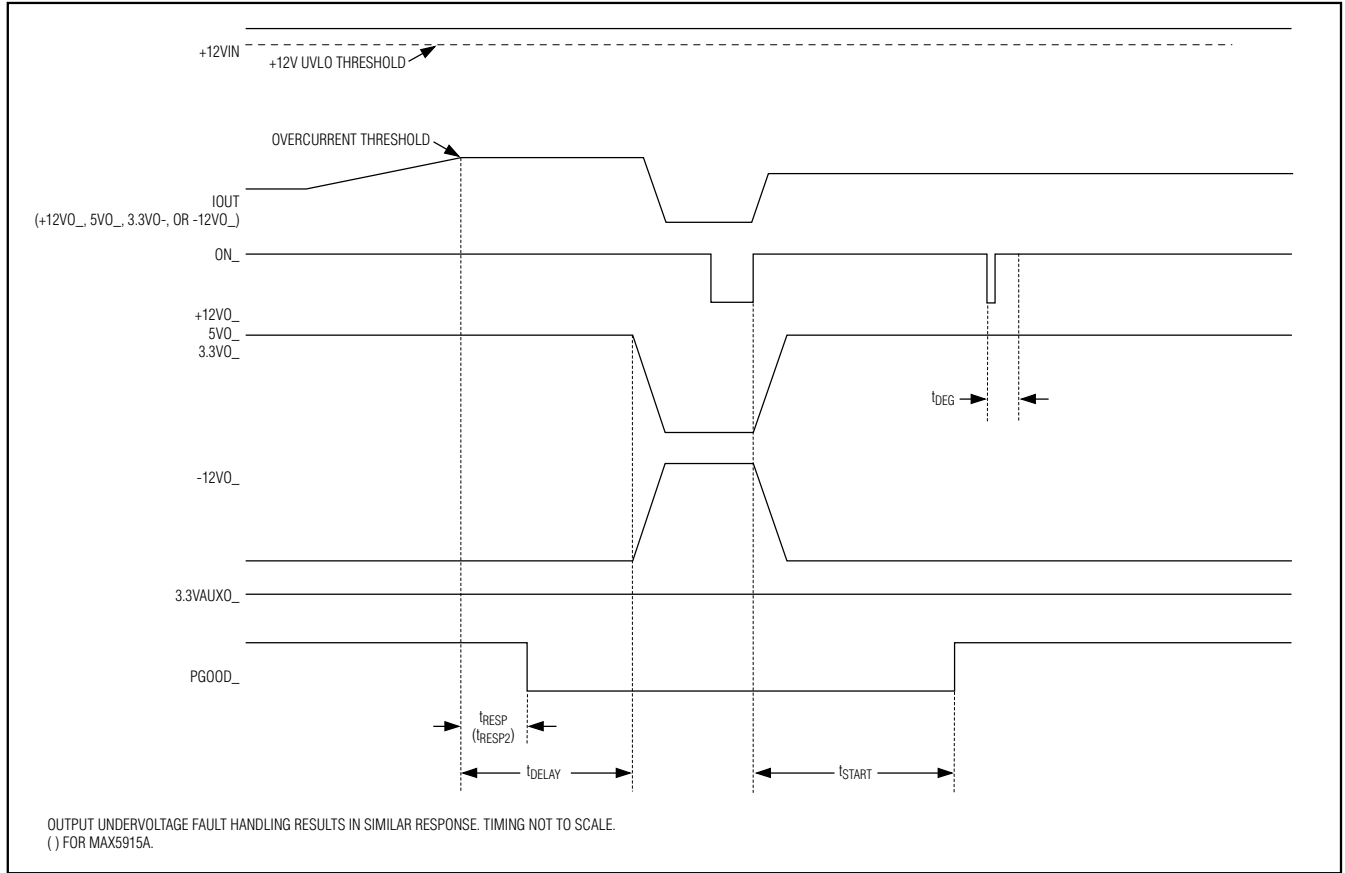

Figure 5. Main Outputs Overcurrent Fault Management in the MAX5915/MAX5915A

# Dual PCI 2.2 Hot-Swap Controllers

MAX5915/MAX5915A/MAX5916/MAX5916A

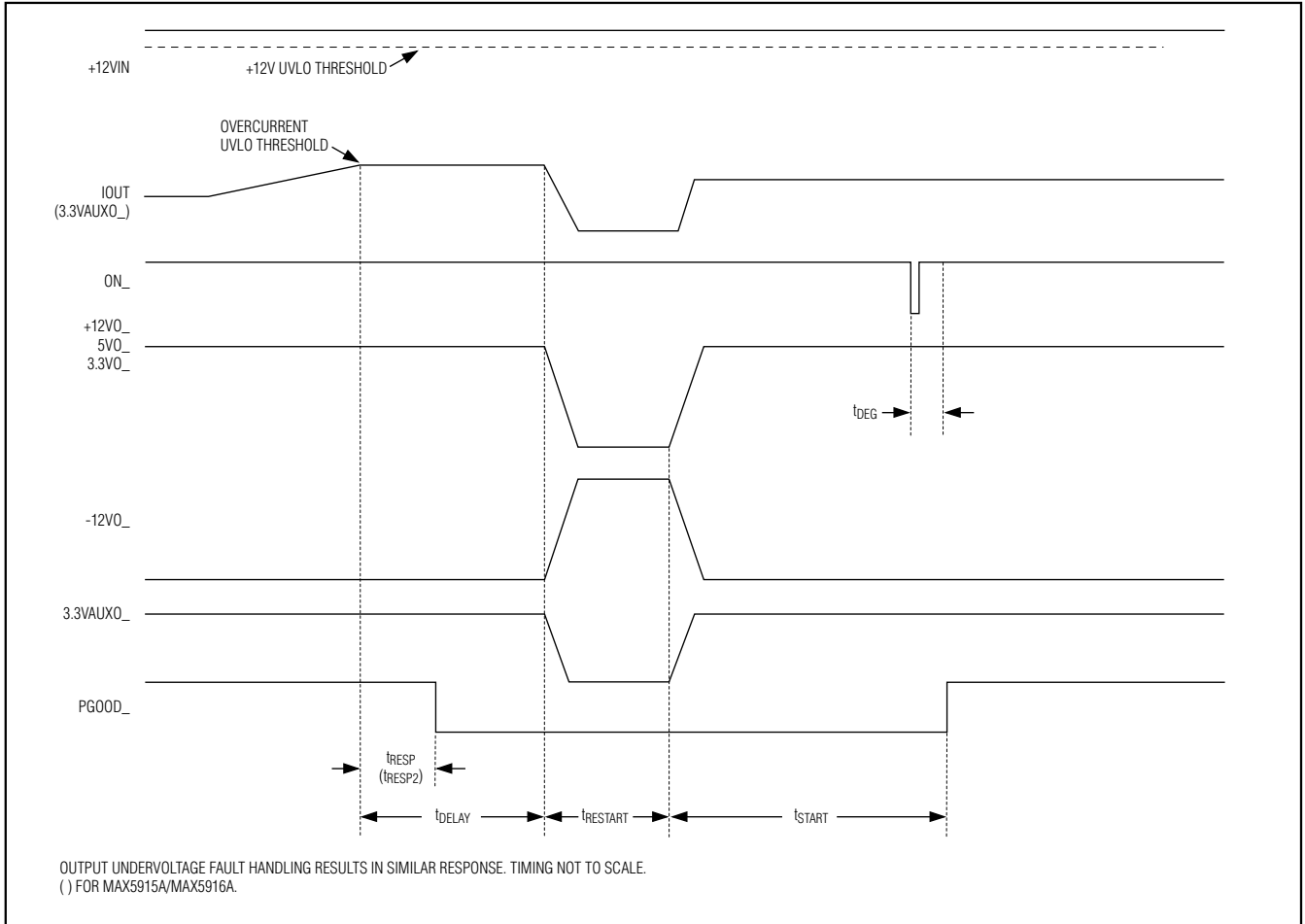

Figure 6. Auxiliary Outputs Overcurrent Fault Management in the MAX5915/MAX5915A/MAX5916/MAX5916A

# Dual PCI 2.2 Hot-Swap Controllers

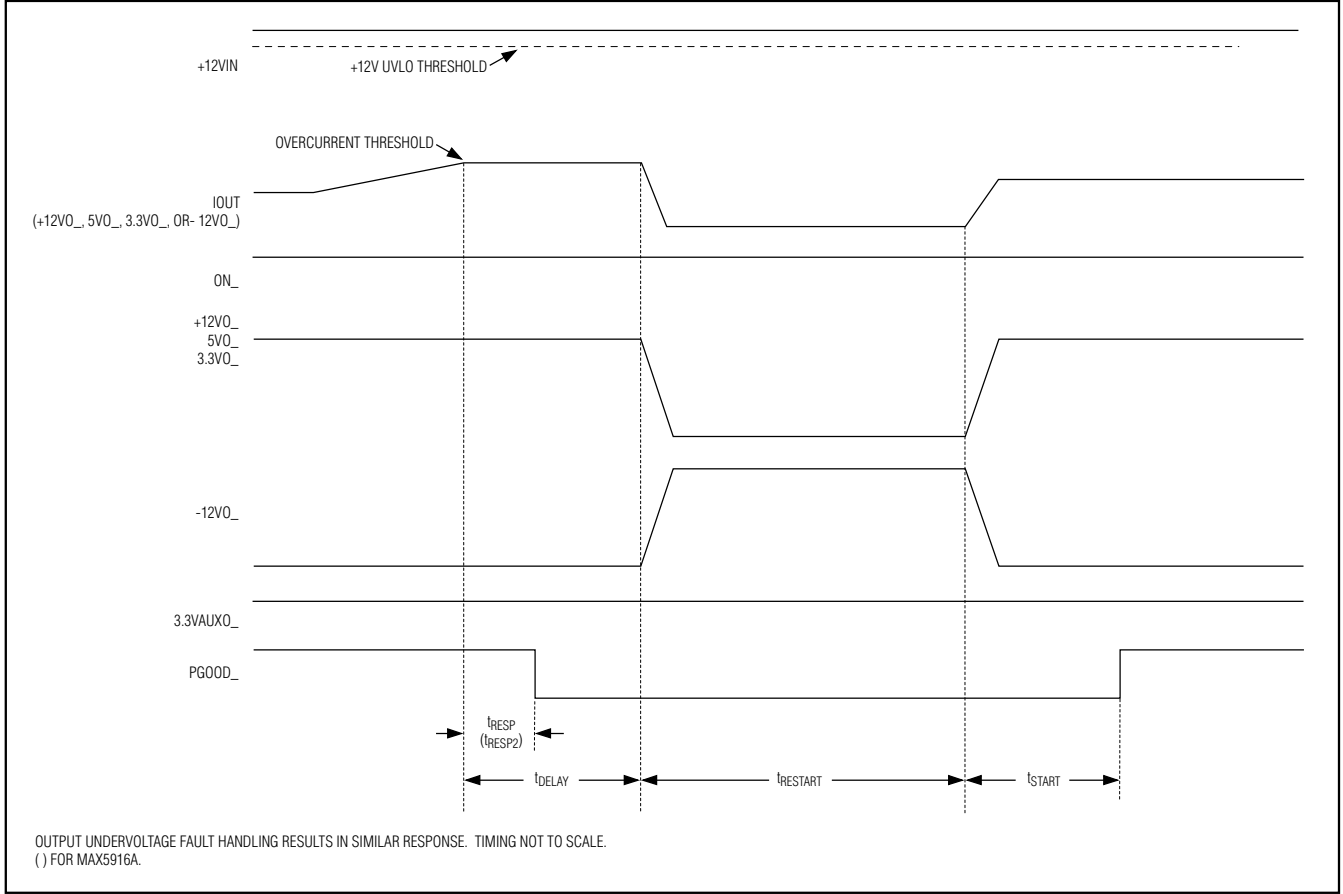

Figure 7. Main Outputs Overcurrent Fault Handling in the MAX5916/MAX5916A

# Dual PCI 2.2 Hot-Swap Controllers

MAX5915/MAX5915A/MAX5916/MAX5916A

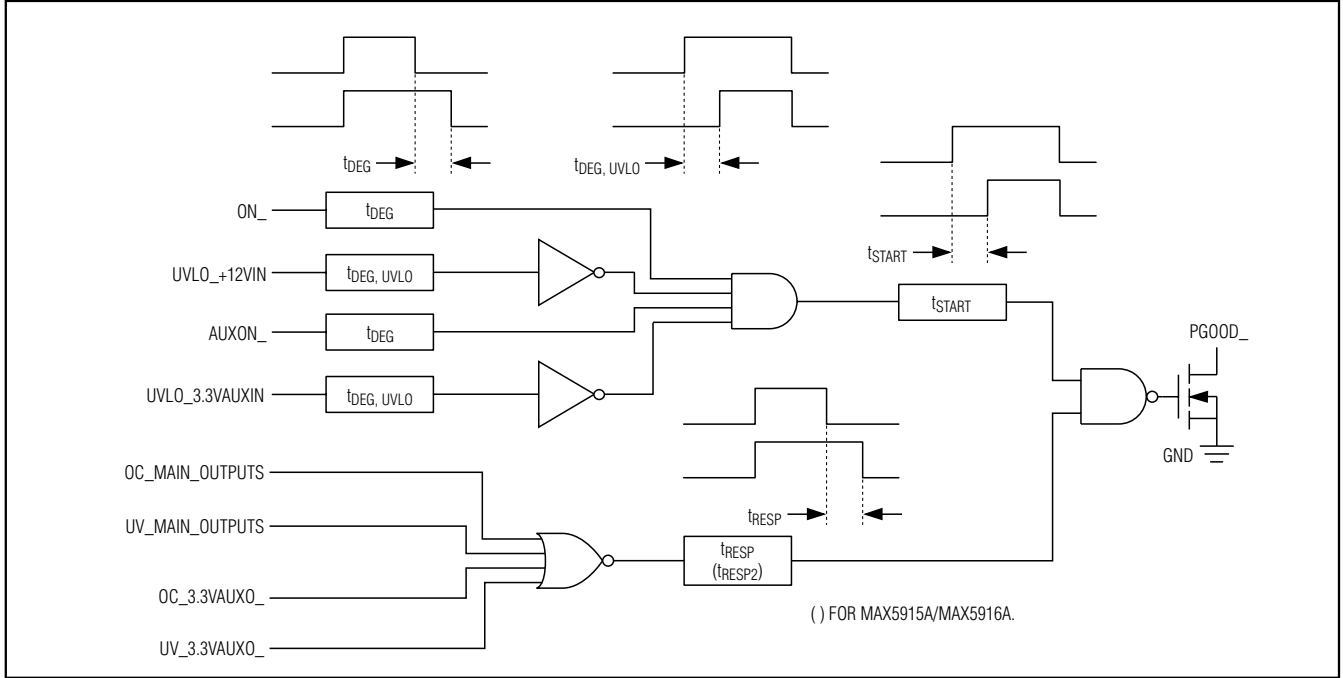

Figure 8.  $PGOOD_$  Logic Diagram

# Dual PCI 2.2 Hot-Swap Controllers

**Table 3. Component Manufacturers**

COMPONENT	MANUFACTURER	PHONE	WEBSITE
Sense Resistors	Dale-Vishay	402-564-3131	www.vishay.com
	IRC	704-264-8861	www.irctt.com
MOSFETs	Fairchild	888-522-5372	www.fairchildsemi.com
	International Rectifier	310-322-3331	www.irf.com
	Motorola	602-244-3576	www.mot-sps.com/ppd/

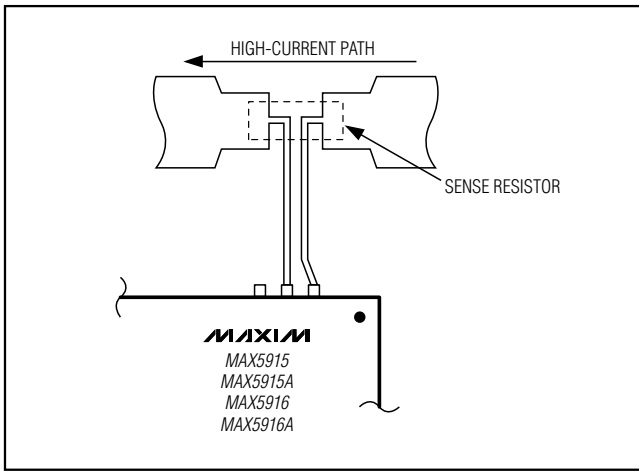
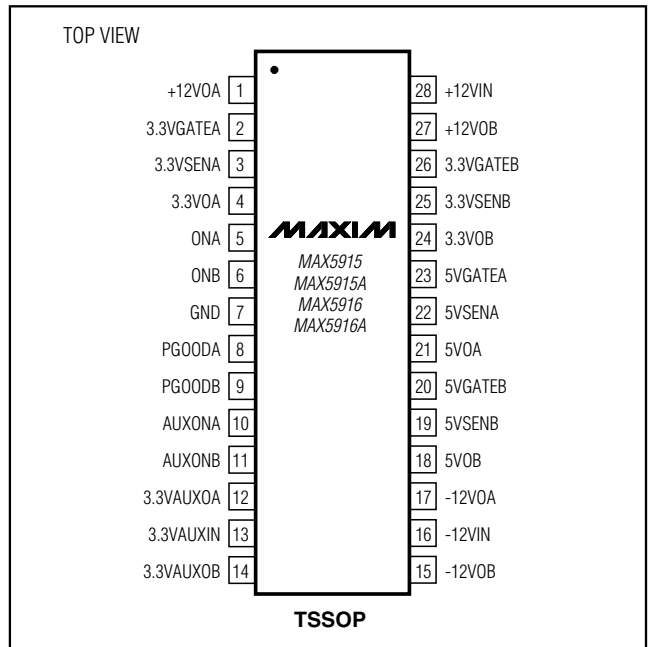

Figure 9. Kelvin Connections for Sense Resistors

## Selector Guide

PART	FAULT MANAGEMENT	PGOOD_ FAULT RESPONSE TIME (S)
MAX5915EUI	Latched	1.5m
MAX5915AEUI	Latched	100n
MAX5916EUI	Autorestart	1.5m
MAX5916AEUI	Autorestart	100n

## Pin Configuration



# Dual PCI 2.2 Hot-Swap Controllers

## Typical Operating Circuit

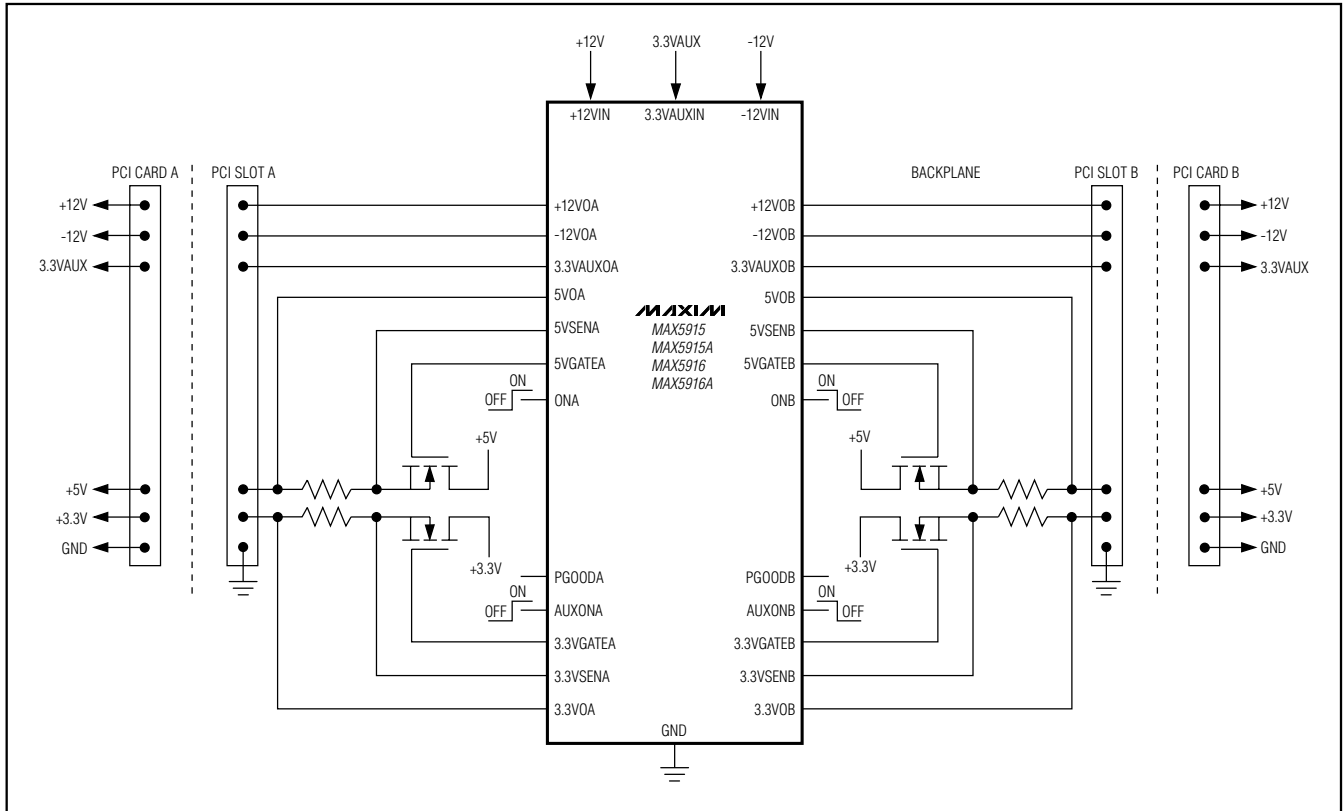

MAX5915/MAX5915A/MAX5916/MAX5916A

# Dual PCI 2.2 Hot-Swap Controllers

Functional Diagram

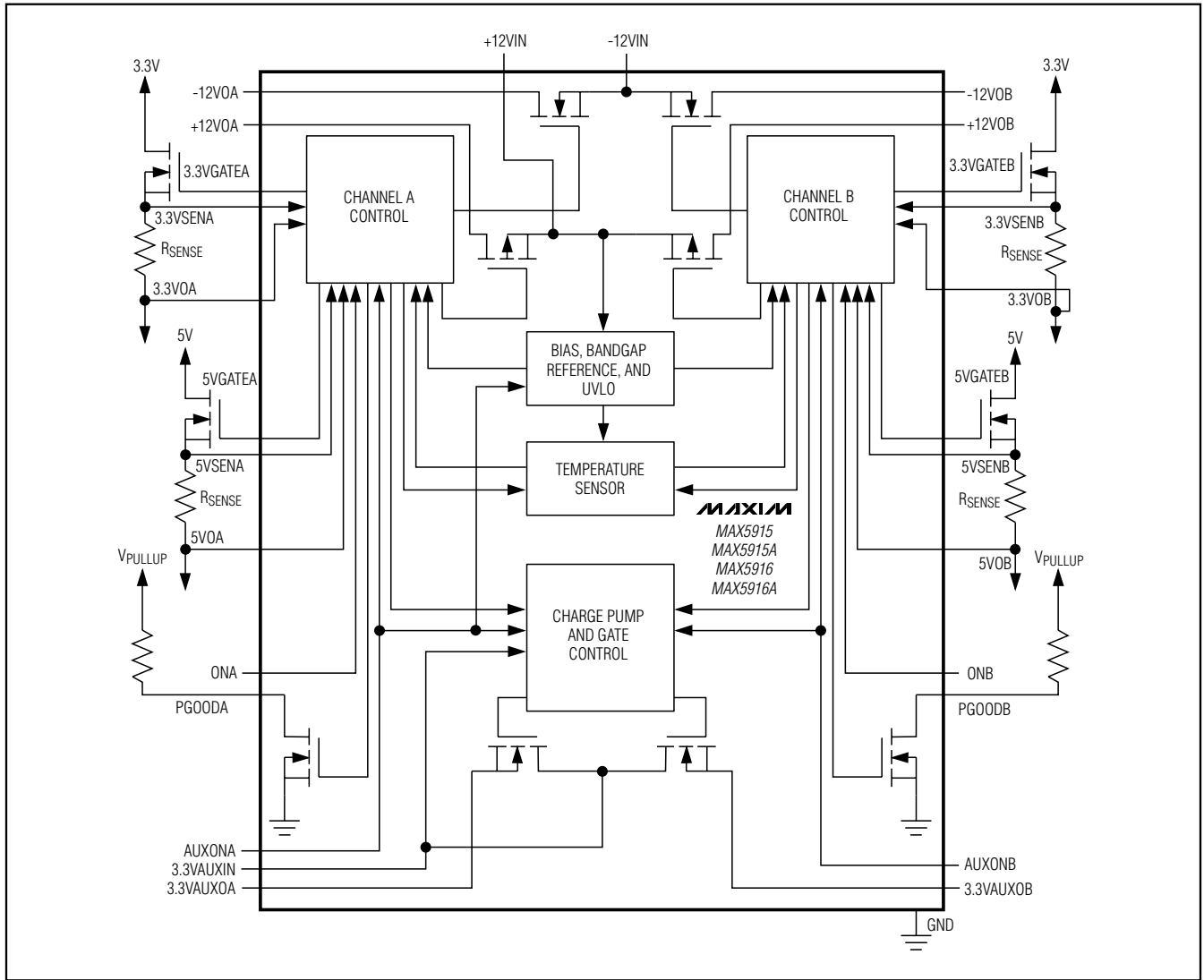



# Dual PCI 2.2 Hot-Swap Controllers

## Package Information

(The package drawing(s) in this data sheet may not reflect the most current specifications. For the latest package outline information, go to [www.maxim-ic.com/packages](http://www.maxim-ic.com/packages).)

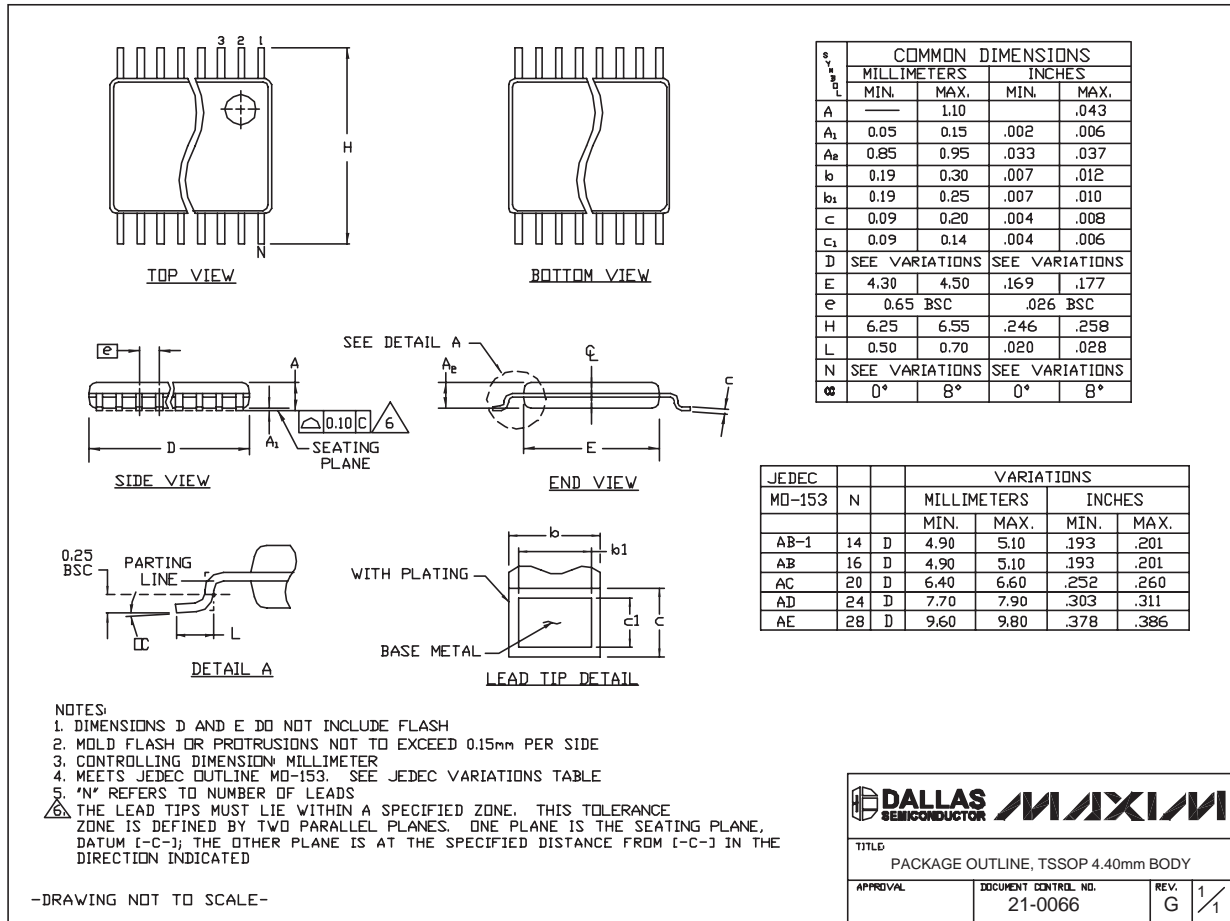

TSSOP4.40mm.EPS

MAX5915/MAX5915A/MAX5916/MAX5916A

Maxim cannot assume responsibility for use of any circuitry other than circuitry entirely embodied in a Maxim product. No circuit patent licenses are implied. Maxim reserves the right to change the circuitry and specifications without notice at any time.

Maxim Integrated Products, 120 San Gabriel Drive, Sunnyvale, CA 94086 408-737-7600 \_\_\_\_\_ 25